

Install Speakers

CMS 1201DCT

12" Full Range Ceiling Loudspeaker with Dual Concentric Driver and Transformer for Installation Applications

- Full range ceiling loudspeaker for installation applications
- 200 Watts continuous, 800 Watts peak power
- 12" Dual Concentric full range driver for point source phase coherence
- 90° constant directivity dispersion for optimum coverage
- Multiple transformer taps for 70 V and 100 V line systems or 8 Ohm direct input
- Low insertion loss 60 W line transformer
- For use with CMS 1201 back can and grille assembly (available separately)
- Back can fixings allow multiple installation options
- Time-saving design enables one person speaker installation
- 10-Year Warranty Program*
- Designed and engineered in the U.K.



The CMS 1201DCT is a full bandwidth 800-Watt high sensitivity loudspeaker that utilises our proprietary 12" Dual Concentric point-source driver, which delivers consistent broadband directivity (90° conical) with enhanced intelligibility – plus highly accurate and linear response.



Full Range Driver

CMS 1201DCT's 12" (300 mm) Dual Concentric constant directivity driver features a treated cone, plus a 1.34" (34 mm) aluminium dome with neodymium magnet system for powerful and highly intelligible music and speech reproduction. Frequency response ranges from 60 Hz - 20 kHz (-3 dB) with a maximum SPL of 126 dB (1 m, on axis). A low insertion loss 60 W line transformer multiple taps is provided for 70V and 100V line systems, as well as an 8 Ohm direct input.

Install Speakers

CMS 1201DCT

12" Full Range Ceiling Loudspeaker with Dual Concentric Driver and Transformer for Installation Applications

Optimised for Installation

The custom-engineered powder coated steel back-can and grille assembly (available separately) has been designed to cater to all conceivable installation possibilities, making the CMS 1201DCT extremely versatile. The internally-dampened 79 litre (2.8 cubic feet) back-can provides exceptional LF performance that is easily on par with conventional wooden enclosure loudspeakers. Steel mounting lugs allow for fitting to a Unistrut roof rail system or for suspension via 4 top-mounted eye bolts. Alternatively, the design allows for a single point suspension, which can be handled via the use of M10 or 3/8" UNC screwed rod. Connection is quick and simple using terminal barrier strips inside the can, which are easily accessed via 20 and 29 mm conduit knockouts on all 5 sides. Installation can be facilitated by a single person, which can amount to considerable savings in large-scale projects.



LAB GRUPPEN Ready

The CMS 1201DCT is optimised to work in conjunction with [LAB GRUPPEN](#) amplification.

You Are Covered

We always strive to provide the best possible Customer Experience. Our products are made in our own [MUSIC Tribe](#) factory using state-of-the-art automation, enhanced production workflows and quality assurance labs with the most sophisticated test equipment available in the world. As a result, we have one of the lowest product failure rates in the industry, and we confidently back it up with a generous [Warranty](#) program.



Install Speakers

CMS 1201DCT

12" Full Range Ceiling Loudspeaker with Dual Concentric Driver and Transformer for Installation Applications

Frequency Response Sensitivity 1 W / 1 m (IEC baffle)

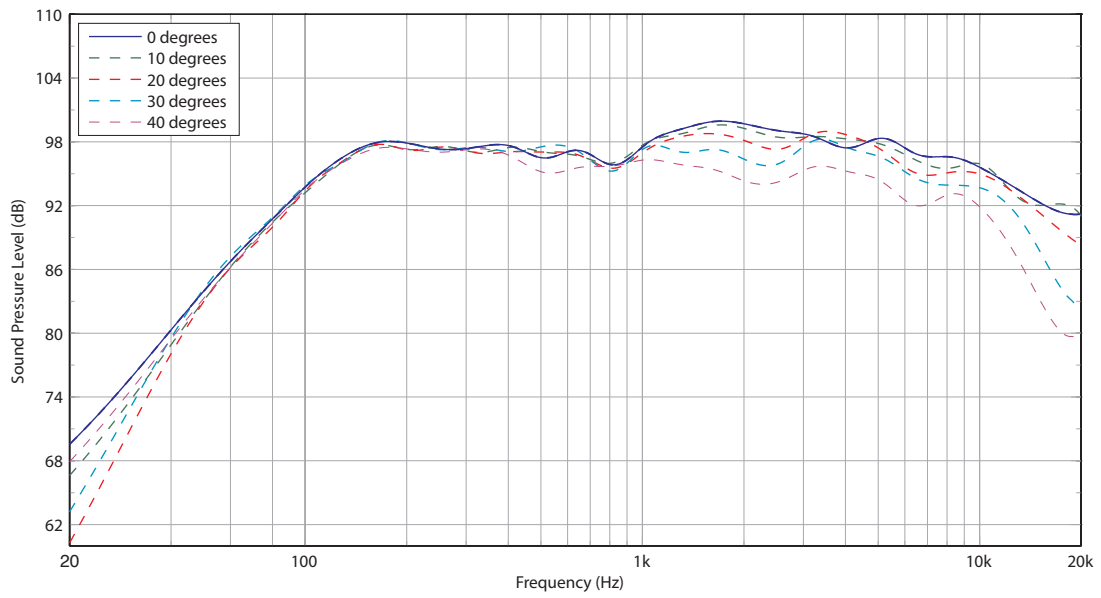

Impedance

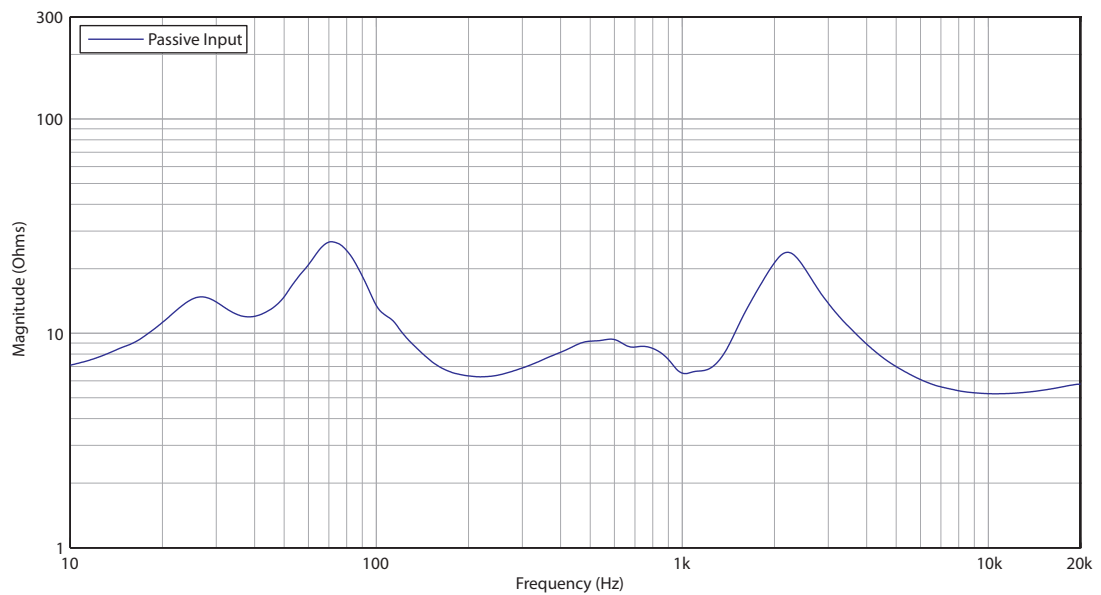

Install Speakers

CMS 1201DCT

12" Full Range Ceiling Loudspeaker with
Dual Concentric Driver and Transformer
for Installation Applications

Horizontal Beamwidth

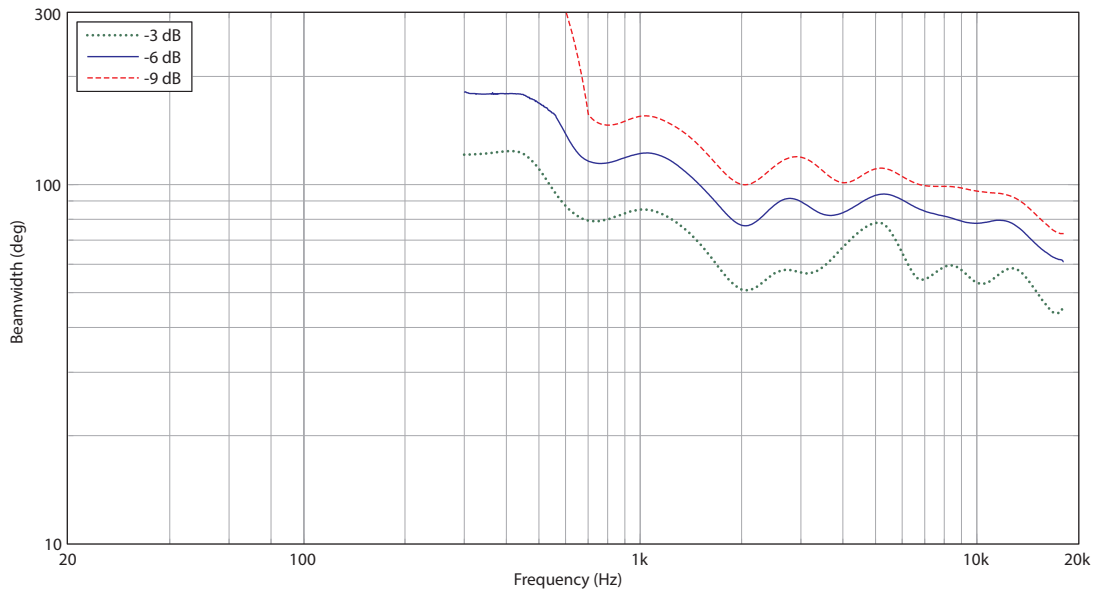

Install Speakers

CMS 1201DCT

12" Full Range Ceiling Loudspeaker with
Dual Concentric Driver and Transformer
for Installation Applications

Horizontal Polar Plots

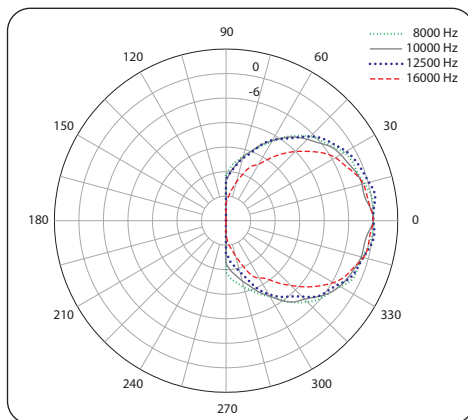
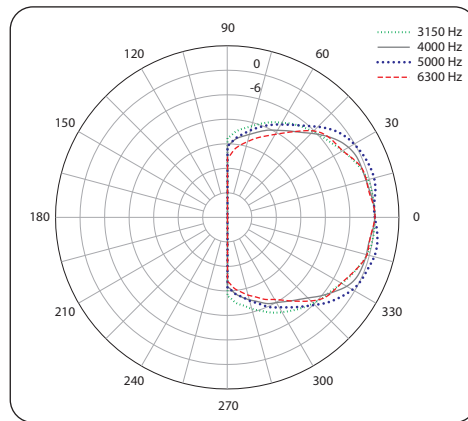
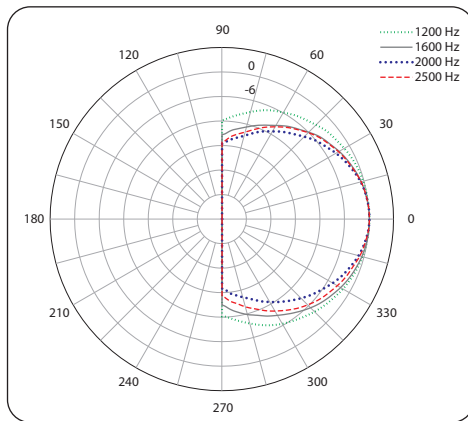
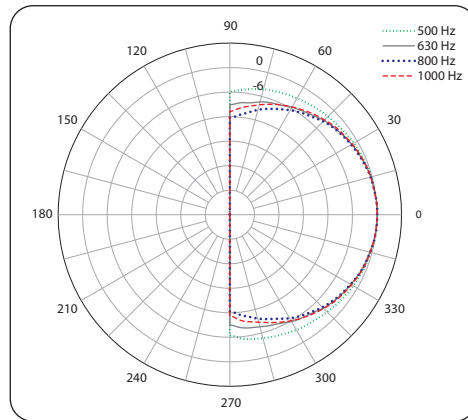
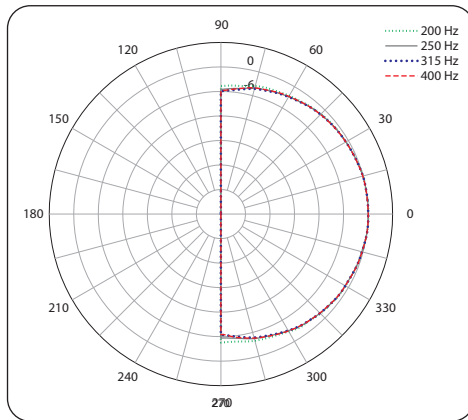

Install Speakers

CMS 1201DCT

12" Full Range Ceiling Loudspeaker with
Dual Concentric Driver and Transformer
for Installation Applications

Dimensions

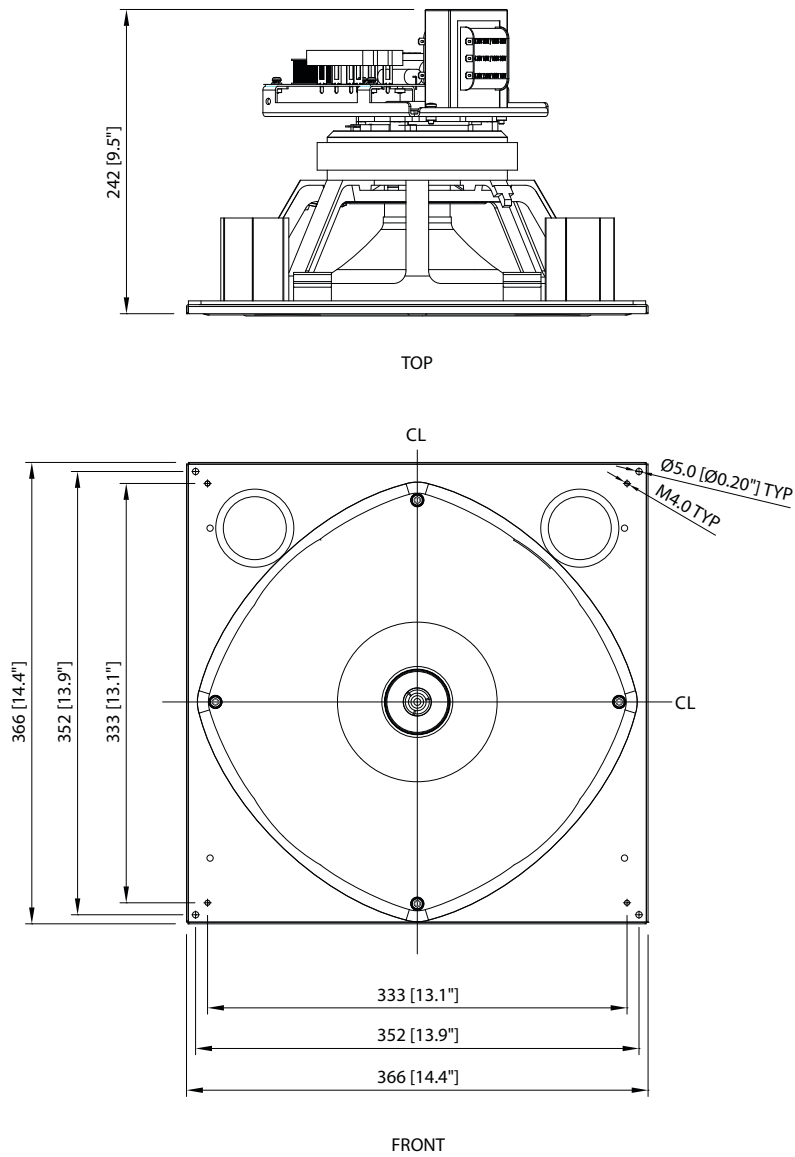

Install Speakers

CMS 1201DCT

12" Full Range Ceiling Loudspeaker with Dual Concentric Driver and Transformer for Installation Applications

Technical Specifications

Performance

Frequency response (-3 dB) ⁽¹⁾	60 Hz - 20 kHz
Frequency range (-10 dB) ⁽¹⁾	45 Hz - 30 kHz
System Sensitivity (1W @ 1m) ⁽²⁾	97 dB (1 W = 2.83 V for 8 Ohms)
Nominal Coverage Angle	90 Degrees Conical
Coverage Angle (1 kHz to 16 kHz)	90 Degrees Conical
Crossover	1.6 kHz - 2nd order LF, 2nd order HF
Directivity Factor (Q)	8.9
Directivity Index (DI)	9.5
Rated maximum SPL⁽²⁾	
Average	120 dB
Peak	126 dB
With THP 60 - Average	115 dB
Power Handling	
Average	200 W
Programme	400 W
Peak	800 W
Recommended Amplifier Power	400 W @ 8 Ohms
Nominal Impedance	8 Ohms
Transformer Taps (CMS 1201DCT only)	
70 V	60 W / 30 W / 15 W / 7.5 W / OFF
100 V	60 W / 30 W / 15 W / OFF

Transducers

Low Frequency	1 x 300 mm (12.00") Dual Concentric™ constant directivity driver with treated cone
High Frequency	34 mm (1.34") aluminium dome with neodymium magnet system

Physical

Enclosure

Backcan	1.6 mm black powder coated steel, damped with 11 mm OSB board
Baffle	1.2 mm black powder coated steel
Grille	1.0 mm white powder coated perforated steel
Connectors	Terminal barrier strip inside the can, with loop thru capability
Safety Features	Safety ring located at the rear of enclosure for load bearing safety bond
Cable Entry Options	20 mm and 28 mm on knockouts
Conduit Knockouts	4 sides + top
Dimensions (H x W x D) including optional backcan	331 x 725 x 516 mm (13.0 x 28.5 x 20.3")
Net Weight	
Backcan	21.4 kg (47.1 lbs)
1201DCT	7.9 kg (17.4 lbs)
Grille	1.0 kg (2.2 lbs)

Notes:

1. Average over stated bandwidth. Measured in an IEC baffle in an Anechoic Chamber
2. Unweighted pink noise input, measured at 1 metre on axis
3. Long term power handling capacity as defined in EIA - 426B test

A full range of measurements, performance data, CLF and Ease™ Data for CMS 1201DCT can be downloaded from tannoypro.com.

Install Speakers

CMS 1201DCT

12" Full Range Ceiling Loudspeaker with
Dual Concentric Driver and Transformer
for Installation Applications

Architecture & Engineering Specifications

The loudspeaker shall be of the ceiling-mounted full range, two-way passive type consisting of one 12" (300 mm) LF driver and one 1.34" (34 mm) HF compression driver. Performance specifications of a typical production unit shall meet or exceed the following: frequency response, measured with swept sine wave input, shall be flat within ± 3 dB from 60 Hz to 20 kHz and within -10 dB from 45 Hz to 30 kHz. Nominal dispersion, at -6 dB points, shall average 90° H x 90° V. Transformer taps: 70V (60W, 30W, 15W, 7.5W, off) and 100V (60W, 30W, 15W, off). Nominal impedance shall be: 8 Ohms. Power handling (8 Ohms) shall be: 400 Watts programme, 800 Watts peak. Sensitivity, measured on axis, mean averaged over stated bandwidth, shall be 97 dB, 1 Watt @ 1 metre. Maximum SPL (peak), measured at 1 metre with music program at stated amplifier input, shall be: 126 dB. Dimensions including optional backcan: 331 mm high x 725 mm wide x 516 mm deep (13.0" x 28.5" x 20.3"). Net weight including baffle, optional backcan, and optional grill: 30.3 kg (66.8 lbs). The loudspeaker system shall be the TANNOY CMS 1201DCT. No other loudspeaker shall be acceptable unless submitted data from an independent test laboratory verifies that the above combined performance / size specifications are equaled or exceeded.

Install Speakers

CMS 1201DCT

12" Full Range Ceiling Loudspeaker with
Dual Concentric Driver and Transformer
for Installation Applications



Install Speakers

CMS 1201DCT

12" Full Range Ceiling Loudspeaker with
Dual Concentric Driver and Transformer
for Installation Applications



Install Speakers

CMS 1201DCT

12" Full Range Ceiling Loudspeaker with
Dual Concentric Driver and Transformer
for Installation Applications

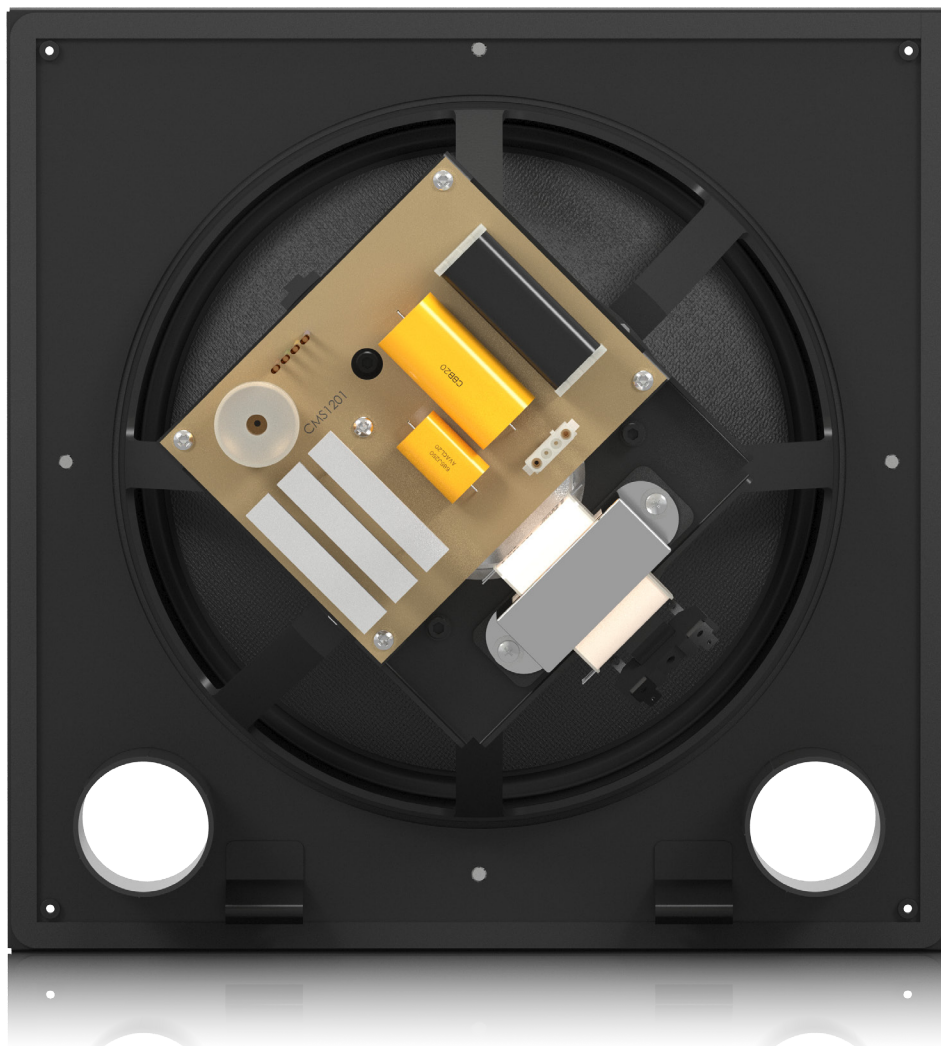

For service, support or more information contact the TANNOY location nearest you:

Europe
MUSIC Tribe Brands UK Ltd.
Tel: +44156 273 2290
Email: CARECrea@music-group.com
CAREEnte@music-group.com
CARELife@music-group.com

USA/Canada
MUSIC Tribe Commercial NV Inc.
Tel: +1 702 800 8290
Email: CARECrea@music-group.com
CAREEnte@music-group.com
CARELife@music-group.com

Japan
MUSIC Tribe Services JP K.K.
Tel: +81 3 6231 0453
Email: CARECrea@music-group.com
CAREEnte@music-group.com
CARELife@music-group.com

MUSIC Tribe accepts no liability for any loss which may be suffered by any person who relies either wholly or in part upon any description, photograph, or statement contained herein. Technical specifications, appearances and other information are subject to change without notice. All trademarks are the property of their respective owners. MIDAS, KLARK TEKNIK, LAB GRUPPEN, LAKE, TANNOY, TURBOSOUND, TC ELECTRONIC, TC HELICON, BEHRINGER, BUGERA and COOLAUDIO are trademarks or registered trademarks of MUSIC Group IP Ltd. © MUSIC Group IP Ltd. 2018 All rights reserved.

TANNOY