

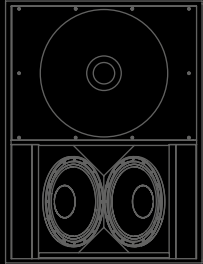

Full Line Catalogue

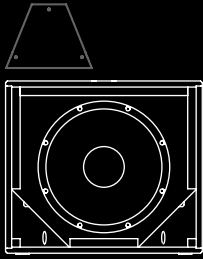

Live / Portable AV

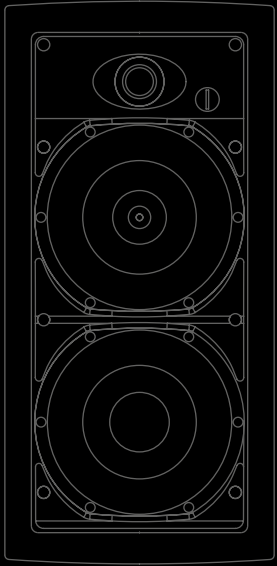
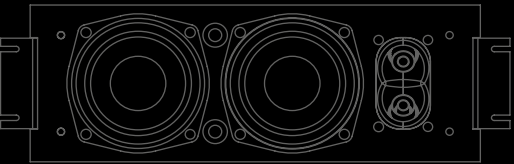
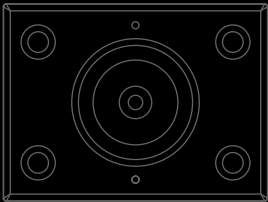
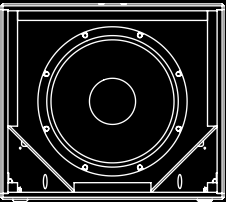

Subwoofers

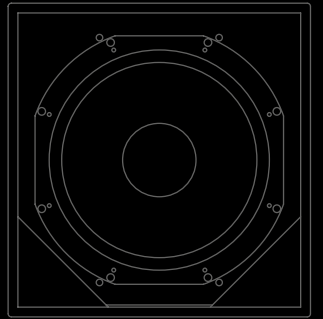
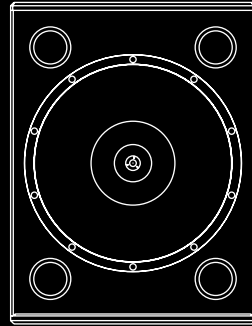
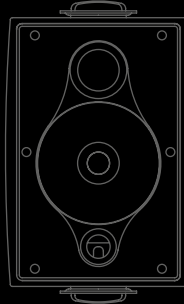
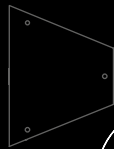
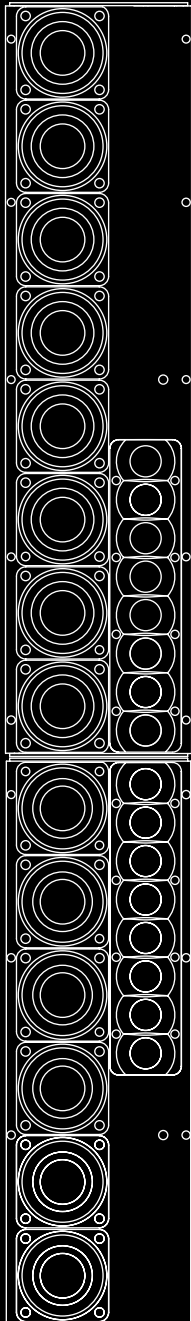
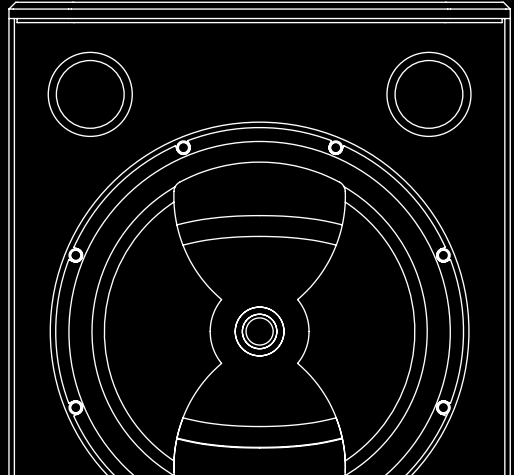

Performance Install

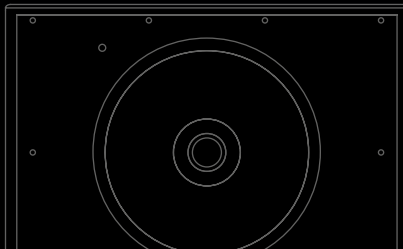
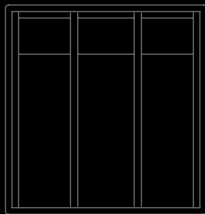
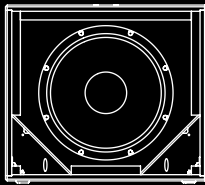

Commercial
Install

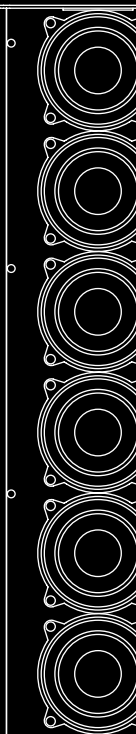
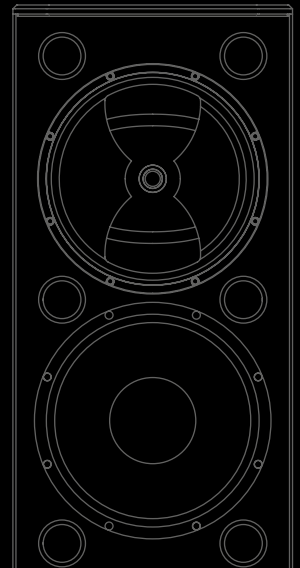

our vision

We create class-leading professional
loudspeaker products of uncompromising
value and performance; harnessing a rich
heritage and tradition of inspired innovation,
bringing tangible benefits to our customers.

Tannoy Professional is dedicated to harnessing the wealth of engineering expertise, market knowledge and long-standing values of the Tannoy brand, bringing it to focus on the commercial install and performance audio sectors. In striving to define the benchmark in the many market segments where the company is active, we seek to provide 'best-in-class' loudspeaker systems that our customers can stake their reputation on.

our Mission

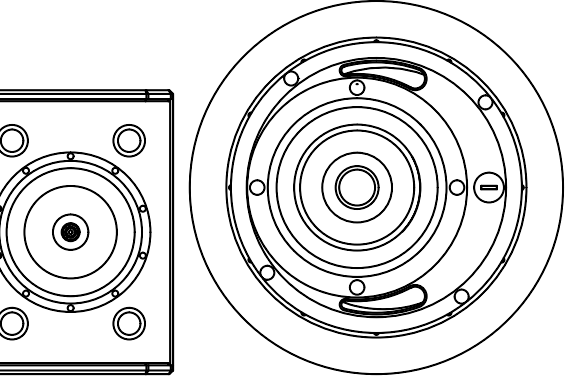

Performance Install

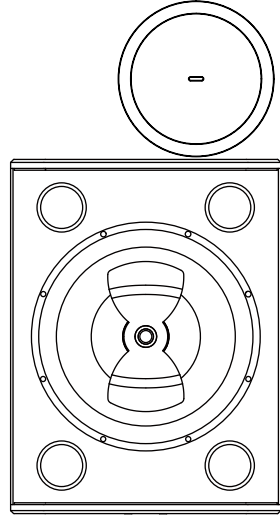
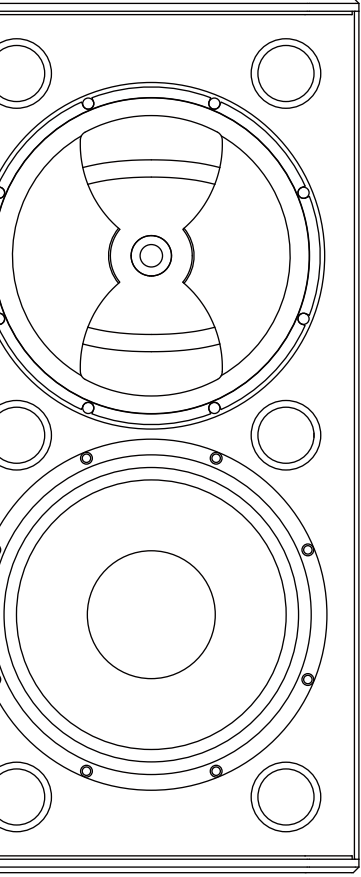

Commercial Install

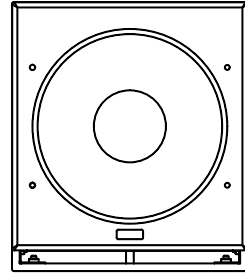
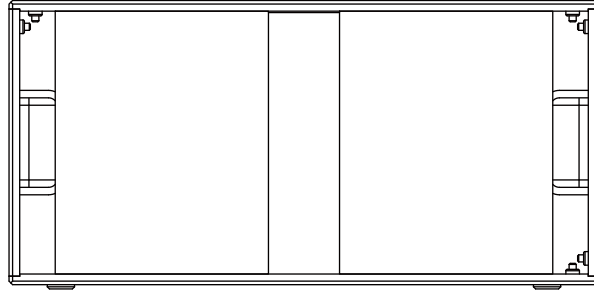
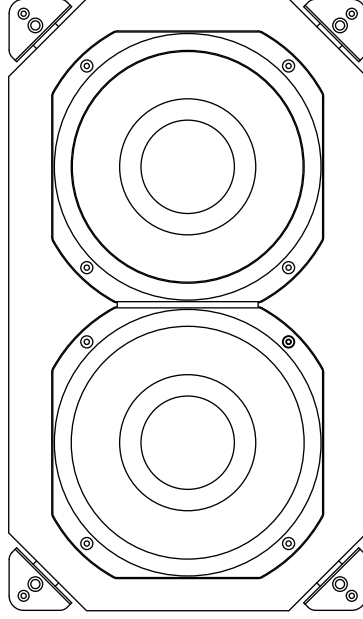

Live / Portable AV

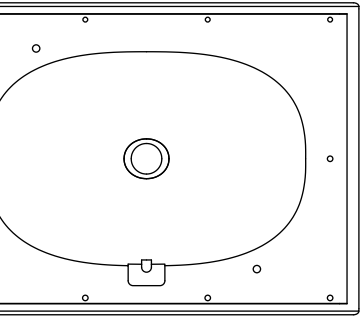

Subwoofers

Contents

Brief history	05
Technology	07

CMS 3.0 Series	15
CMS Series	17
CVS Series	19
OCV Series	21
Di Series	23
DVS Series	25
iW Series	27
VLS Series	29

Commercial Install

13

VX Series	33
VXP Series	35
VQ Series	37
VQNET	41
QFlex	43

Performance Install

31

VQ Live	49
---------	----

Live / Portable AV

47

VSX Series	53
VS Series	55

Subwoofers

51

Professional credentials with a distinguished history

Founded originally as the Tulsemere Manufacturing Company in London, England in 1926, Tannoy presides over a long and distinguished history in the world of audio equipment – as one of the longest continually operating loudspeaker manufacturers still active today. The famous brand name originates from a solid-state rectifier invented by company founder, Guy R. Fountain, made from a Tantalum-Lead Alloy (hence Tannoy), an early indicator of the invention and technical innovation that would become the hallmark of the company throughout the 20th Century and remaining so to this day.



For many, the word 'Tannoy' is synonymous with public address, appearing in the Oxford English Dictionary as: 'a communications system with loudspeakers, used for making announcements in public buildings.' In fact the phrase 'Over the Tannoy' is widely used in the UK and British Commonwealth countries as a colloquial reference to a PA announcement. Few brands in professional audio have had such a prolonged impact in their field, to the extent that it enters the popular mind-set in this way.



1926

Guy R. Fountain founded the Tulsemere manufacturing company in London, UK.



1928

The company changes its name to "Tannoy", derived from the materials used in the manufacture of its Tantalum/Lead Alloy rectifiers for radios.



1946

Tannoy added to the OED after it had become a synonym for "Public Address systems" by servicemen and women during the war (Tannoy supplied most of the PA for Ministry of Defence).



1947

The '15" Dual Concentric is invented by Ronald Reckham and launched at the London Radio Show. The basic principles of the Dual Concentric are maintained still to this day.



1967

Tannoy launches the Monitor Gold Dual Concentric range which go on to be used in famous recording studios across the US and Europe including Abbey Road (EMI) and Decca's studios.



1976

Tannoy relocates production to Coarthridge, Scotland (where it remains to this day).



1979

The Super Red Range of studio monitors launched, cementing Tannoy's peerless reputation in professional recording studio monitoring.

Designed & Manufactured in the United Kingdom

The past 35 years have seen the company base its manufacturing and corporate headquarters in Coatbridge, Scotland where it conceives, designs and manufactures market-leading loudspeaker systems for both professional/commercial install and residential/hi-fi markets. Renowned for its tradition of loudspeaker innovation, most famously for its development and on-going evolution of the Dual Concentric™ point-source transducer and its many derivatives, Tannoy remains at the forefront of the premium performance loudspeaker market, and notably, does so while maintaining its engineering and manufacturing base in the United Kingdom.

This commitment to keeping the brand and its heritage based in the UK is key to the on-going success and market perception of Tannoy loudspeaker products, underpinned by superior performance, uncompromising build quality and that mission to deliver innovative 'best-in-class' products that our customers have come to rely on, over not just years but generations.

Dedicated solutions for the professional audio market

Tannoy Professional – the commercial audio arm of the business – is dedicated to harnessing a wealth of engineering expertise, market knowledge and Tannoy's long-standing brand values and bringing it all to bear on the commercial install and performance audio sectors. Having entered the emerging contractor audio market (as we now know it) in the early 1980's and with a long history before that in the field of live and 'commercial' PA systems dating back to the 1940's Tannoy Professional today holds true to a core ethos in striving to define the benchmark in the many segments of commercial loudspeaker design where the company is active. Among these, Tannoy has become a recognised leader in premium performance commercial install audio as well as being a key player in the small and medium-scale sound reinforcement loudspeaker markets, with many highly successful product lines to be found in bars, clubs, hotels, music venues, malls, houses of worship, theatres and theme parks the world over.

Still at the forefront of loudspeaker innovation

Since becoming part of the TC Group of companies in 2002, with sister company Lab.gruppen – itself a respected innovator in professional audio with its market leading power amplifier and loudspeaker management products – Tannoy Professional has benefitted from access to a wealth of engineering expertise, developing cutting-edge products with the aim of taking the Tannoy brand quality to a wider range of potential applications in the commercial install and performance audio sectors. These most recent product developments have heralded a new period of growth and expansion, and reinforced the Tannoy ethos of leveraging technical innovation to provide the market with peerless products that deliver unique real-world performance benefits and highly competitive value.

The success of these new products, and continuing focus on innovation and improvement, ensures that Tannoy Professional is well placed to remain a leading name in commercial install and performance audio for years to come.



The evolution of technology

Dual Concentric driver technology

Tannoy is perhaps most renowned for developing the first true point-source transducer – the Dual Concentric driver. First developed in 1948, the technology has been subject to constant evolution and refinement over successive decades, taking advantage of new materials, manufacturing methods and acoustic research. The latest iteration of this technology is found in Tannoy's leading products across a wide range of commercial install and sound reinforcement applications, including premium in-ceiling, in-wall and surface mount systems. Unlike ordinary drive units, the Dual Concentric is effectively two drivers properly merged into one. The high-frequency unit is positioned on the back of the low frequency driver so that they are effectively on the same axis.

With this system the sound energy is propagated from the same point and delivered through the centre of the low frequency cone – a true point-source. The Dual Concentric delivers a spherical wave front that ensures even dispersion in the horizontal and vertical planes, providing exceptional off-axis performance.

Discrete loudspeakers have an inherent design flaw in that each drive unit is an acoustic source of its own. While the components are physically aligned on the vertical axis they cannot remain so except for at one listening point. Even those discrete systems with rotating horns suffer from a significant 'suck-out' in the crossover region and no amount of DSP processing can correct this phenomenon. The constant directivity characteristic of the Dual Concentric overcomes such time alignment problems.

Dual Concentric explained

Discrete driver speaker systems cannot reproduce signals accurately because their sources are displaced in space.

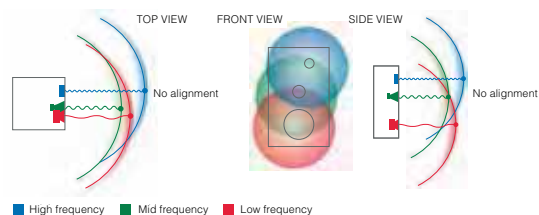

Even when delays are applied to compensate for driver alignment, signals can only be aligned along a narrow listening plane on one axis.

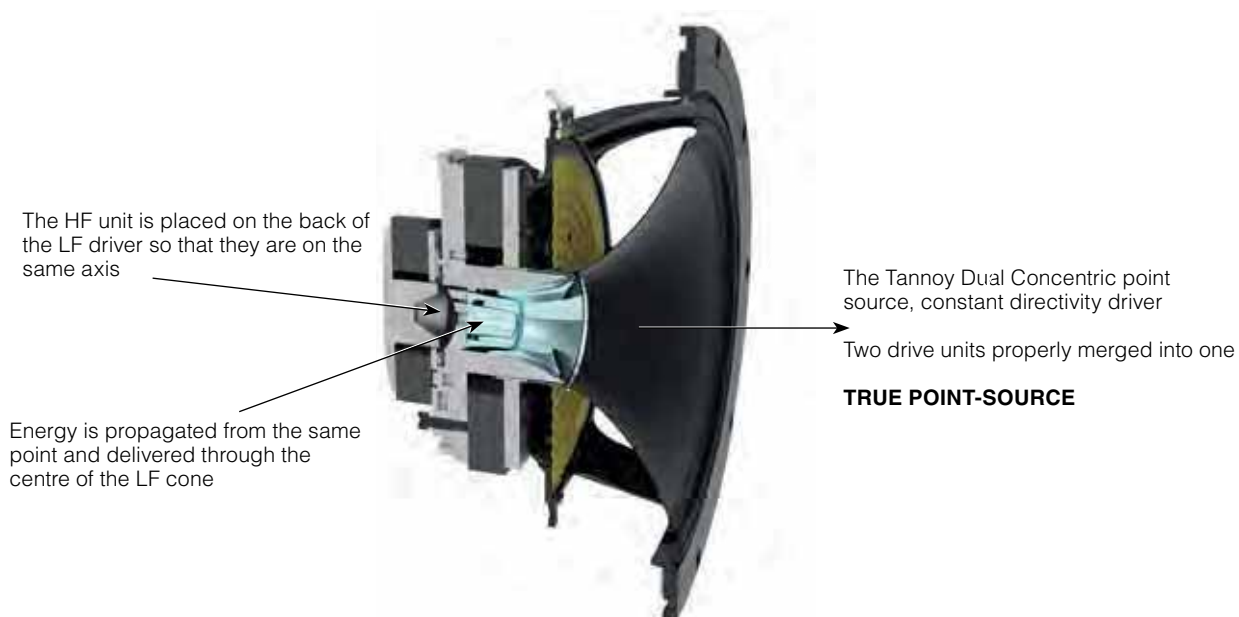
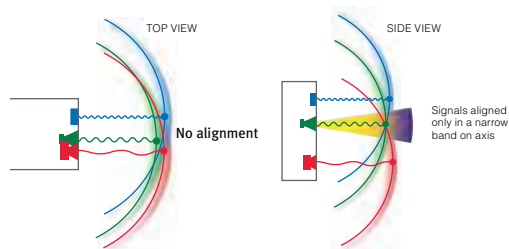

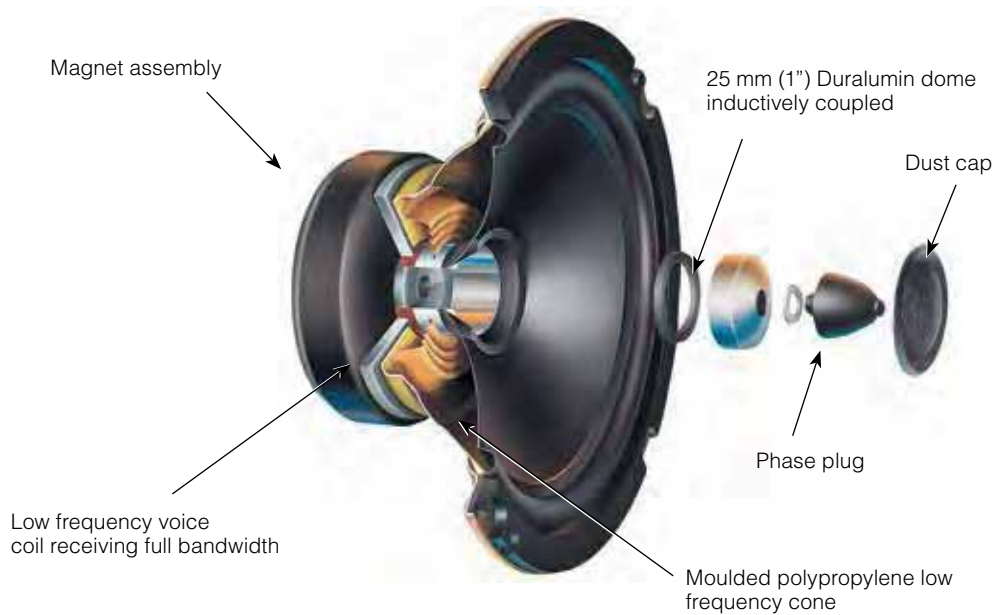

ICT™ driver technology

The point-source configuration of the Tannoy ICT driver's mid-bass and tweeter sections ensures a wide and controlled dispersion for optimum coverage. By utilising a wireless electromagnetic tweeter that does not require a crossover and cannot be burned out from heavy or abusive use, this drive unit addresses the two most common component failures experienced in background music and sound reinforcement systems - the tweeter and the crossover.

The use of an inductively coupled 25 mm (1") Duralumin domed wireless electromagnetic tweeter means that no crossover is required in the design. The high frequency dome has a deep drawn skirt which sits on the inside of the low frequency voice coil in the same magnetic gap. Like a single shorted turn, it is induced with high frequency information generated by the low frequency voice coil, which is fed a full bandwidth.

FAST™: Innovative passive crossover design

The VLS Series passive column system introduces another first for Tannoy in the form of Focused Asymmetrical Shaping Technology™ (FAST). An innovative new passive crossover network design, coupled with transducer technology adapted from QFlex, gives VLS Series loudspeaker products unique acoustic performance benefits not previously seen in a passive product of this type. Central to this is its asymmetrical vertical dispersion, gently shaping the acoustic coverage towards the lower quadrant of the vertical axis. By the nature of a typical application, an ideal column loudspeaker should be biased in the vertical plane, towards the audience and away from reflective surfaces above (like ceilings) which are detrimental to intelligibility. As well as this 'passive fixed steering', FAST also facilitates quicker, easier installation with less need for tilting or specific concern for optimal mounting.



The Revolution, evolved

The Omnimagnet Dual Concentric

The parameters available to achieve a high level of audio performance are dictated by established acoustic design principles. Any improvement to an already impeccable driver design is therefore a tough challenge. Utilising the latest electro-acoustic research and tools, this was the task for Tannoy's team of highly experienced engineers whilst developing a new drive unit.

The Omnimagnet Dual Concentric is a completely new interpretation of Tannoy's proprietary point source drive unit philosophy; a major milestone in more than 65 years of the company's audio research and development. A revolutionary new HF diaphragm and waveguide have been combined with a single magnet to deliver notable performance advantages.

Providing wider high frequency directivity, the HF diaphragm and the precision engineered Torus Ogive Waveguide™ have been brought further forward. Based on innovative new patent pending design principles, the shallower waveguide improves LF performance, giving more headroom and enabling a higher crossover point. Essential to achieving the desired directivity improvements, the wave-front expands a faster rate, delivering articulate and precise reproduction, both on and off-axis, through closer acoustic-centre alignment and phase coherence.

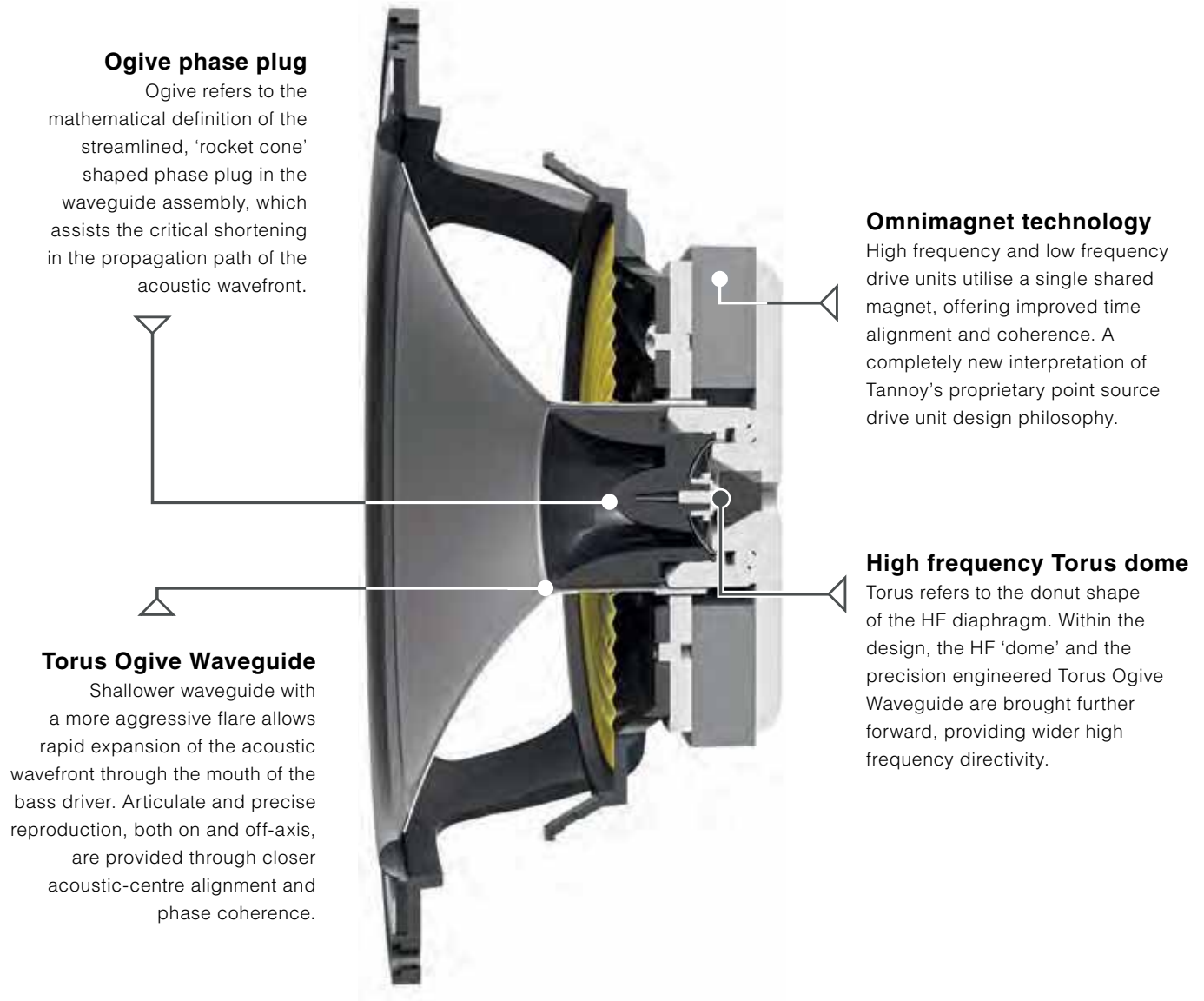

VQ Series: High performance point-source technology

Cutting edge point-source driver

VQ Series is our large format performance audio loudspeaker system designed for high SPL, large scale installed applications such as sports arenas and large Houses of Worship. In realising these products, we developed unique driver technology, designed to radiate a coherent single point-source for superior dispersion control when coupled to our proprietary horn system. This advanced design aligns the acoustical centres of the transducers providing a single coherent wave-front emanating from the throat. The driver uses two concentric annular ring diaphragms, coupled to a uniquely engineered Point-Source Waveguide™. The larger of the two diaphragms has a 3.5" voice coil and reproduces frequencies from 400 Hz to 7 kHz – the major advantage here being that there is no crossover anywhere near the vocal region, thus ensuring natural and phase-coherent reproduction at this critical area. The 2" HF diaphragm takes over at 7 kHz to 22 kHz by way of a passive or an active crossover. The external casting features extensive heat-sinking ensuring good heat transfer for high power handling and very low power compression.

Horn design without compromise

The use of what is essentially a Dual Concentric compression driver results in a wave-front at the throat of the horn being perfectly coherent across its frequency range. The MF/HF transducer loads into a large, proprietary design common horn. There is a huge advantage here in comparison to acoustic sources hitherto used with horns which consist of an HF compression driver and a separate midrange compression driver, each with its own horn. Invariably there is interference between the midrange and high frequency at the crossover. This results in uneven off axis performance, even if the HF horn is mounted in front of the MF horn. This artefact is compounded even further if the sources are displaced on the front baffle.

For more information on VQ Series, see page 37

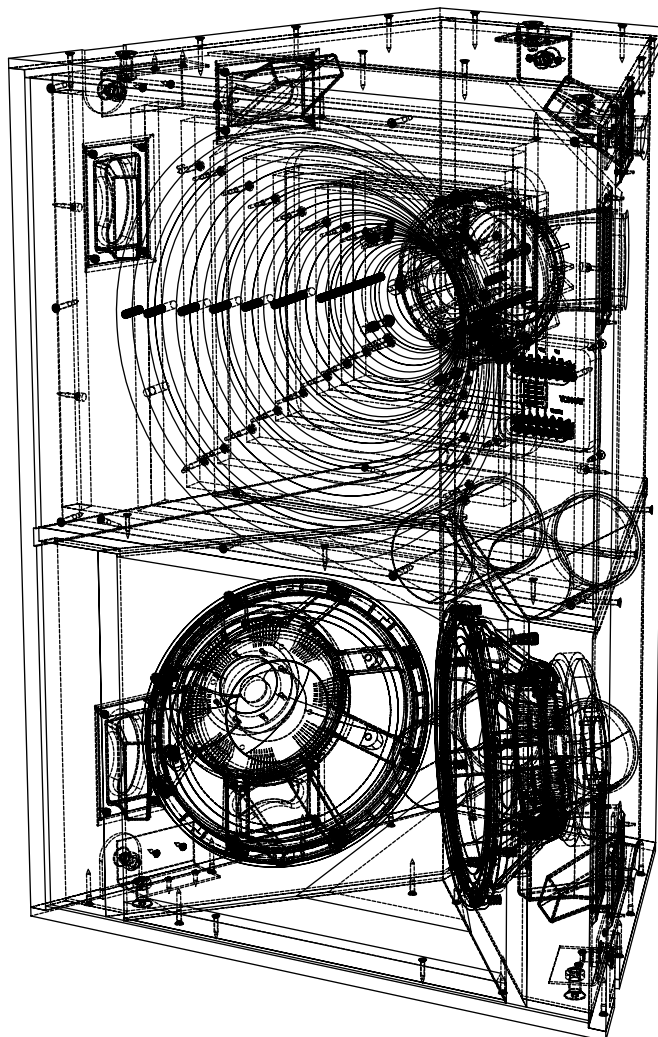

VNET™ Self-powered, networked DSP platform

The VNET is our proprietary loudspeaker networked DSP platform, comprising of both software and hardware DSP components. The VNET packaging combines integrated Class D amplification with on-board DSP - all fully networkable - allowing for remote system commissioning, optimisation and real-time diagnostics of an installed sound system, via standard Ethernet network. The VNET software suite is available to download from tannoypro.com and runs on any Windows PC or Tablet.



QFlex: Best-in-class digital beam steering technology

The key to the class-leading performance of our award-winning QFlex beam-steering loudspeakers lies in a perfect combination of the unique driver assembly design, cutting-edge onboard DSP and revolutionary software steering algorithms. To achieve the desired level of acoustic control, it's crucial that the low frequency driver elements are densely spaced like the high frequency drivers for effective operation over their pass-band. The 3" and 4" low frequency drivers in QFlex have been optimized with a combination of FEA (Finite Element Analysis), Klippel™ Analysis, and laser interferometry. With a highly efficient neodymium magnet structure and under-hung voice coil, we are able to achieve large linear excursions while maintaining distortion free performance. This affords us the desired low frequency performance while maintaining our dense spacing.

We also developed a very unique high frequency array solution, resulting in an 8 element array with a specially designed neodymium magnet structure allowing for very dense spacing of the sources. The critical factor in maintaining a coherent, focused beam and minimising grating lobes, even at higher frequencies, is in the spacing of the HF sources. The closer they are, the wider the effective bandwidth control can be. The dome centres in QFlex are only 30 mm apart, banishing aliasing (lobing) to frequencies beyond 12 kHz – no other competing design can achieve this level of performance. Thermal power handling is further augmented by the inclusion of a common heat sink on the rear of the high frequency array.

For more information on QFlex, see page 43

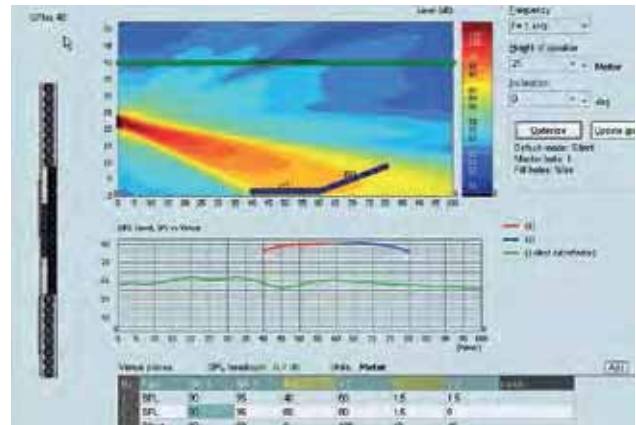

British built: refined fabrication

Tannoy continues a proud tradition of UK-based manufacturing, with the majority of our leading professional loudspeaker products built in the factory at Coatbridge in Scotland. All of our wooden enclosure sound reinforcement ranges, including VX Series, VSX Series and VQ Series, are built to exacting standards – with enclosure, driver and electronics assembly and rigorous testing and quality assurance all taking place within the modern manufacturing facility. Loudspeaker enclosures are fabricated in the expansive onsite wood shop using the latest techniques and technology in CNC (Computer Numerical Control) routing for precise engineering and high quality finishing. Our skilled craftsmen are trained to the highest standard, many of whom have been making Tannoy loudspeakers for over 30 years, since the factory relocated from London to its current site in the mid 1970's.

This long-standing local manufacturing tradition allows Tannoy to maintain tight control on quality standards, ensuring that our products perform to the highest levels consistently and reliably – giving our customers complete peace of mind. It also gives us the flexibility and manufacturing agility to respond to very specific customer needs, tailoring solutions to a particular application requirement, something that sets us apart from many of our competitors.



Commercial Install

The Tannoy brand can be found in a myriad of loudspeaker applications and markets but perhaps nowhere is the strength of the brand more respected and firmly established than in the commercial install sector. Whether its conventional ABS enclosure surface mount devices or discrete in-ceiling or in-wall systems, Tannoy offers a broad spectrum of products catering for all manner of performance demands and cost considerations. All share a common design philosophy: delivering best-in-class sonic performance in an aesthetically honed, easy-to-install device - and providing long-term reliability to ensure contractor peace of mind and end-user satisfaction.



When it comes to premium sonic performance, Tannoy employs the latest evolution of its renowned proprietary Dual Concentric point-source transducer technology in a wide range of Commercial Install products. Most popular among these are the well-established CMS Series of in-ceiling loudspeakers and the stylish surface-mount Di Series, both found in almost every commercial install application imaginable. As well as point-source devices, Tannoy is also a leader in passive column array loudspeakers, exemplified by VLS Series - featuring our proprietary Focused Asymmetrical Shaping Technology (FAST).

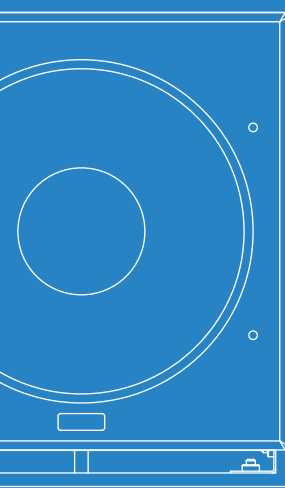

In addition to premium-grade products, Tannoy also provides a range of compelling product lines where optimal value is a driving concern, without typical compromise on performance and reliability. The unheralded success of CVS Series over the past few years, and more recently DVS and OCV Series, is testament to the fact that Tannoy delivers products that perfectly meet the requirements of the market - both at the high end and mid-level of customer demand and project budget.

series

CMS 3.0 – The Revolution Reinvented

Introducing CMS 3.0... The 3rd generation of Tannoy's premium in-ceiling loudspeaker system, featuring a new evolutionary milestone development of our Dual Concentric™ transducer technology.

Bringing even higher degrees of intelligibility, more consistent broadband directivity, and a brighter, more accurate soundstage; CMS 3.0 represents a new pinnacle in sonic performance from a ceiling loudspeaker device. In addition to improved sound and smooth predictable coverage, the all-new CMS 3.0 also introduces several mechanical and aesthetic features to benefit both systems designer and contractor alike. The new line of Dual Concentric equipped CMS comprises 5 models – CMS 403DCe, CMS 503DC, CMS 603DC and

CMS 803DC – each designed to replace previous equivalent iterations – plus an all-new CMS 803DCQ 8" high-Q model, designed for high-ceiling/longer throw applications. At the heart of each device is the next-generation Dual Concentric™ transducer, providing improved performance by virtue of a fundamentally new design.

In addition to new driver technology, CMS 3.0 also benefits from new magnetically adhering grilles, easy to fit or remove (for hassle-free custom painting) and available in either Classic (traditional, inset within the bezel) or new Arco™ style – designed to conceal the entire unit including the bezel beneath a sleek architectural grille, for applications where mitigating any aesthetic impact is a driving factor.

Features

- Advanced new Dual Concentric driver design utilizing Omnimagnet technology
- Newly refined 165 mm (6.5") ICT transducer for greater durability and longevity
- Torus Ogive Waveguide device for improved broadband directivity
- Improved time alignment and phase coherence, delivering even better sonic performance
- High power and high sensitivity with extended frequency response and very low distortion
- Improved LF performance for applications where genuine bottom-end is a must
- Convenient front-tapping switch for settings

Applications

- Auditoria / Lecture Theatres
- Ballrooms and convention Centres
- Bars & Restaurants
- Casinos
- Concourses
- Conference rooms
- Fitness Centres & Leisure Facilities
- Hotels
- Museums & Galleries
- Retail Spaces & Malls

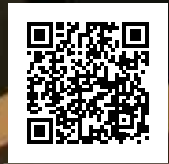

SCAN FOR
PRODUCT DATA



CMS 3.0 SERIES AT A GLANCE

Model	Dispersion	Frequency Range (-10dB)	Sensitivity	Rated SPL (avg.)	Rated power	Dimensions (Dia x Depth)
CMS 403DCe	-	80 Hz - 54 kHz	88 dB	107 dB	120 W @ 16 ohms	205 x 147.6 mm
CMS 403ICTe	-	80 Hz - 24 kHz	88 dB	107 dB	120 W @ 16 ohms	205 x 147.6 mm
CMS 503DC	-	74 Hz - 54 kHz	89 dB	107 dB	120 W @ 16 ohms	205.9 x 188 mm
CMS 503DC LP*	-	77 Hz - 54 kHz	89 dB	107 dB	120 W @ 16 ohms	274 mm x 98.6 mm
CMS 503ICT LP*	-	77Hz - 54kHz	89 dB	106 dB	100 W @ 16 Ohms	274 mm x 98.6 mm
CMS 503ICT	-	74 Hz - 24 kHz	89 dB	107 dB	120 W @ 16 ohms	205.9 x 188.5 mm
CMS 603DC	-	50 Hz - 30 kHz	91 dB	110 dB	160 W @ 16 ohms	274 x 255.8 mm
CMS 603ICT	-	74 Hz - 24 kHz	91 dB	110 dB	160 W @ 16 ohms	274 x 256.8 mm
CMS 803DC	-	40 Hz - 35kHz	92 dB	112 dB	180 W @ 16 Ohms	319 x 310.5 mm
CMS 803DCQ	-	40 Hz - 35kHz	93 dB	113 dB	180 W @ 16 Ohms	319 x 310.5 mm

*LP models available Spring 2015

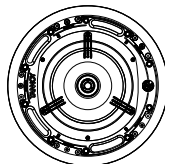
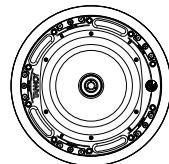
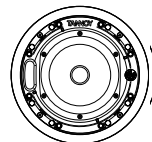
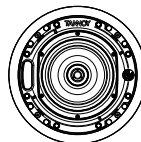
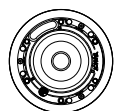
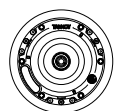
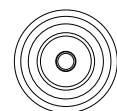
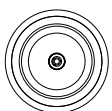

CMS 403DCe

CMS 403ICTe

CMS 503DC

CMS 503DC LP

CMS 503ICT LP

CMS 503ICT

CMS 603DC

CMS 603ICT

CMS 803DC

CMS 803DCQ

Lorem ipsum, AMIET



SCAN FOR
PRODUCT DATA



Uncompromising in-ceiling performance

The CMS 1201DC is the latest addition to Tannoy's large format in-ceiling loudspeaker range, designed and built to complement the existing class-leading CMS range. From the pioneers of point source and large format ceiling speakers the CMS 1201DC is engineered from the ground up with superior full-range performance in mind to handle demanding distributed sound applications such as ballrooms, shopping malls, sports halls, airports and other high ceiling installations.

Built around a brand new evolution of the high power handling 12" (300mm) Dual Concentric™ point source driver, the CMS 1201DC delivers best-in-class performance for the most even beamwidth and pattern control over the widest range of frequencies of any large format ceiling speaker. Coupled with exceptional clarity, ultra low distortion, and high SPLs, CMS 1201DC raises the bar to give the absolute cutting edge performance in ceiling mounted loudspeaker technology.

Achieving new standards of full bandwidth coverage control means that the CMS 1201 can be specified in distributed designs with absolute confidence and located as efficiently as possible, minimising the number of devices typically required to cover a given area, reducing install time and

cost. All Tannoy ceiling loudspeakers are simple to design into a wide variety of applications using our Ease Address™ design software.

Each device comprises of 3 discrete components: the loudspeaker assembly (mounted on ported steel baffle), a separate 79 litre (2.8 cubic feet) steel back-can with multiple mounting points and a white powder-coated steel grille and moulded bevel cover.

The CMS 1201 is available in both a standard low-impedance variant (CMS 1201DC) and a low insertion loss 60 W line transformer-equipped version (CMS 1201DCT) for use on 70 V or 100 V distributed lines

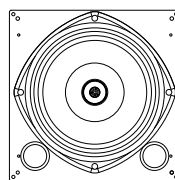

CMS 1201DC

Features

- 12" (305mm) point source Dual Concentric™ driver with Ferrofluid cooled Neodymium HF
- High power & high sensitivity with extended LF response and very low distortion
- Highly controlled full-bandwidth 90 degree dispersion
- High power handling (400W rec. power), high SPL (120dB sustained average)
- Highly versatile back-can installation options
- 79 litre Back-can lined with OSB2 board for optimum acoustic performance
- Designed to meet UL-1480 and UL-2043 Listing specification
- One-man install thanks to quick-fix baffle fitment
- Available with optional low insertion loss 60 W line transformer
- 5-year warranty

Applications

- Ballrooms and convention Centres
- Bars & Restaurants
- Casinos
- Conference rooms
- Corporate AV
- Fitness Centres & Leisure Facilities
- Hotels
- Museums & Galleries
- Retail Spaces & Malls
- Transport Hubs

CMS SERIES AT A GLANCE

Model	Dispersion.	Frequency Range (-10dB)	Sensitivity	Rated SPL (avg.)	Rated power	Dimensions
CMS 1201DC	90°	45 Hz – 30 kHz	99 dB	122 dB	400 W @ 8 ohms	331 x 725 x 516 mm



Performance and value, in perfect balance

The CVS Series of in-ceiling loudspeakers was conceived to meet increased market demand for the best possible performance / price balance, combining Tannoy's renowned point-source sonic characteristics with highly competitive affordability. They have become one of the most successful commercial install product lines, satisfying the demand to maintain a high standard of acoustic performance while keeping project costs under tight control.

All CVS devices utilise the same proprietary Tannoy co-axial transducer technology found in the DVS surface-mount and OCV pendant products, engineered to deliver a level of sonic performance unmatched by comparably priced products on the market and allowing systems designers to retain the

benefits of Tannoy's long history and expertise in loudspeaker products, even in value-engineered project situations.

There are 4 models in the range, featuring 4", 6" and 8" transducers respectively, with an ultra-compact shallow back can variant of the 4" model available. CVS products are self-contained, coming complete with integral zinc-plated steel back can and integrated low-insertion loss transformer (with configurable tapings via front-baffle-mounted rotary switch) for use in distributed audio systems. All models are packaged with C-ring and tile-bridge and fully supported with industry standard certifications, including UL-1480, UL-2043 and CE, making them particularly well suited for demanding public sector and transport network applications.

Features

- Reliable co-axial transducers providing accurate point-source performance
- High power and high sensitivity with extended frequency response and very low distortion
- Wide, controlled constant directivity dispersion for optimum coverage
- Ferrofluid cooled neodymium HF
- UV / weather resistant UL94V-0 ABS paintable front baffle
- UL Listed (1480, 2043)
- EN54 compliant models available
- Integral low insertion loss line transformer

Applications

- Auditoria & lecture theatres
- Ballrooms & convention centres
- Bars & restaurants
- Casinos
- Concourses
- Conference rooms
- Fitness centres & leisure facilities
- Hotels
- Museums & galleries
- Retail spaces & malls



SCAN FOR
PRODUCT DATA



CVS SERIES AT A GLANCE

Model	Dispersion	Frequency Range (-10 dB)	Sensitivity	Rated SPL (avg.)	Rated power (@ 6 ohms)	Dimensions (Dia x Depth)
CVS 4	102°	77 Hz - 22 kHz	87 dB	103 dB	80 W	213 x 202.5 mm
CVS 4 Micro	102°	90 Hz - 22 kHz	87 dB	103 dB	80 W	213 x 98.3 mm
CVS 6	93°	60 Hz - 24 kHz	91 dB	109 dB	120 W	279.5 x 246.5 mm
CVS 8	90°	60 Hz - 24 Hz	93 dB	120 W	355.6 x 251 mm	

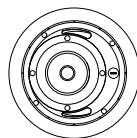

CVS 4

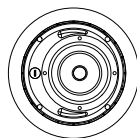

CVS 4 Micro

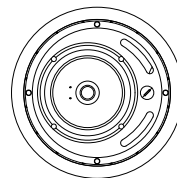

CVS 6

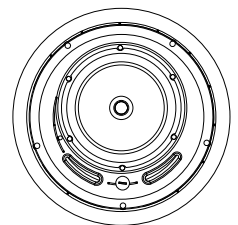

CVS 8

Raddison Blu Hotel, Bergen - NORWAY



SCAN FOR
PRODUCT DATA



Bringing quality sound to new heights

Comprising of 2 models, Tannoy's OCV Series is a hanging pendant loudspeaker system designed to deliver the impressive acoustic performance and exceptional value of the ubiquitous CVS Series in-ceiling products but in an architecturally sensitive, self-contained, lightweight cylindrical enclosure. Engineered specifically for applications where predictable high quality audio coverage is required in high- or open-ceilinged spaces – such as airports, railway stations, malls or double- or triple-height commercial floors – without compromising clarity, coverage control and SPL.

The unique cylindrical form-factor evolved after consultation with the architectural sector, meeting a desire to minimise the impact on aesthetics and allowing the systems designer to locate the loudspeakers discretely at any desired position. Unlike in-ceiling devices, OCV can be positioned without regard to a ceiling cavity or specific ceiling height, and in a manner that won't conflict with other suspended systems such as lighting fixtures and ventilation. OCV Series was also developed to meet an increasingly critical demand from

installation professionals for a self-contained suspended loudspeaker system that delivers a competitive performance advantage without being compromised by excessive cost. OCV Series presents an unrivalled value proposition to the market in that respect.

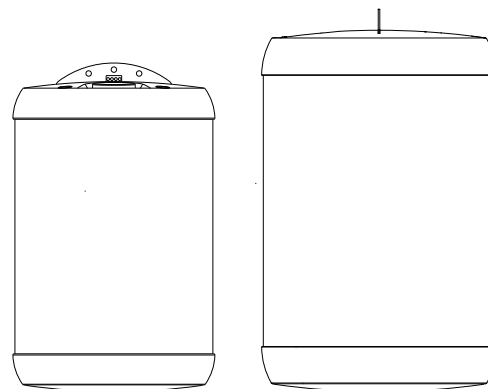

OCV 6

OCV 8

Features

- 2 models available - 6" and 8" driver complements
- Architecturally-led aesthetic
- IP55 Rated and UV / high temp tested
- Available in White and Black; custom colours optional
- Quick and easy hanging system for minimal installation time
- Gripple® brand cable fastener allows up to a 9 foot hang with included kit
- 3 / 8" all-thread rod adaptor for attaching to Unistrut

Applications

- Ballrooms & convention centres
- Concourses
- Fitness centres & leisure facilities
- Museums & galleries
- Retail spaces & malls
- Transport hubs
- Corporate AV
- Conference rooms

OCV SERIES AT A GLANCE

Model	Dispersion	Frequency Range (-10 dB)	Sensitivity	Rated SPL (avg.)	Rated power (@ 16 ohms)	Dimensions (overall length x circumference)
OCV 6	90°	60 Hz – 30 kHz	88 dB	105 dB	120 W	423 mm x 260 mm
OCV 8	80°	50 Hz – 30 kHz	90 dB	108 dB	140 W	492.5 mm x 302 mm

Yas Marina hotel, Yas Marina F1 Circuit - ABU DHABI



Peerless performer with designer aesthetics

Tannoy Di (Designer Install) Series is a range of compact, weather-resistant surface-mount loudspeakers designed for applications where aesthetic appeal, durability and sonic performance are all pertinent issues.

The range comprises of 5", 6" and 8" driver equipped devices, utilising both ICT and Dual Concentric transducers depending on specific model, all enclosed within a scuff-resistant high impact polystyrene enclosure (HIPS) which is fully optimised for consistent performance in both indoor and outdoor conditions. The passive models benefit from being IP64 rated - making them perfectly suited for installation in most outdoor areas.

Di Series products are available in black or white as standard, and come equipped with steel mounting bracket. Two optional mounting accessories are available: a pole mount adaptor kit and, specifically designed for the passive Di models, the unique, pre-wired and fully adjustable wall bracket, the K-Ball™.

Since its introduction, Di Series has proven itself as a highly effective surface-mount loudspeaker solution in a host of applications, both indoor and out, where stylish looks and musical performance are required. Ideal for bars, restaurants and hotel resorts with outdoor areas, as well as retail spaces and theme parks where higher performance background music is desired.

Features

- Dual Concentric and ICT transducer variants for high performance and durability.
- 90 degree controlled conical dispersion for optimum coverage and forward gain
- Weather resistant rated IP64 (passive models)
- Phase coherent design for superior vocal articulation and music reproduction
- Yoke bracket supplied, optional accessories include pole mount adaptor and the unique K-Ball pre-wired, fully adjustable multi-angle bracket
- High power handling and extended bandwidth

Applications

- Bars & restaurants
- Conference rooms
- Corporate AV
- Fitness centres & leisure facilities
- Hotels
- Museums & galleries
- Retail spaces & malls
- Theme parks & visitor attractions
- Concourses
- Ballrooms & convention centres



SCAN FOR
PRODUCT DATA



DI SERIES AT A GLANCE

Model	Dispersion	Frequency Range (-10 dB)	Sensitivity	Rated SPL (avg.)	Rated power	Dimensions (H x W x D)
Di 5 / Di 5t	90°	80 Hz - 30 kHz	88 dB	105 dB	100 W @ 6 ohms	241 x 155 x 162 mm
Di 5a	90°	90 Hz - 30 kHz	88 dB	103 dB	30 W RMS	241 x 155 x 162 mm
Di 5DC / Di 5DCt	90°	80 Hz - 54 kHz	88 dB	106 dB	120 W @ 8 ohms	241 x 155 x 162 mm
Di 6 / Di 6t	90°	55 Hz - 24 kHz	90 dB	107 dB	120 W @ 6 ohms	358 x 230 x 224 mm
Di 6DC / Di 6DCt	90°	55 Hz - 35 kHz	89 dB	109 dB	180 W @ 8 ohms	358 x 230 x 224 mm
Di 8DC / Di 8DCt	90°	53 Hz - 35 kHz	91 dB	111 dB	180 W @ 8 ohms	405 x 260 x 261 mm

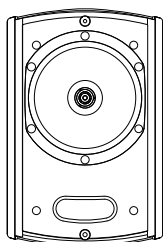

Di 5 / Di 5t

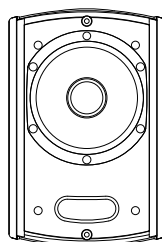

Di 5a

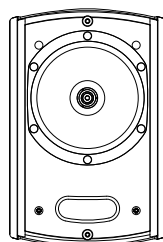

Di 5DC / Di 5DCt

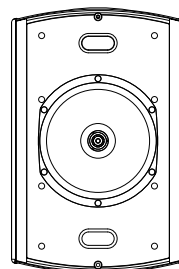

Di 6 / Di 6t

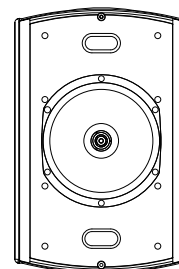

Di 6DC / Di 6DCt

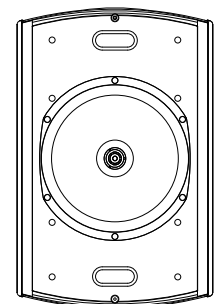

Di 8DC / Di 8DCt



High quality. Exceptional value.

Designed for a wide variety of discrete small-to-medium scale sound reinforcement applications, DVS Series is an compact surface-mount loudspeaker of exceptional value and acoustic performance, with a stylish aesthetic to boot. These full-bandwidth loudspeaker devices are proven performers in commercial, professional and residential applications where both environmental durability and high quality sound reproduction are required, but where project costs need to be tightly controlled.

The range comprises of 3 models – DVS 4, DVS 6 and DVS 8. Each comprising a 4”, 6” or 8” mid bass driver respectively, with a coaxially mounted 19 mm (0.75”) high frequency section, all mounted within a stylish and lightweight

injection-moulded surface-mount enclosure manufactured from UV / weather resistant ABS material. All DVS models are certified for water and dust ingress protection to IP64 standard and benefits from UL Listed status (UL 1480 and UL 2043). This makes DVS Series a perfectly capable performer in challenging interior areas such as swimming pools, saunas or work areas where unusually high levels of dust or moisture may be present, as well as typical outdoor applications where extreme environmental conditions are not a specific concern.

DVS Series is available in white or black as standard, and each model comes with colour-coded wall-mounting bracket and rubber cable connection gland included in the box, for simple and hassle-free on-site installation. No additional hardware required.

Features

- Range of 3 models – 4”, 6” and 8” driver complements.
- Weather resistant rated IP64 to EN60529 (IEC529) - suitable for outdoor use
- Stylish, durable ABS enclosure available in black or white
- UL Listed (UL 1480 and UL 2043)
- Painted steel yoke bracket supplied
- Low insertion loss integrated transformer versions available
- EN54 compliant models available

Applications

- Bars & restaurants
- Casinos
- Concourses
- Fitness centres & leisure facilities
- Hotels
- Museums & galleries
- Retail spaces & malls
- Theme parks & visitor attractions
- Corporate AV



SCAN FOR
PRODUCT DATA



DVS SERIES AT A GLANCE						
Model	Dispersion	Frequency Range (-10 dB)	Sensitivity	Rated SPL (avg.)	Rated power (@ 6 ohms)	Dimensions (H x W x D)
DVS 4 / DVS 4t	110°	60 Hz - 30 kHz	84 dB	100 dB	80 W	277 x 171 x 166 mm
DVS 6 / DVS 6t	90°	65 Hz - 30 kHz	88 dB	105 dB	120 W	341 x 213 x 217 mm
DVS 8 / DVS 8t	80°	60 Hz - 30 kHz	90 dB	108 dB	140 W	452 x 290 x 296 mm

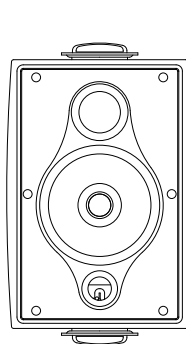

DVS 4 / DVS 4t

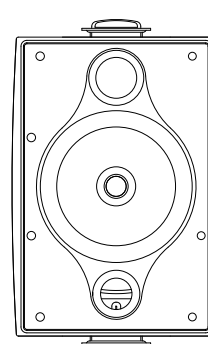

DVS 6 / DVS 6t

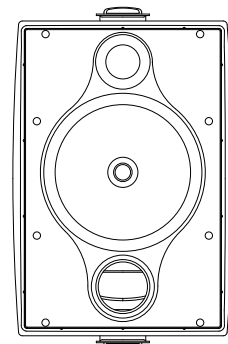

DVS 8 / DVS 8t

Discreet near-field in-wall loudspeaker systems

iW Series are a range of compact, ultra-discreet small-format installation loudspeakers aimed at the residential custom install, hotel, corporate AV and other applications where high quality audio is required from an in-wall mounted device. Designed primarily for installation into standard stud partition wall systems, it may also be used in cavity wall installations constructed with standard thickness drywall as well as a wide range of other wall construction types with a surface thickness of up to 25 mm (1").

With 5 models in the range, encompassing compact single driver devices (4" and 6"), a twin-driver model with both

Dual Concentric and additional bass driver for greater LF response and a subwoofer unit, the iW Series provides scope and versatility for a wide variety of near-field sound reinforcement applications. High power handling and efficient performance ensure these compact units are ideally suited to applications requiring the combination of premium sonic quality for music and speech reinforcement and exceptional reliability and intelligibility.

Features

- Extended frequency response and very low distortion
- Wide, controlled constant directivity dispersion for optimum coverage
- Discreet appearance, delivering high quality near-field coverage with minimal aesthetic impact
- UV and weather resistant UL 94V-0, ABS construction for structural integrity
- Dynamic high frequency protection
- Six-way self-aligning mounting system
- Ferrofluid-cooled neodymium high frequency driver

Applications

- Bars & restaurants
- Hotels
- Museums & galleries
- Retail spaces & malls
- Theme parks & visitor attractions
- Fitness centres & leisure facilities
- Corporate AV
- Conference rooms



SCAN FOR
PRODUCT DATA



IW SERIES AT A GLANCE						
Model	Dispersion	Frequency Range (-10 dB)	Sensitivity	Rated SPL (avg.)	Rated power (@ 8 ohms)	Dimensions (H x W x D)
iW 4DC	110°	73 Hz - 54 kHz	88 dB	106 dB	120 W	238 x 159 x 84 mm
iW 6DS	90°	44 Hz - 54 kHz	89 dB	108 dB	20 - 100 W	320 x 209 x 93 mm
iW 6TDC	90°	36 Hz - 54 kHz	91 dB	110 dB	20 - 180 W	473.5 x 227 x 99 mm
iW 62TDC	90°	34 Hz - 54 kHz	94 dB	117 dB	20 - 210 W	473.5 x 227 x 95.5 mm
iW 62TS	-	29 Hz - 110 Hz	94 dB	117 dB	400 W	473.5 x 227 x 95.5 mm

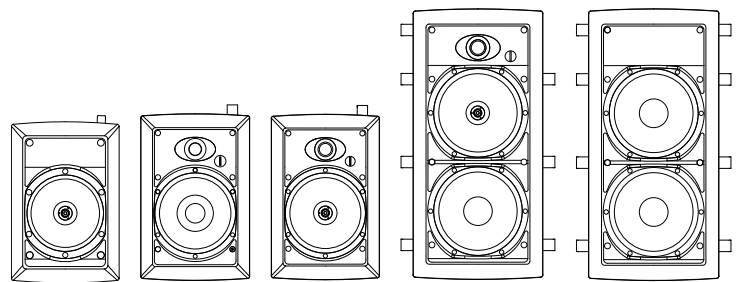

iW 4DC

iW 6DS

iW 6TDC

iW 62TDC

iW 62TS

Need a passive column solution?

Comprising of 3 models, VLS Series augments Tannoy's already strong offering to the 'architectural audio' market – where maximum intelligibility and minimum aesthetic impact are the driving concerns. Building upon the proven commercial success of its flagship QFlex self-powered steerable array system, VLS Series offers AV contractors and consultants an alternative solution in the shape of a passive device offering balance of performance and cost, when active beam-steering may neither be required nor affordable.

With transducer technology adapted from QFlex, coupled with an innovative new passive crossover network design, VLS Series is the first Tannoy product to incorporate FAST (Focussed Asymmetrical Shaping Technology), delivering unique acoustic performance benefits not previously seen across a full-range of passive column loudspeakers. Central to this is its asymmetrical vertical dispersion, gently shaping the acoustic coverage towards the lower quadrant of the vertical axis. By the nature of a typical application, an ideal column loudspeaker should be biased in the vertical plane, towards the audience and away from reflective surfaces above (like ceilings) which are detrimental to intelligibility. FAST also facilitates quicker, easier installation with less need for tilting or specific concern for optimal mounting height.

This performance is packaged in a slender and narrow profile, aesthetically refined, powder-coated aluminium chassis with curvilinear aluminium grille; ensuring a sleek aesthetic and ultra-discrete appearance. Each model is available in either black or white as standard, though custom RAL finishes are available at additional cost and lead-time.

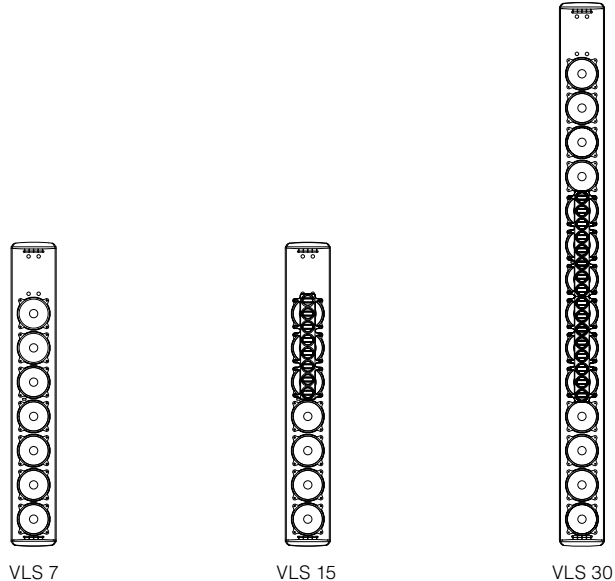

VLS 7

VLS 15

VLS 30

Features

- FAST (Focussed Asymmetrical Shaping Technology) delivers improved intelligibility in typical listening plane and greater flexibility in mounting location
- Asymmetrical vertical dispersion
- IP65 rated for water and dust ingress protection
- Sleek architecturally-sensitive profile
- Integrated low insertion loss transformer for 100 V / 70 V operation
- Easy to install, mounting brackets included
- Easily accessible transformer tapping switch
- Available in black or white

Applications

- Houses of worship
- Transportation hubs
- Retail spaces & concourses
- Conference rooms
- Lecture theatres
- Auditoria
- Convention centres
- Museums
- Stadium concourses
- Challenging acoustic spaces

VLS SERIES AT A GLANCE

Model	Dispersion	Frequency Range (-10 dB)	Sensitivity	Rated SPL (avg.)	Rated power	Dimensions (H x W x D)
VLS 7	130° horizontal +6° / -22° (-8° bias) vertical	110 Hz - 14 kHz	90 dB	112 dB	450 W @ 8 ohms	816.5 x 121 x 146 mm
VLS 15	130° horizontal +6° / -22° (-8° bias) vertical	110 Hz - 35 kHz	91 dB	114 dB	600 W @ 8 ohms	816.5 x 121 x 146 mm
VLS 30	130° horizontal +3° / -11° (-4° bias) vertical	90 Hz - 35 kHz	94 dB	120 dB	1200 W @ 4 ohms	1460.5 x 121 x 146 mm



SCAN FOR
PRODUCT DATA



Think FAST

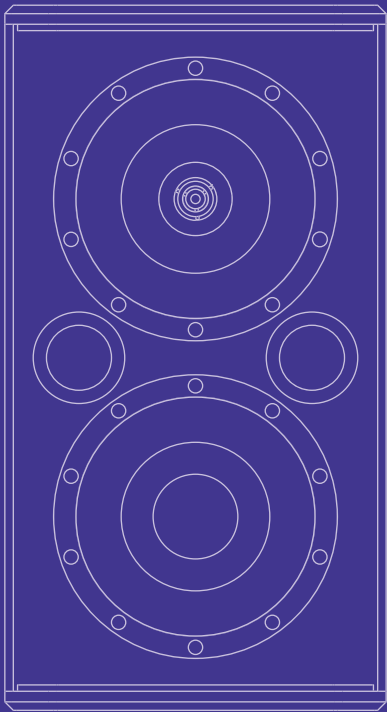

VX Series

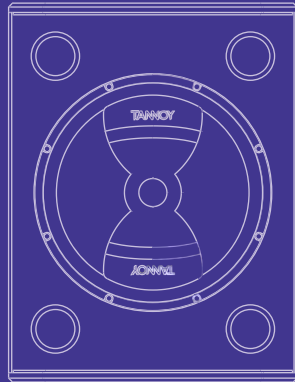

VQNET Series

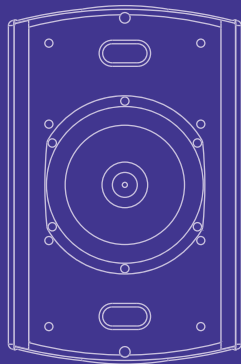
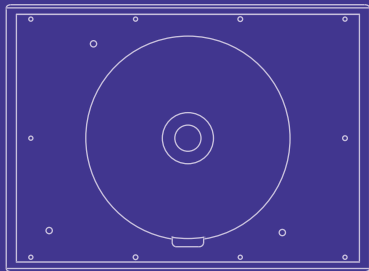
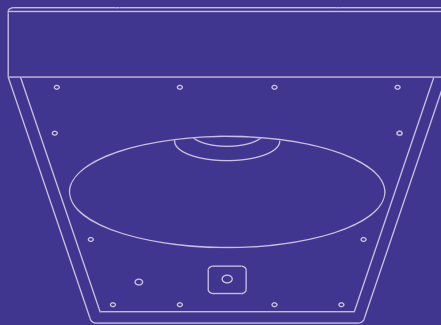

QFlex

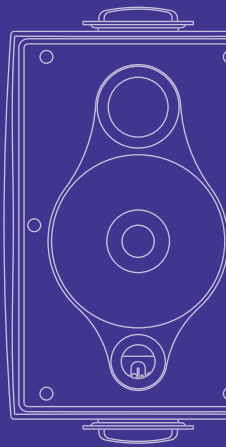
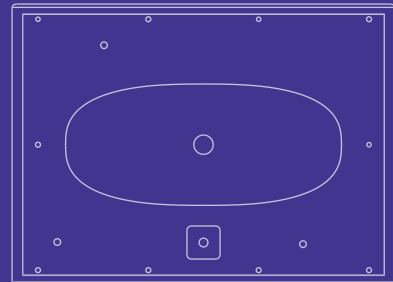
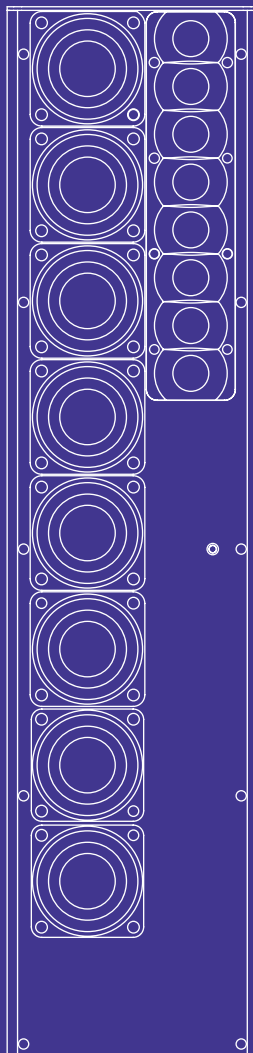

VQ Series

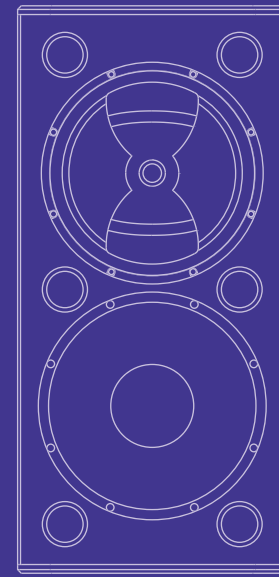
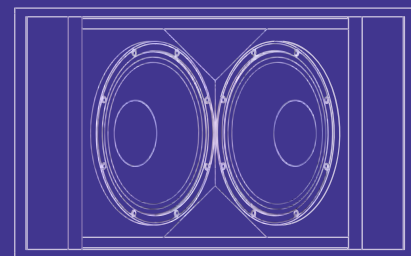
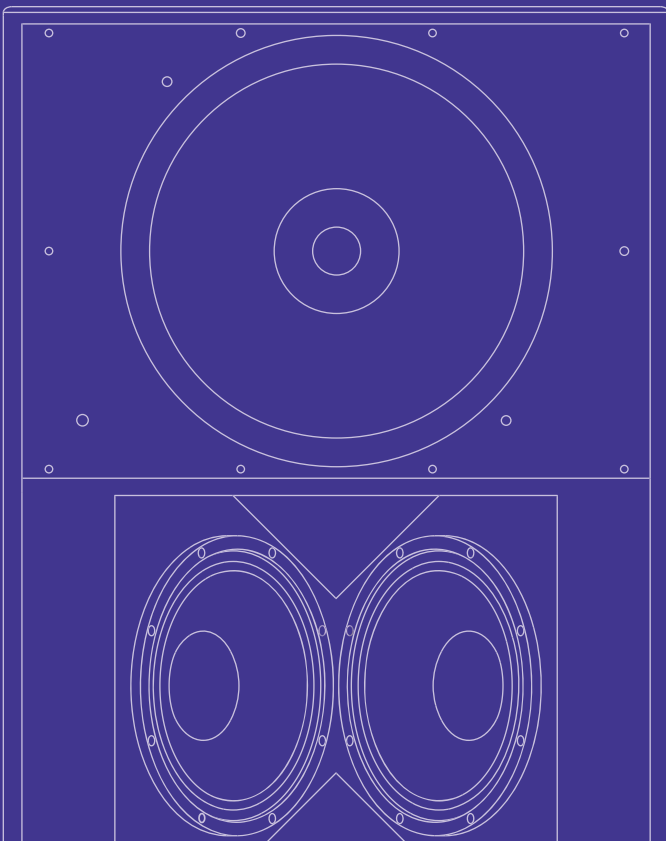

VXP Series

Performance Install

Tannoy has a long and distinguished heritage in public address sound reinforcement, having been active pioneers in the field since the 1930s. Recent decades of product development and specialisation have focused on the small and medium-scale sound reinforcement market, bringing to bear the unique characteristics of our Dual Concentric driver technology - excellent transient response, superior phase coherence and immediate presence and intelligibility - in compact loudspeaker devices designed for short and medium throw applications. The recent introduction of VX Series - and its self-powered VXP variant, featuring Lab.gruppen IDEEA™ power modules - underline Tannoy's robust offering in this market, building on the commercial success of its V Series predecessor with an expanded range of models and driver configurations.

Recent years have seen a move towards catering for the higher SPL application market with the introduction of the innovative VQ Series - high performance, high output, point-source modular system. Designed specifically for applications where very high output levels - typically achieved by resorting to line array systems - are achieved with less distortion, more consistent pattern control and in a more compact system, with less impact on architectural aesthetics. VQ Series has found success in the large scale House of Worship and sports arena and stadia markets, as well as growing reputation as a powerful high-energy dance music nightclub system.

In addition to conventional point-source devices, Tannoy also leads in the field of high performance digitally-steerable column arrays in the shape of QFlex. Designed to overcome challenging acoustics in spaces such as traditional churches, transport hubs and auditoria, QFlex represents the pinnacle of Tannoy's loudspeaker development, combining cutting edge electronics, software and transducer technology.

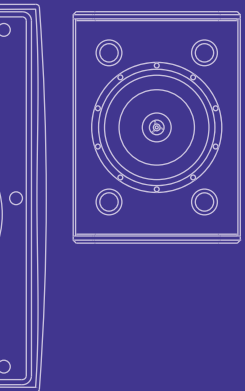

Hakasan Restaurant - DUBAI



V to the power of X

With an expanded range of enclosures and transducer complements, VX Series builds on the success of the renowned V Series, combining next-generation Dual Concentric driver technology with smart, ergonomic, portable and install-friendly new cabinet designs, enhanced build quality, and carefully thought-out functionality. VX Series gives installers, systems designers and engineers that critical advantage.

With 10 passive models in the range, each tailor-designed to satisfy specific applications, ranging from small format corporate AV to demanding high SPL nightclub and live sound reinforcement, versatility and flexibility within the

range is assured. New configurations include models with an additional driver for improved LF performance as well as HP PowerDual equipped models and high-directivity variants featuring Tannoy's innovative new Q-Centric Waveguide™ (QCW™) for greater coverage control in the vertical axis.

All models are finished in highly durable scuff-resistant paint – available in black and white as standard - with matching grille assembly and mounting hardware. Custom specified RAL colours are available to perfectly match those aesthetically sensitive installations, while weather-protected versions are also available, for demanding outdoor applications.

Features

- 10 passive models to suit many potential applications
- High efficiency and low distortion
- Integrip™ carrying points for portability
- Dual Concentric driver technology for renowned point-source performance
- Weather protected (WP) specification
- Engineered and built in UK
- Q-Centric Waveguide for tighter vertical pattern control and greater forward gain, on all 'Q' models
- Twin-driver equipped models for greater LF extension

Applications

- Auditoria & lecture theatres
- Bars & restaurants
- Corporate AV
- Fitness centres & leisure facilities
- Houses of worship
- Music & performance venues
- Nightclubs
- Portable PA
- Theme parks & visitor attractions
- Retail spaces & malls
- Performing arts spaces



SCAN FOR
PRODUCT DATA



VX SERIES AT A GLANCE

Model	Dispersion	Frequency Range (-10 dB)	Sensitivity	Rated SPL (avg.)	Rated power (@ 8 ohms)	Weight	Dimensions (H x W x D)
VX 5.2	120 x 90°	65 Hz - 45 kHz	90 dB	111 dB	260 W	5 kg (11.0 lbs)	333 x 180 x 200 mm
VX 6	90°	80 Hz - 45 kHz	91 dB	111 dB	200 W	5.5 kg (12.1 lbs)	333 x 225 x 215 mm
VX 8	90°	62 Hz - 45 kHz	92 dB	113 dB	260 W	8.5 kg (18.7 lbs)	388 x 280 x 275 mm
VX 8.2	90°	60 Hz - 45 kHz	92 dB	115 dB	400 W	15.5 kg (34.2 lbs)	590 x 280 x 275 mm
VX 12	90°	55 Hz - 38 kHz	97 dB	120 dB	400 W	17 kg (37.5 lbs)	486 x 370 x 360 mm
VX 12HP	75°	60 Hz - 30 kHz	99 dB	124 dB	700 W	21.5 kg (47.4 lbs)	486 x 370 x 360 mm
VX 12Q	75 x 40°	60 Hz - 30 kHz	99 dB	124 dB	700 W	21 kg (46.3 lbs)	486 x 370 x 360 mm
VX 12.2Q	75 x 40°	55 Hz - 30 kHz	99 dB	126 dB	1000 W	33.5 kg (73.9 lbs)	780 x 370 x 360 mm
VX 15HP	75°	58 Hz - 30 kHz	100 dB	126 dB	800 W	26.5 kg (58.4 lbs)	590 x 450 x 420 mm
VX 15Q	75 x 40°	58 Hz - 30 kHz	100 dB	126 dB	800 W	27 kg (59.5 lbs)	590 x 450 x 420 mm

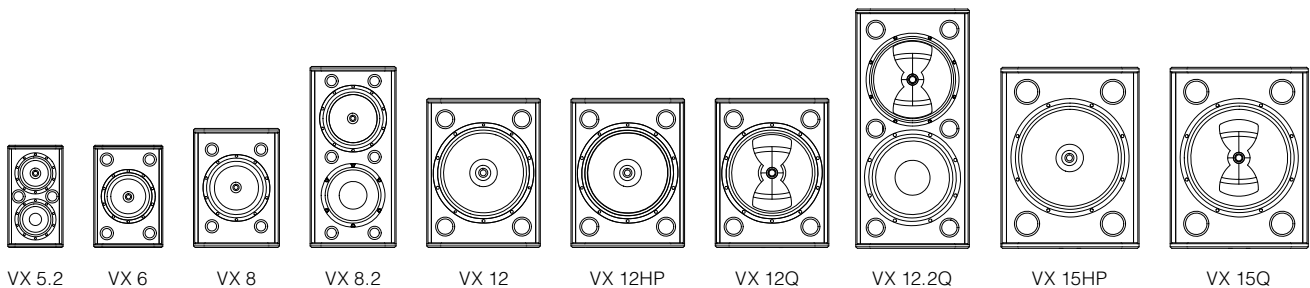

VX 5.2

VX 6

VX 8

VX 8.2

VX 12

VX 12HP

VX 12Q

VX 12.2Q

VX 15HP

VX 15Q



A great IDEEA in every box

VXP Series is a self-powered line of sound reinforcement loudspeakers based on the passive VX Series products, and featuring the revolutionary IDEEA power module from Lab.gruppen - a first for the Swedish amplification pioneers. The product of tour-honed design experience, the world-renowned manufacturer's ultra-reliable, energy-efficient amplifier technology perfectly complements the acoustic excellence of Tannoy's VX loudspeaker designs. The result is the all-new VXP Series: audible superiority in a self-powered box.

This is the first collaboration on a self-powered loudspeaker product between Tannoy and sister company Lab.gruppen, and the only product range to harness the respective strengths

of both brands and bring them to bear on the installed sound and portable PA markets. The perfectly matched Lab.gruppen IDEEA modules are designed to handle the demands of fixed installation audio, with the inherent extended duty cycles of around-the-clock operation and very high performance demands, while offering the durability, unmatched power output and clarity required for high performance sound reinforcement.

When it comes to choosing a self-powered loudspeaker system that gives you not only flexibility within the model range and excellent sonic performance but also reliable and efficient electronics, it's time to think inside the box. Think VXP Series.

Features

- 9 self-powered models to suit every potential application
- Integrated Lab.gruppen Intelli-Drive Energy Efficient Amplifier IDEEA electronics providing ultra-reliable Class D amplification
- Auto switch to standby after period of no signal
- High efficiency and low distortion
- Integrip carrying points for portability
- Pole-mountable for portable PA applications
- Engineered and built in UK

Applications

- Auditoria & lecture theatres
- Bars & restaurants
- Corporate AV
- Fitness centres & leisure facilities
- Houses of worship
- Music & performance venues
- Nightclubs
- Portable PA
- Theme parks & visitor attractions
- Retail spaces & malls
- Performing arts spaces



SCAN FOR
PRODUCT DATA



VXP SERIES AT A GLANCE

Model	Dispersion	Frequency Range (-10 dB full-range mode)	Rated SPL (avg.)	Stand By Power	Idle Power	Operating Voltage	Weight	Dimensions (H x W x D)
VXP 6	90°	80 Hz - 45 kHz	111 dB	< 0.5 W	10 W	70 - 265 V	7 kg (15.4 lbs)	333 x 225 x 215 mm
VXP 8	90°	67 Hz - 45 kHz	113 dB	< 0.5 W	10 W	70 - 265 V	10 kg (22 lbs)	388 x 280 x 275 mm
VXP 8.2	90°	60 Hz - 45 kHz	115 dB	< 0.5 W	10 W	70 - 265 V	17.5 kg (38.6 lbs)	590 x 280 x 275 mm
VXP 12	90°	55 Hz - 38 kHz	120 dB	< 0.5 W	10 W	70 - 265 V	19 kg (41.9 lbs)	486 x 370 x 360 mm
VXP 12HP	75°	60 Hz - 30 kHz	124 dB	< 0.5 W	10 W	70 - 265 V	23.5 kg (51.8 lbs)	486 x 370 x 360 mm
VXP 12Q	75 x 40°	60 Hz - 30 kHz	124 dB	< 0.5 W	10 W	70 - 265 V	23 kg (50.7 lbs)	486 x 370 x 360 mm
VXP 12.2Q	75 x 40°	47 Hz - 30 kHz	126 dB	< 0.5 W	10 W	70 - 265 V	35 kg (77.2 lbs)	780 x 370 x 360 mm
VXP 15HP	75°	47 Hz - 30 kHz	126 dB	< 0.5 W	10 W	70 - 265 V	29 kg (63.9 lbs)	590 x 450 x 420 mm
VXP 15Q	75 x 40°	47 Hz - 30 kHz	126 dB	< 0.5 W	10 W	70 - 265 V	29 kg (63.9 lbs)	590 x 450 x 420 mm

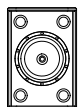

VXP 6

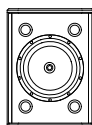

VXP 8

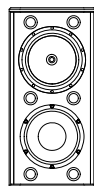

VXP 8.2

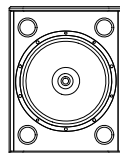

VXP 12

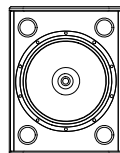

VXP 12HP

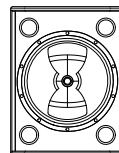

VXP 12Q

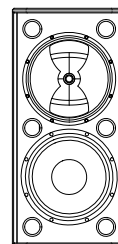

VXP 12.2Q

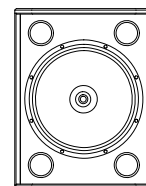

VXP 15HP

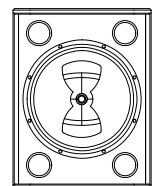

VXP 15Q



At the heart of the performance

VQ Series is our large-format, high SPL performance audio loudspeaker system designed for any application where precise directional control, outstanding sonic performance, and high SPL's are critical issues; such as houses of worship, sports arenas, large dance clubs, live music venues, performing arts theatres, and large-scale corporate AV.

At the heart of VQ Series is a patented point-source horn-loaded transducer design. Our unique approach in keeping what is effectively a Dual Concentric behind a single horn gives us many performance advantages. The sound quality, accuracy and control of coverage is second to none, providing definitive and measurable advantages over multiple-horn and co-axial designs – and high SPL, long throw output

on a par with equivalent-sized line array systems, without the inherent disadvantages (eg. distortion levels, high frequency pattern control).

VQ Series is available as self-contained 3-way systems (VQ 60 and VQ 100) which combine the unique Mid-High horn device with a 2 x 12" LF section for full-range performance in a single enclosure; or as modular components – comprising separate Mid-High (MH), Down-Firing (DF) and LF devices – facilitating the design and installation of tightly packed point-source clusters, tailored for specific medium or long-throw applications, including sports arena, auditoria or outdoor performance venue installs.

Features

- Point-source design featuring patented PSW™ horn technology
- Modular system design for assembling point-source clusters
- Class leading directivity characteristics
- Extremely high sensitivity, therefore high SPL's can be achieved with a very modest amount of amplifier power
- Exceptional transient response
- Downloadable software tool for designing predictable clusters

Applications

- Corporate AV
- Houses of worship
- Live music & performance venues
- Nightclubs
- Performing arts spaces
- Portable PA
- Sports arenas & stadia
- Theme parks
- Auditoria & lecture theatres
- Fitness centres & leisure facilities



SCAN FOR
PRODUCT DATA



VQ SERIES AT A GLANCE

Model	Dispersion	Frequency Range (-10 dB)	Sensitivity	Rated SPL (avg.)	Rated power	Weight	Dimensions (H x W x D)
VQ 60	60° conical	90 Hz - 27 kHz	115 dB	138 dB	400 W @ 8 ohms	77 kg (169.8 lbs)	925 x 694 x 515 mm
VQ 100	100° conical	90 Hz - 27 kHz	110 dB	134 dB	400 W @ 8 ohms	65 kg (143.3 lbs)	925 x 694 x 515 mm
VQ 40MH	40° conical	350 Hz - 27 kHz	117 dB	140 dB	400 W @ 8 ohms	46.5 kg (102.5 lbs)	510 x 694 x 515 mm
VQ 64MH	60 x 40°	350 Hz - 27 kHz	115 dB	138 dB	400 W @ 8 ohms	45.5 kg (100.3 lbs)	510 x 694 x 515 mm
VQ 95MH	90 x 50°	350 Hz - 27 kHz	111 dB	134 dB	400 W @ 8 ohms	35.5 kg (78.3 lbs)	510 x 694 x 515 mm
VQ 40DF	40° conical	350 Hz - 27 kHz	112 dB	135 dB	400 W	32 kg (70.5 lbs)	460 x 694 x 497 mm
VQ 64DF	60 x 40°	350 Hz - 27 kHz	111 dB	134 dB	400 W	30.5 kg (67.2 lbs)	460 x 694 x 497 mm
VQ 85DF	80 x 50°	350 Hz - 27 kHz	110 dB	134 dB	400 W	28 kg (61.7 lbs)	460 x 694 x 497 mm
VQ MB	-	90 Hz - 600 Hz	105 dB	135 dB	2 kW @ 4 ohms	37 kg (81.6 lbs)	433 x 694 x 515 mm
VS 15DR	-	38 Hz - 4.5 kHz	100 dB	130 dB	1.2 - 2 kW @ 8 ohms	33 kg (72.8 lbs)	510 x 694 x 515 mm

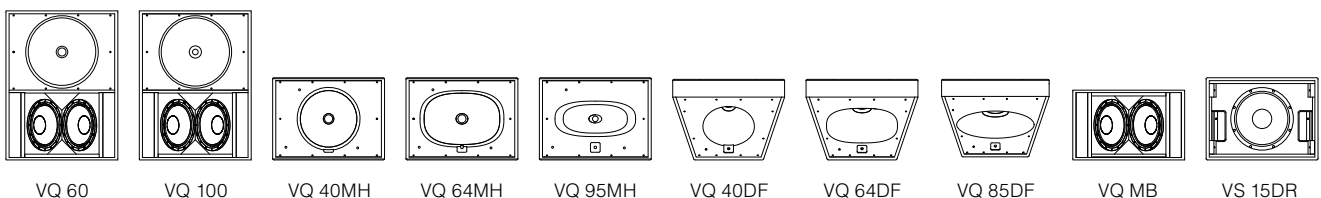

VQ 60

VQ 100

VQ 40MH

VQ 64MH

VQ 95MH

VQ 40DF

VQ 64DF

VQ 85DF

VQ MB

VS 15DR



Uncompromising performance...

Point-Source Waveguide

Each VQ loudspeaker product utilises a unique driver technology to radiate a coherent single point-source for superior dispersion control when coupled to our proprietary PSW (Point-Source Waveguide). This advanced design aligns the acoustical centres of the transducers providing a single coherent wave-front emanating from the throat. The PSW waveguide achieves an optimum balance of extremely well controlled coverage, smooth frequency response, and natural sound character. The driver uses two concentric annular ring diaphragms. The larger of the two has a 3.5" voice coil and reproduces frequencies from 400 Hz to 7 kHz. One major advantage here is that there is no crossover anywhere near the vocal region ensuring the most natural and phase coherent reproduction at this critical area. The 2" HF diaphragm takes over at 7 kHz to 22 kHz by way of a passive or an active crossover. The external casting features extensive heat-sinking ensuring good heat transfer for high power handling and very low power compression.

This unique combination of point-source driver, waveguide and horn technology results in unprecedented degrees of clarity, intelligibility and true broadband pattern control.





...through cutting edge technology

Efficiency. Power. Clarity.

As well as VQ's class-leading directivity characteristics, each device's high sensitivity ensures exceptionally high SPL levels can be achieved with a very modest amount of amplifier power. As a benchmark example, a single passive VQ 60 enclosure will produce 115 dB for just 1 watt; and a sustained 138 dB (144 dB peak) for only 200 watts of amplifier power - with a tightly controlled 60° dispersion pattern above 800 Hz delivering exceptionally even coverage and excellent clarity. Just one VQ 60 box will produce similar SPL and throw as a typical 3-box line array system, with greater consistency in pattern control - even at high frequency bands.

Modular components for application specific designs

Versatility is the key with VQ Series thanks to its modular and compact enclosure format. This modular design approach, with carefully considered form-factors and choice of point-source coverage patterns allows the designer to create tightly packed, scalable clustered arrays for very specific medium and long-throw purposes - tailored to overcome the demands of a given application. Designing point-source clusters is made simple via our proprietary VQ GLL tool, allowing designers to accurately predict the performance of a given VQ cluster array, modelled as a single point-source device in EASE. This is available to download free from Tannoy via the AET resource site (aetgroup.tc)

Assembly and installation of VQ clusters is facilitated via our custom designed hardware components. Our easy to rig flyware boasts an industry leading 10:1 safety factor for complete confidence and peace of mind.



VQNET

All VQ devices are available in self-powered DSP, networked VNET variants, in the form of VQNET. Each VQNET product features fully integrated cutting edge Digital Signal Processing, network control and dual channel Class D amplification. Each VQ NET loudspeaker is fully VNET compliant and is fully calibrated at the factory, avoiding the need to input the correct speaker management settings or dynamics at the point of install. This frees the installer to concentrate instead on room measurement and system optimisation. All devices on the network can be tuned remotely from a Windows laptop via the VNET software environment (free to download) making commissioning simple and hassle-free.

As well as the added convenience and simplicity that a self-powered, networkable PA solution brings to permanent install – dispensing with the need for separate power amplification racks, ventilation, long runs of speaker cable, etc – VQNET also offers up a versatile and powerful option on the portable performance audio PA front. We have developed a tailored 'live' variant of VQNET in the form of VQ Live especially for these applications, delivering all of the sonic and practical advantages of VQ in a road-ready package.

Features

- Point-source design featuring patented PSW horn technology
- Modular system design for assembling point-source clusters
- Excellent phase coherence
- Perfect time alignment without the associated problems of multi source interference
- Class leading directivity characteristics
- Extremely high sensitivity, therefore high SPL's can be achieved with a very modest amount of amplifier power
- Exceptional transient response
- Standalone devices or combined to form cluster/arrays
- Range of flying hardware available
- Downloadable software tool for designing predictable clusters

VQNET SERIES AT A GLANCE

Model	Dispersion	Frequency Range (-10 dB)	Rated SPL (avg.)	Rated power	Weight	Dimensions (H x W x D)
VQNET 60	60° conical	90 Hz - 27 kHz	138 dB	400 W MF / HF, 800 W LF	80 kg (176.4 lbs)	925 x 694 x 515 mm
VQNET 100	100° conical	90 Hz - 27 kHz	134 dB	400 W MF / HF, 800 W LF	68 kg (149.9 lbs)	925 x 694 x 515 mm
VQNET 40MH	40 x 40°	350 Hz - 27 kHz	140 dB	400 W MF / 200 W HF	32.5 kg (71.5 lbs)	510 x 694 x 515 mm
VQNET 64MH	60 x 40°	350 Hz - 27 kHz	138 dB	400 W MF / 200 W HF	48.5 kg (106.9 lbs)	510 x 694 x 515 mm
VQNET 95MH	90 x 50°	350 Hz - 27 kHz	134 dB	400 W MF / 200 W HF	39 kg (86 lbs)	510 x 694 x 515 mm
VQNET 40DF	40 x 40°	350 Hz - 27 kHz	135 dB	400 W MF / 200 W HF	35.5 kg (78.3 lbs)	500 x 694 x 515 mm
VQNET 64DF	60 x 40°	350 Hz - 27 kHz	134 dB	400 W MF / 200 W HF	32.5kg (71.7 lbs)	500 x 694 x 515 mm
VQNET 85DF	80x 50°	350 Hz - 27 kHz	133 dB	400 W MF / 200 W HF	31 kg (68.3 lbs)	500 x 694 x 515 mm
VQNET MB	-	90 Hz - 600Hz	135 dB	2000 W	41 kg (90.2 lbs)	433 x 694 x 515 mm
VNET 15DR	-	38 Hz - 4.5 kHz	130 dB	1200 W	33 kg (72.8 lbs)	510 x 694 x 515 mm

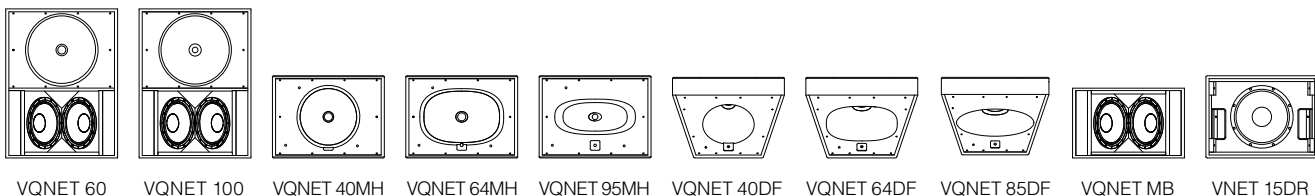

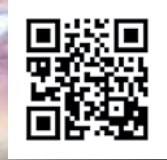

SCAN FOR
PRODUCT DATA

Hard Rock Cafe - DUBAI



Flagship active point-source system

Central Station, Glasgow - UK



SCAN FOR
PRODUCT DATA



A new angle...

...on steered sound

QFlex is a range of digitally steerable, multi-channel, column array loudspeaker systems for the professional installed audio market. QFlex was conceived and designed to offer an effective self-contained solution for applications with challenging acoustic conditions, such as houses of worship, transportation hubs, convention centres, conference facilities, shopping malls, performing arts centres and museums.

The acoustical principles and physics that govern beam-steering loudspeakers are well established and documented, and therefore not subject to patents. However, the specifics of design, engineering and manufacturing are critical, since it's the implementation of the principles that will determine sound quality, beam control range, uniformity of dispersion, and product reliability. On all these counts, Tannoy's QFlex range defines the global standard for column array beam-steering technology. We determined that full-range beam-steering would be a prerequisite from the outset, rather than placing emphasis only on vocal regions as with competitive products.

In the most difficult acoustical environments - whether in traditional cathedrals or vast ultra-modern airport terminals - QFlex loudspeakers precisely control directivity in the vertical axis, resulting in optimal venue coverage and the best possible direct-to-reverberant ratio. Acoustic output is precisely aimed where it needs to be delivered, greatly reducing reflections from

hard surfaces – even when the QFlex column must be mounted well above audience level. Whether the audio program is music or critical voice announcements as part of a life safety or mass notification system QFlex will provide exceptionally high voice intelligibility and full-bodied, natural music reproduction. Also, compared to implementing acoustical treatments or even deploying competitive beam-steering loudspeakers, a QFlex solution will result in cost savings coupled with superior performance.

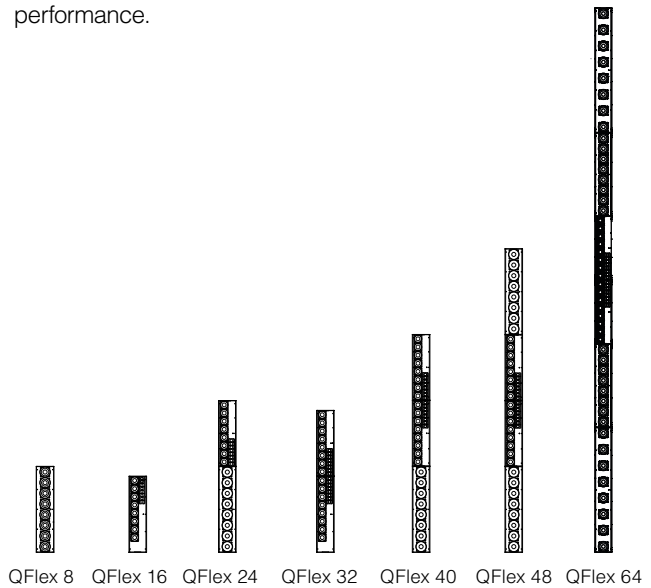

Features

- Extremely intelligible speech and music reinforcement
- Class-leading steering control (+/- 70 degrees)
- Sleek, low-impact aesthetic design
- Intuitive BeamEngine™ GUI
- Integrated cutting edge VNET DSP, network control and amplification
- Fully PA/VA compliant
- AES / Dante™ digital audio connectivity (optional Dante / VNET bridge required)
- IP54 Certified (optional)
- Custom colour options

Applications

- Houses of worship
- Transportation hubs
- Museums
- Shopping malls
- Theatres & auditoria
- Government buildings
- Conference facilities
- Hotel ballrooms
- Corporate HQ atria

QFLEX SERIES AT A GLANCE

Model	Dispersion (Horizontal)	Frequency Range (-10 dB)	Effective Range	Rated SPL (avg.)	LF Beam Control Limit	Dimensions (H x W x D)
QFlex 8	120°	110 Hz - 4 kHz	20 m (66 ft)	92 dB	700 Hz	840 x 172 x 150 mm
QFlex 16	120°	130 Hz - 20 kHz	25 m (82 ft)	94 dB	700 Hz	744 x 172 x 150 mm
QFlex 24	120°	110 Hz - 20 kHz	40 m (131 ft)	96 dB	400 Hz	1483 x 172 x 150 mm
QFlex 32	120°	130 Hz - 20 kHz	50 m (165 ft)	100 dB	400 Hz	1387 x 172 x 150 mm
QFlex 40	120°	110 Hz - 20 kHz	70 m (231 ft)	100 dB	250 Hz	2127 x 172 x 150 mm
QFlex 48	120°	110 Hz - 20 kHz	80 m (263 ft)	101.5 dB	200 Hz	2967 x 172 x 150 mm
QFlex 64	120°	110 Hz - 20 kHz	Up to 100 m (328ft)	103 dB	110 Hz	5487 x 171.5 x 150 mm

Kameha Grand hotel, Bonn - GERMANY



The steerable column has evolved

Comprehensive connectivity

QFlex is designed to allow fast, direct and trouble-free interfacing with virtually any type of audio system. Standard audio inputs are balanced analogue and AES3 digital, each with a loop-through link output. Terminations are on installation-standard Euroblock plug-in connectors. As an option, QFlex offers a VNET / AES break-in interface that allows the VNET network and AES3 audio signal to share the same Cat-5 cable. Also available is the Constant Voltage Interface, which steps down the audio signal from 70 V / 100 V to line level for direct connection to a QFlex system. And, for the fully networked future, just one optional Dante network bridge connects all QFlex systems in a zone to Audinate's Dante digital audio network.

BeamEngine GUI for precise coverage configuration

The intuitive BeamEngine GUI is a Windows™ based program that enables a system designer to specify a target area and then generate a steering algorithm tailored for optimum coverage of that area. BeamEngine graphically represents the sectional view (elevation) of the audience area as well as the location and aiming angle of the QFlex array. The resultant steering algorithm is saved and loaded into the QFlex DSP via the VNET software. For more resolute and comprehensive acoustical simulations, the balloon DLL can be exported for utilisation in EASE or CATT Acoustic™ acoustical modeling software programs.

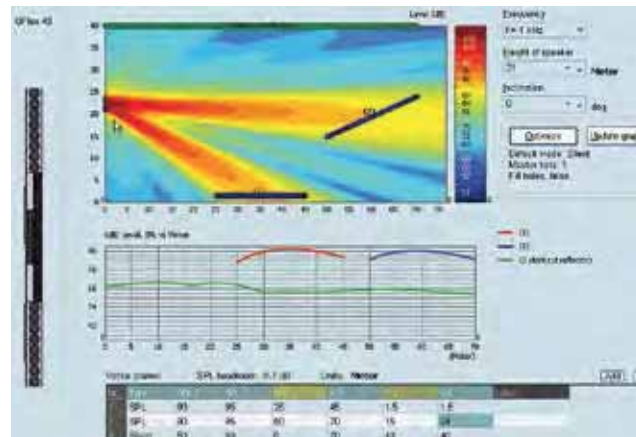



PA/VA standards compliance

Recent upgrades deliver the most comprehensive safety and monitoring facilities available, making QFlex fully compliant in any life safety environment. A new pilot tone detection feature enables constant checking of the complete audio signal path and cable integrity, meeting BS5839 requirements. Input switching can be implemented should the pilot tone indicate primary input failure, giving full system redundancy. For larger QFlex networks, the Sentinel SM1 System Monitor provides complete system-wide fault monitoring and reporting. Built on a thoroughly proven processing platform, Sentinel monitors the entire audio system as well as any controlling PCs, reporting problems via relay contacts and indicating faults on the front panel display complemented by an onboard alarm.



VNET monitoring and control

QFlex is fully compatible with Tannoy's proprietary VNET monitoring and control protocol, allowing QFlex loudspeakers to share the same network as other VNET-compatible Tannoy loudspeakers and subwoofers. Because VNET supports a free network topology, loudspeakers may be linked in daisy-chain or star topologies, or any combination of the two. The supplied VNET software program supervises and controls all commissioning and performance monitoring functions.

Weather protected

Weather protected (WP) versions of QFlex are available which provide protection against water and dust ingress to IP54 standard. These enhanced QFlex models benefit from gasket sealed enclosures, solid aluminium rear panels, grade 304 stainless steel mounting hardware and sealed cable gland on the input and power connector. This specification is available with additional lead-time on delivery and makes QFlex capable of operating in more challenging environments where limited moisture and dust/airborne contaminants are an issue, such as railway stations.

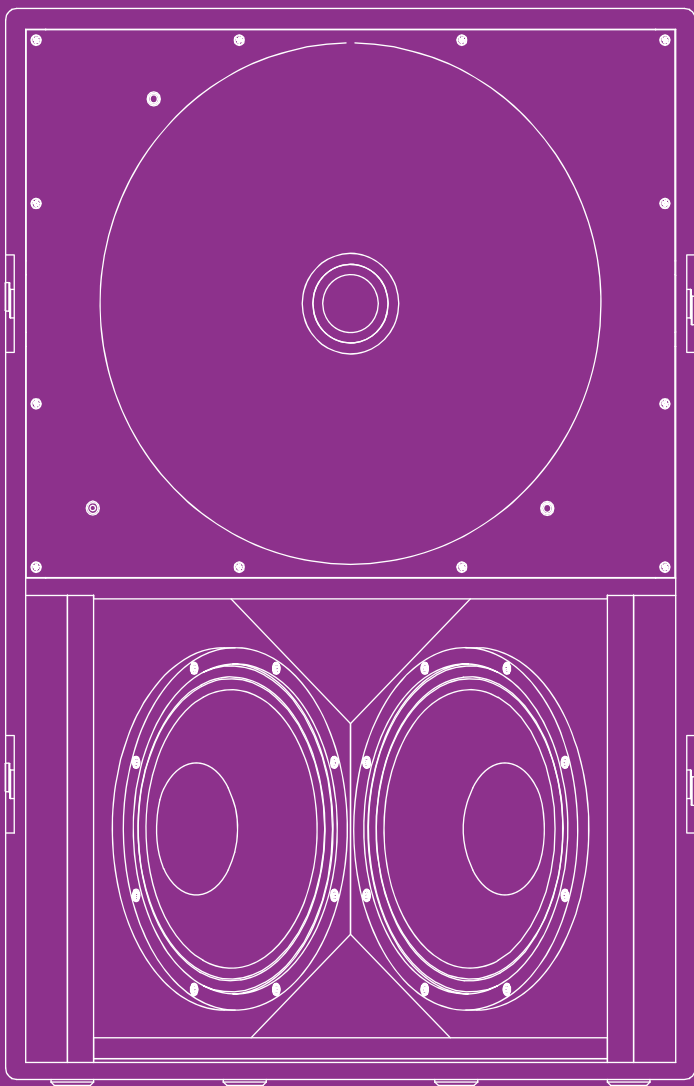

VQ Live

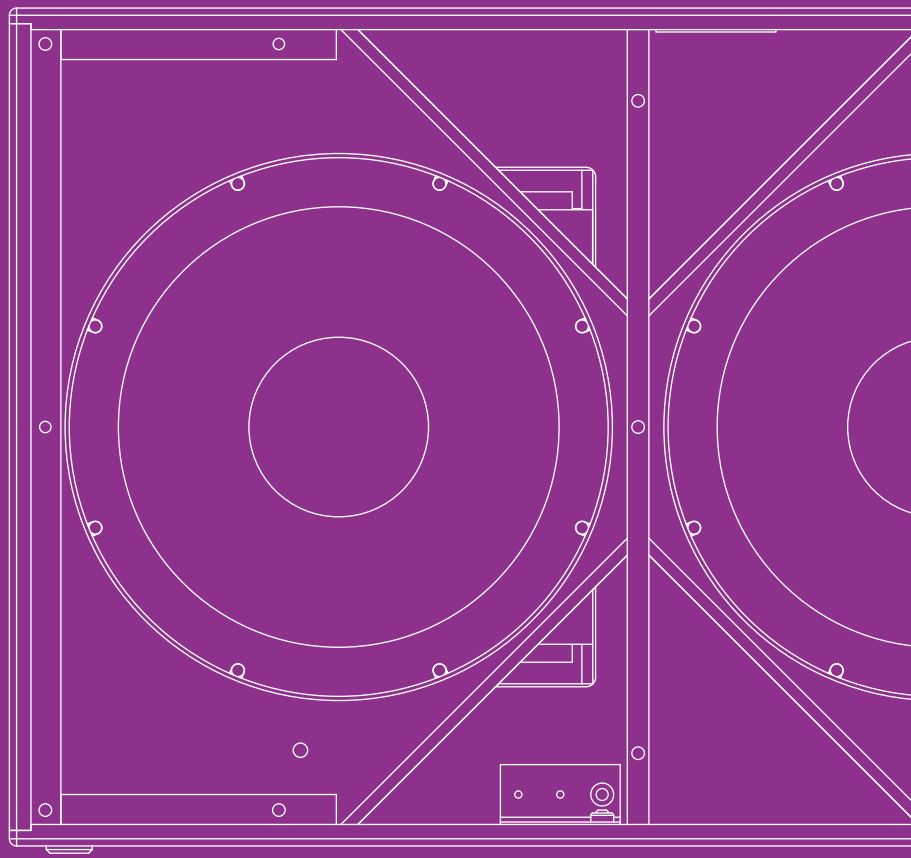

Live / Portable AV

For many years Tannoy offered only small scale portable public address and 'corporate AV' solutions. However this changed with the recent introduction of VQ Live - our medium/large scale self-powered performance PA system.

Evolved from the point-source technology developed for the install-oriented VQ Series, VQ Live repackaged the stunning sonic performance of VQ Series into a road-ready, self-contained live PA system, ideal for ground-stacked live music or performance audio applications such as small-to-medium size gigs and venues and theatres.

With 3-way full-range top boxes (arrayable for wider dispersion) and large format subwoofer devices, VQ Live gives you the tools to deploy premium quality high SPL audio coverage in both fixed venues and temporary event setups. In addition to VQ Live, we have also introduced the new VX and VXP Series (see Performance Install section) and VLS Series (see Commercial Install section) for further portable AV sound solutions, when used in combination with the correct polemount and subwoofer devices.

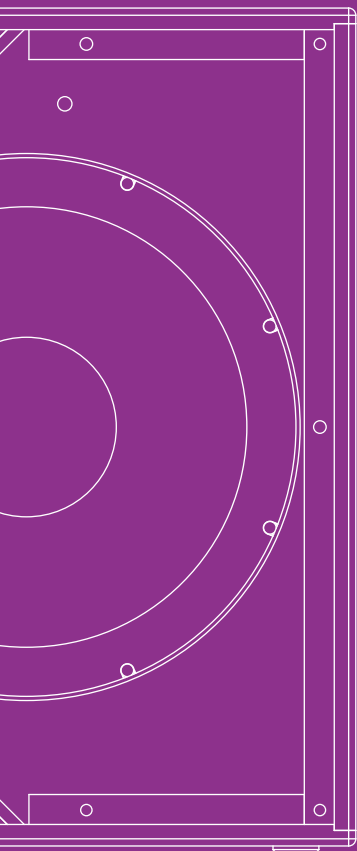



Taking precision performance on the road

Evolved from the technology developed for use in the installed sound VQ Series products and its self-powered VNET-enabled counterpart VQnet Series, VQ Live is a step in a new direction for Tannoy, combining our renowned precise sonic performance characteristics with high SPL, long throw and road-ready capability to form a truly innovative new live PA system aimed at mid to large scale performance audio applications.

VQ Live offers significant and tangible benefits over many existing live sound systems: sonic superiority, less boxes required, lower costs and full VNET implementation (allowing system setup and on-going venue network control). VQ Live has the potential to be a true line array killer.

Requiring no separate amp racks or DSP, very low power consumption, and far less warehouse and truck space than both conventional or line array systems, the VQ Live ticks all the right boxes whether you are a rental/hire company owner or an engineer. Typically, a ratio of around a third less VQ cabinets are required versus other competitive systems is to be expected, and so full system price and power consumption is greatly reduced as well.

With a maximum continuous SPL of 138 dB (144 dB peak), extremely well defined coverage and pattern control not to mention a remarkably low amount of rear rejection, VQ Live represents an enticing new possibility in performance audio. Rugged road-ready build quality, including Line-X coating as standard, and an innovative wheeled dolly and cabinet cover system makes for simple transit and venue setup. VQ Live defines a new class of live PA system.

VQ LIVE SERIES AT A GLANCE

Model	Dispersion	Frequency Range (-10 dB)	Rated SPL (avg.)	Rated power	Weight	Dimensions (H x W x D)
VQNET 60 LIVE	60° conical	90 Hz - 27 kHz	LF, 134 dB MF / HF, 136 dB	LF, 800 W MF / HF, 400 W	86.5 kg (190.6 lbs)	925 x 620 x 502 mm
VNET 218DR LIVE	-	24 Hz - 1.5 kHz	137 dB	2500 W	110 kg (232 lbs)	700 x 1050 x 850 mm



SCAN FOR
PRODUCT DATA



Features

- Road-ready
- Unrivalled clarity
- True constant directivity
- Predictable SPL coverage
- Excellent phase coherence
- Less boxes required, less cost
- Extremely high sensitivity, 138 dB (144 dB peak) sustained output
- Ergonomic cabinet design and dolly board for easy transit and rigging
- VNET implementation – real-time diagnostics and remote commissioning
- Line-X cabinet coating for extreme durability

Applications

- Portable PA
- Corporate AV
- Performing arts
- Live music venues
- Temporary events
- Visitor attractions

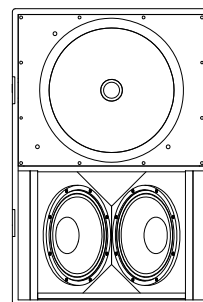

VQNET 60 LIVE

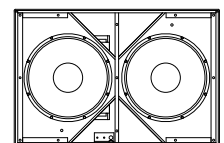

VQNET 218 DR LIVE

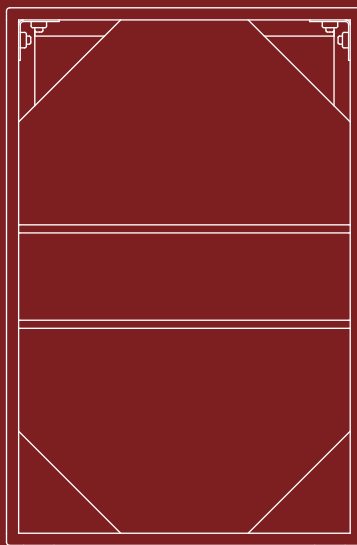
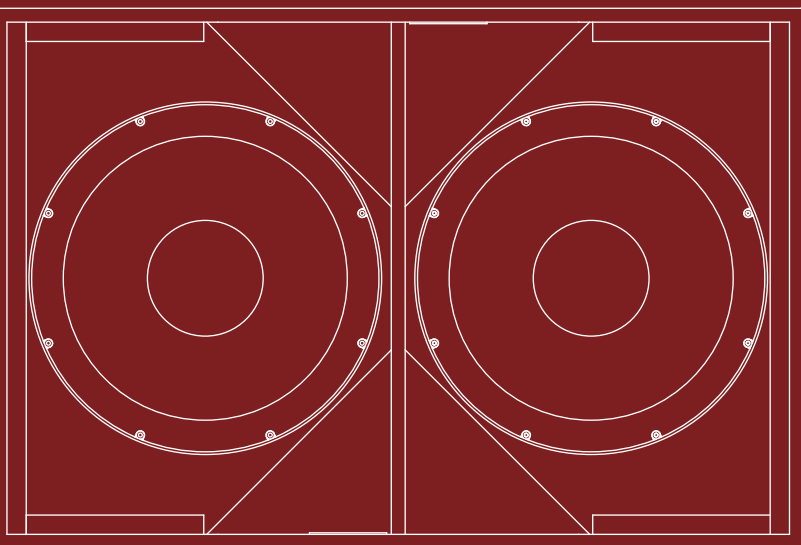
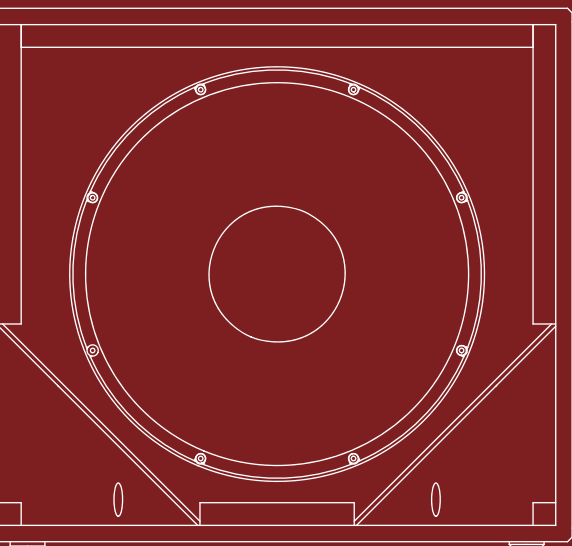
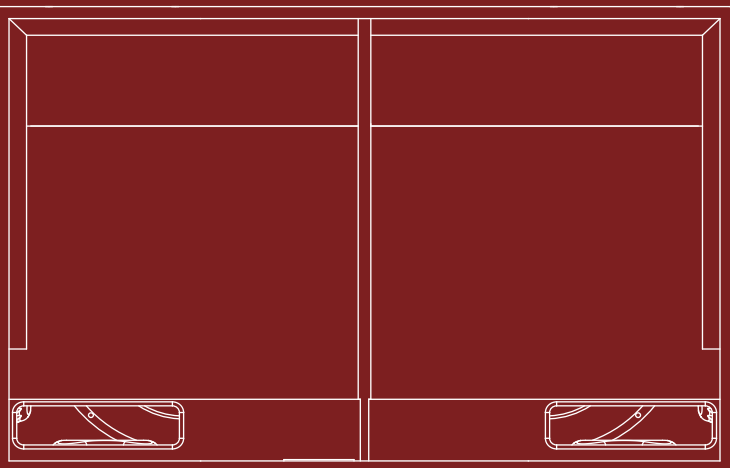
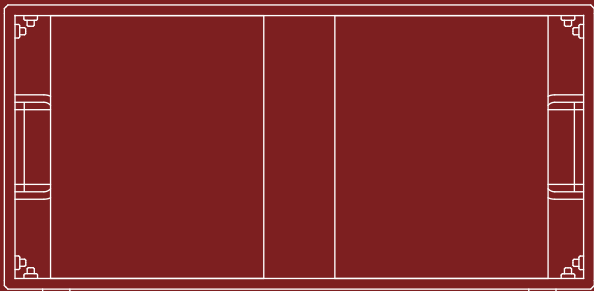

VS Series

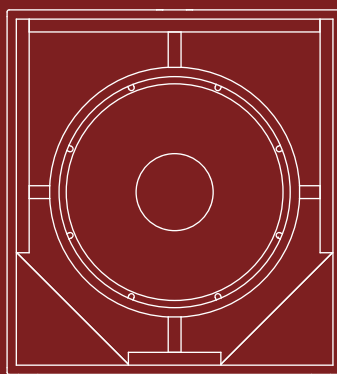

VSX Series

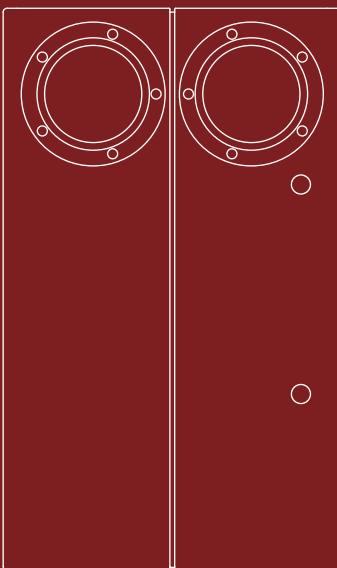

Subwoofers

While many Tannoy loudspeaker devices can deliver 'full-range' performance; for true low-frequency sound reinforcement, there's no substitute for dedicated subwoofer devices in any fixed-install or portable audio system. Designed specifically to provide far greater low-frequency extension than conventional 'full-range' loudspeakers, dedicated subwoofers can really make the difference between average or lack lustre audio reproduction and a high impact, high quality sonic experience.

Tannoy has developed a number of high performance subwoofer products for use in conjunction with the wide variety of loudspeaker devices, whether its in support of an in-ceiling or other distributed system, or to add presence and finesse to a high energy nightclub or bar sound reinforcement system - there's a subwoofer tailor made for the job.

With the recently introduced VSX Series, featuring the latest compact designs and technology, and the tried and tested large format twin driver VS Series enclosures, Tannoy has a comprehensive offering when it comes to delivering real bottom-end for any system.



When it comes to low end, we don't do sub-standard

Developed from the ground up, VSX Series is precision engineered to deliver high impact, low and ultra-low frequency reinforcement in a compact format. Powerful and versatile performers in either installed sound or portable / live PA applications, VSX Series is ideal for providing high definition, extended low-end response for Tannoy's wide range of installation loudspeaker systems.

All models feature a compact volume and footprint relative to their driver complement and performance capabilities, with each one optimised for maximum efficiency. This makes VSX Series well suited for applications where deep and powerful bass output has to be packed into dimensionally tight spaces.

All models boast a rugged and durable birch ply enclosure, with ergonomic Integrip carry handles and integrated, recessed termination panels with NL4 speakON and barrier strip connections for ease-of-install (speakON connectors are angled and recessed into the cabinet, allowing for flush-mounting to a wall, floor or ceiling irrespective of connection).

VSX SERIES AT A GLANCE

Model	Frequency Range (-10 dB)	Sensitivity	Rated SPL (avg.)	Recommended amplifier power	Dimensions (H x W x D)
VSX 10BP	36 Hz - 130 Hz	93 dB	116 dB	400 W @ 8 ohms	300 x 460 x 590 mm
VSX 8.2BP	38 Hz - 200 Hz	97 dB	123 dB	800 W @ 8 ohms	300 x 725 x 450 mm
VSX 12.2BP	35 Hz - 200 Hz	100 dB	129 dB	1600 W @ 4 ohms	400 x 830 x 720 mm
VSX 15DR	36 Hz - 4 kHz	97 dB	126 dB	1600 W @ 4 ohms	508 x 580 x 580 mm
VSX 18DR	32 Hz - 4 kHz	99 dB	129 dB	2000 W @ 8 ohms	588 x 650 x 650 mm



SCAN FOR
PRODUCT DATA



Features

- 5 band-pass and direct-radiating configurations to cover multitude of applications
- New band-pass designs featuring EMT, for higher output, lower distortion and greater reliability
- New lower profile cabinet designs, packing more performance into less space
- Recessed Integrip handles for ease of handling
- Recessed termination panels for flush mounting of connectors and flexible installation positioning
- Multiple flying points for overhead installation applications
- Recessed pole-mount locations for use in portable PA applications
- Weather protected options on selected models
- Custom colour finishes available for aesthetic integration

Applications

- Ballrooms and convention centres
- Bars & restaurants
- Corporate AV
- Houses of worship
- Live music & performance venues
- Nightclubs
- Museums & galleries
- Performing arts spaces
- Portable PA
- Retail spaces & malls
- Auditoria & lecture theatres

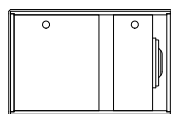

VSX 10BP

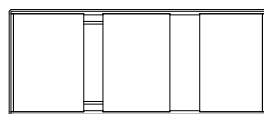

VSX 8.2BP

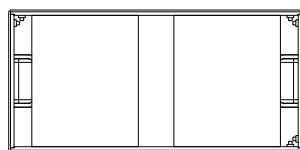

VSX 12.2BP

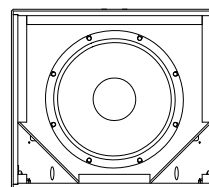

VSX 15DR

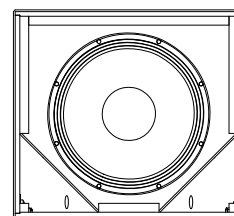

VSX 18DR



Move some serious air

The VS Subwoofer line offers systems designers and contractors the option of two large format enclosures designed to provide high SPL, ultra-low frequency sound reinforcement within fixed install and portable/live PA applications. Comprising twin 15" horn-loaded and twin 18" direct-radiating devices, each available in passive format or self-powered VNET variant with on-board DSP (networked), VS Subwoofers are well matched to partner Tannoy VQ Series systems. Additionally, these subwoofers can be deployed with larger VX and VXP Series full-range devices in systems where high impact sub-bass is required such as in high energy dance venues and bar/clubs.

The twin drivers in both the VS 215HL and VS 218DR (and VNET equivalents) are mounted in an immensely robust

cabinet, available in either black or white, which is constructed from 18 mm (5/8") multi-ply birch hardwood. This heavy-duty construction ensures it is able to survive the punishment that speaker systems are subjected to on the road and in club installations.

These large format subwoofer devices can be ground-stacked or flown – thanks to comprehensive complement of recessed carrying handles, M10 flying inserts and pull-back points. They can be deployed in cardioid array or end-firing configurations for specific applications where degrees of directivity and optimal performance are required.

Features

- High performance LF transducers
- Rigid enclosure delivers deep and powerful bass
- Compact, versatile enclosure
- High power handling
- High efficiency and low distortion
- Rugged birch plywood construction
- Convenient aspect ratio
- Recessed carry handles
- Integral flying points

Applications

- Ballrooms & convention centres
- Bars & Restaurants
- Corporate AV
- Houses of worship
- Live music & performance venues
- Nightclubs
- Museums & galleries
- Performing arts spaces
- Portable PA
- Retail spaces & malls
- Auditoria & lecture theatres



SCAN FOR
PRODUCT DATA



VS / VNET SERIES AT A GLANCE

Model	Frequency Range (-10dB)	Sensitivity	Rated SPL (avg.)	Rated power	Dimensions (H x W x D)
VS 215HL	40 Hz - 450 Hz	109 dB	142 dB	2000 W @ 8 ohms 4000 W @ 4 ohms	700 x 1050 x 850 mm
VS 218DR	24 Hz - 1.5 kHz	106 dB	139 dB	2000 W @ 8 ohms 4000 W @ 4 ohms	700 x 1050 x 850 mm
VNET 215HL	40 Hz - 450 Hz	-	140 dB	2500 W	700 x 1050 x 850 mm
VNET 218DR	24 Hz - 1.5 kHz	-	137 dB	2500 W	700 x 1050 x 850 mm

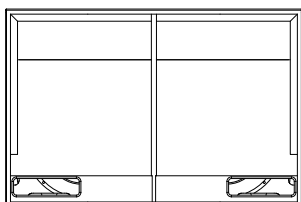

VS 215HL

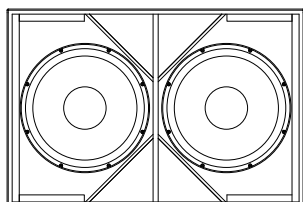

VS 218DR

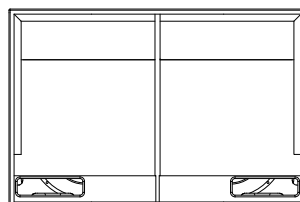

VNET 215HL

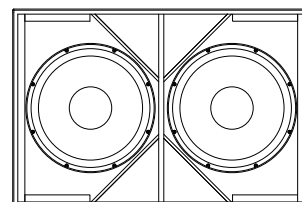

VNET 218DR

Tannoypro.com

Dedicated online resource

With a cutting edge, contemporary design in keeping with the ethos of Tannoy Professional, a new dedicated website presents our expansive product portfolio alongside a wealth of technical data and resources, making it easier than ever to specify and install Tannoy loudspeaker systems.

Tannoypro.com has been custom designed to give you a more intuitive and immersive experience than ever before. Intuitive navigation and logical organisation of products makes it easy to locate the desired information quickly - be it general product overview or specific technical resources including CAD files, EASE & CLF data, Software or detailed performance specification.

Recently launched ranges now benefit from a new 360 degree rotating viewer, giving you the opportunity to see the products from every angle, with grille on or off, giving a better feel for the fit and finish.

Extensive reference projects for each product are also easily accessible within this new portal, meaning a comprehensive and efficient package of resources and references for every single product line is on hand, when you need, where you need it. These Case Studies show our products in almost any application and give you the opportunity to see objective evaluation of any given product, especially important in light of some recent innovations in professional loudspeaker development such as digital beam-steering and software optimisation and modelling.



Scan the codes: Technical data at your fingertips

Using the QR codes on each product spread within this catalogue, you can easily link directly to the detailed product data on Tannoypro.com using your smartphone - with access to individual model data including PDF Data Sheets and other technical downloads. All you need is a QR code reader app installed on your mobile device, many of which exist on both Android and iOS. Simply scan the relevant code and you'll be taken to the respective product pages on Tannoypro.com where you can view or download additional detailed data. Of course, all of that data can be accessed directly on the website via desktop, laptop or tablet - our aim is to make it as simple as possible to work with Tannoy loudspeaker products.



Trademarks

The Tannoy brand was first trademarked on 10th March 1932, on which date the Tulsemere Manufacturing Company was formally registered as Guy R. Fountain Limited.

Tannoy, the Tannoy logo device, the Tannoy Professional logo device and all Tannoy product names and slogans are trademarks or registered trademarks of Tannoy Limited. BeamEngine, Dual Concentric, Focused Asymmetric Shaping Technology (FAST), Inductive Coupling Technology (ICT), Integrip, Point-Source Waveguide (PSW), PowerDual, SuperTweeter, VNET, are all trademarks of Tannoy Limited. Class D amplification with on-board DSP – all fully networkable - allowing for remote system commissioning, optimisation and real-time diagnostics of an installed sound system, via standard Ethernet network. The VNET software suite is available to download from at tannoypro.com and runs on any Windows PC or tablet.

Constant Innovation :

Latest Products

At Tannoy nothing stands still. Our engineering team and product specialists are always engaged in the pursuit of new and innovative loudspeaker products, each designed to meet specific market demands - and improve on what we already offer.

This Full Line Catalogue is just a snapshot in time of our current range of professional loudspeaker products, but you can keep it bang up-to-date by downloading the latest product data sheets and other detailed documentation for new products from the website at tannoypro.com. See the page opposite for more information.

tannoypro.com

Subwoofers

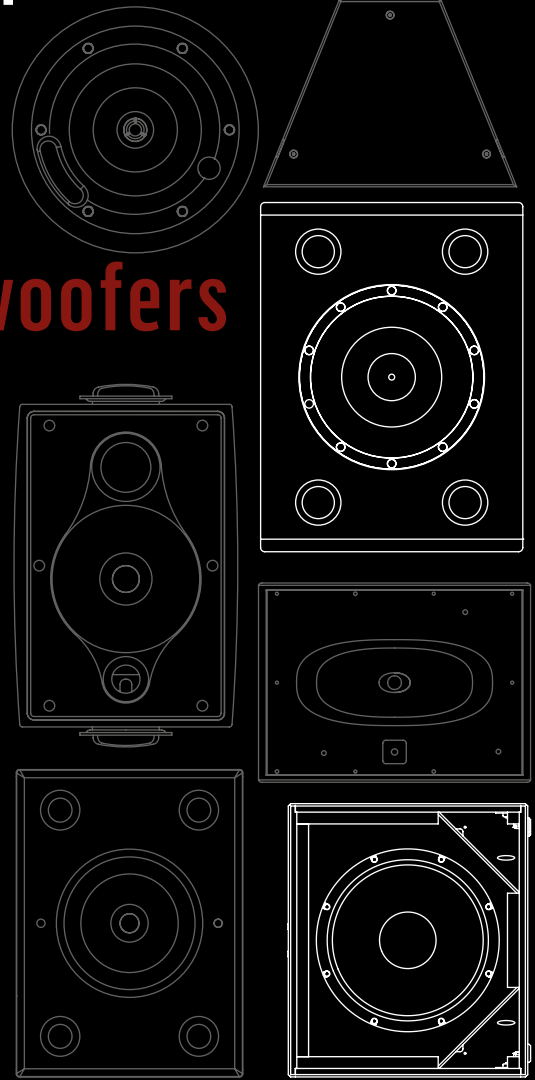

Commercial Install

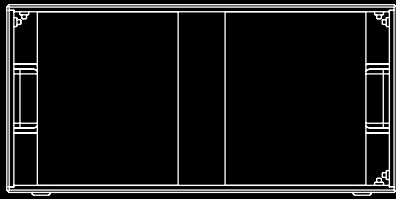

Live / Portable AV

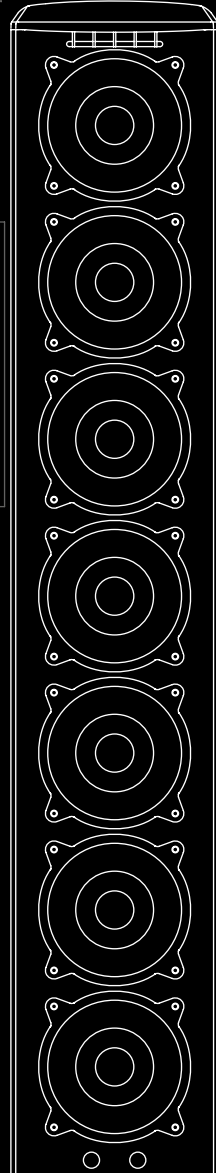

Performance Install

