



## SINGLE DIAPHRAGM CONDENSER MICROPHONE B-1

Gold-Sputtered Large-Diaphragm Studio Condenser Microphone

**EN Important Safety Instructions**

 Terminals marked with this symbol carry electrical current of sufficient magnitude to constitute risk of electric shock. Use only high-quality professional speaker cables with ¼" TS or twist-locking plugs pre-installed. All other installation or modification should be performed only by qualified personnel.

 This symbol, wherever it appears, alerts you to the presence of uninsulated dangerous voltage inside the enclosure - voltage that may be sufficient to constitute a risk of shock.

 This symbol, wherever it appears, alerts you to important operating and maintenance instructions in the accompanying literature. Please read the manual.

 **Caution**  
To reduce the risk of electric shock, do not remove the top cover (or the rear section). No user serviceable parts inside. Refer servicing to qualified personnel.

 **Caution**  
To reduce the risk of fire or electric shock, do not expose this appliance to rain and moisture. The apparatus shall not be exposed to dripping or splashing liquids and no objects filled with liquids, such as vases, shall be placed on the apparatus.

 **Caution**  
These service instructions are for use by qualified service personnel only. To reduce the risk of electric shock do not perform any servicing other than that contained in the operation instructions. Repairs have to be performed by qualified service personnel.

1. Read these instructions.
2. Keep these instructions.
3. Heed all warnings.
4. Follow all instructions.
5. Do not use this apparatus near water.
6. Clean only with dry cloth.
7. Do not block any ventilation openings. Install in accordance with the manufacturer's instructions.
8. Do not install near any heat sources such as radiators, heat registers, stoves, or other apparatus (including amplifiers) that produce heat.
9. Do not defeat the safety purpose of the polarized or grounding-type plug. A polarized plug has two blades with one wider than the other. A grounding-type plug has two blades and a third grounding prong. The wide blade or the third prong are provided for your safety. If the provided plug does not fit into your outlet, consult an electrician for replacement of the obsolete outlet.
10. Protect the power cord from being walked on or pinched particularly at plugs, convenience receptacles, and the point where they exit from the apparatus.
11. Use only attachments/accessories specified by the manufacturer.



12. Use only with the cart, stand, tripod, bracket, or table specified by the manufacturer, or sold with the apparatus. When a cart is used, use caution when moving the cart/apparatus combination to avoid injury from tip-over.

13. Unplug this apparatus during lightning storms or when unused for long periods of time.
14. Refer all servicing to qualified service personnel. Servicing is required when the apparatus has been damaged in any way, such as power supply cord or plug is damaged, liquid has been spilled or objects have fallen into the apparatus, the apparatus has been exposed to rain

or moisture, does not operate normally, or has been dropped.

15. The apparatus shall be connected to a MAINS socket outlet with a protective earthing connection.

16. Where the MAINS plug or an appliance coupler is used as the disconnect device, the disconnect device shall remain readily operable.

 17. Correct disposal of this product: This symbol indicates that this product must not be disposed of with household waste,

according to the WEEE Directive (2012/19/EU) and your national law. This product should be taken to a collection center licensed for the recycling of waste electrical and electronic equipment (EEE). The mishandling of this type of waste could have a possible negative impact on the environment and human health due to potentially hazardous substances that are generally associated with EEE. At the same time, your cooperation in the correct disposal of this product will contribute to the efficient use of natural resources. For more information about where you can take your waste equipment for recycling, please contact your local city office, or your household waste collection service.

18. Do not install in a confined space, such as a book case or similar unit.

19. Do not place naked flame sources, such as lighted candles, on the apparatus.

20. Please keep the environmental aspects of battery disposal in mind. Batteries must be disposed-of at a battery collection point.

21. Use this apparatus in tropical and/or moderate climates.

**LEGAL DISCLAIMER**

MUSIC Tribe accepts no liability for any loss which may be suffered by any person who relies either wholly or in part upon any description, photograph, or statement contained herein.

Technical specifications, appearances and other information are subject to change without notice. All trademarks are the property of their respective owners. MIDAS, KLARK TEKNIK, LAB GRUPPEN, LAKE, TANNÖY, TURBOSOUND, TC ELECTRONIC, TC HELICON, BEHRINGER, BUGERA and COOLAUDIO are trademarks or registered trademarks of MUSIC Tribe Global Brands Ltd. © MUSIC Tribe Global Brands Ltd. 2018 All rights reserved.

**LIMITED WARRANTY**

For the applicable warranty terms and conditions and additional information regarding MUSIC Tribe's Limited Warranty, please see complete details online at [musictri.be/warranty](http://musictri.be/warranty).

## 1. Power Supply

Your condenser mic B-1 needs a +48-V phantom power supply. Behringer assumes no liability for any damage caused by a defective phantom power supply. Always mute the sound reinforcement system before you switch on the phantom power supply. After power-up, the B-1 needs about 6 seconds to stabilize.

## 2. Directivity, Low-Cut Filter and Level Attenuation

The capsule used in the B-1 with cardioid characteristics is ideal for the directional recording of instruments or individual vocals. Cardioid characteristics represent the most frequently used polar pattern in recording situations. With this, unwanted sound in reverse phase is not picked up.

The low-cut filter can be activated with the switch on the front (position: left), in order to filter low-frequency interference such as pop sounds, etc. With the low-cut filter on, the B-1 provides an almost linear frequency response with signals picked up at close proximity to the source. The built-in shielding minimizes the microphone's sensitivity to high-frequency interference.

Use the same switch to activate the -10 dB level attenuator (position: right), which should be used with "pulse-type" signal sources producing high sound pressure levels (e.g. kick drum). With the switch set to its center position, both functions are disabled.

## 3. Mounting Microphone and Elastic Suspension

Attach the enclosed elastic suspension to the microphone stand. Fasten the screw, once the suspension has been positioned properly. Open the elastic suspension by pressing the two circular levers, then insert the B-1 from above.

## 4. Audio Connection/Level Setting

Use a balanced XLR microphone cable with the following pin assignment: pin 1 = shielding; pin 2 = +; pin 3 = -. Since your B-1 features gold-plated contact points throughout, we recommend that you use only microphone cables with gold-plated connectors.

Adjust the gain control in the microphone channel of your mixing console so that the peak LED lights up only occasionally or never at all. The EQ controls in the microphone channel should be set to mid-travel position to start with; low-cut filter and level attenuator should be off. Try to achieve the desired sound by experimenting with the microphone position. Often, it will be useful to set up acoustic barriers ("gobos") at various angles towards the signal source. Only when the desired basic sound has been achieved, should you start to use equalizers and signal processors, if any at all (Remember: less is often more!)

The B-1 provides a level peak around 12 kHz producing some kind of "presence" in this range; so, there is no need for high-frequency EQing which could deteriorate the signal and raise the overall noise floor. On the contrary, the B-1 provides that much-desired transparency which often gets lost during recording and mixing.

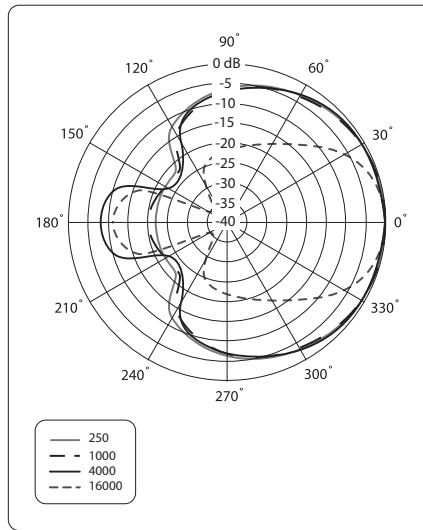

Polar pattern

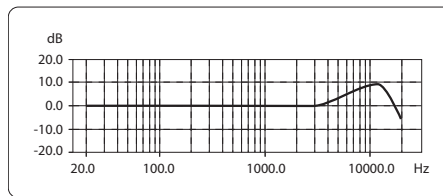

Frequency response

## 5. Specifications

Transducer type	condenser, 1" single diaphragm
Operating principle	pressure gradient
Polar pattern	cardioid
Connection	gold-plated balanced XLR connector
Open circuit voltage at 1 kHz	-34 +/-2 dBV (0 dBV = 1 V/Pa)
Open circuit sensitivity	20 mV/Pa
Frequency range	20 Hz - 20 kHz
Level attenuation	-10 dB (switchable)
Low-Cut filter	6 dB/Octave at 75 Hz (switchable)
Max. SPL (1% THD @ 1 kHz)	138 dB (0 dB), 148 dB (-10 dB)
Equivalent SPL (IEC 268-4)	13 dB-A
Signal-to-noise ratio re 1 Pa	81 dB A-weighted
Nominal impedance	50 Ω
Load impedance >	1 kΩ

### Mains Voltage/Fuse

Supply voltage	+48 V
Supply current	3 mA

### Physical/Weight

Dimensions	0: 58 mm, length: 174 mm
Weight	0,461 kg

We Hear You