

Touring

LIVERPOOL TLX84

Dual 2 Way 8" Line Array Element for
Portable and Fixed Installation Applications



- 2 way line array element for portable and fixed installation application
- 450 Watts continuous, 1,800 Watts peak power
- Ideal for FOH, center cluster, offstage fill, stereo in-fill or distributed fill applications
- Dual 8" low frequency drivers with weather resistant cones
- Dual titanium dome 1" copper clad aluminium coil compression driver
- Integral rigging system for suspending or ground stacking multiple TLX84 elements
- Wide 100° H x 10° V dispersion for even coverage
- Bi-amp operation for high output and controlled dispersion
- 15 mm (5/8") birch plywood enclosure with hard wearing semi matt black paint finish
- Powder coated perforated steel mesh grille
- Neutrik speakON* NL4 connectors for reliable long life operation
- Compatible with TLX215L dual 15" subwoofer
- 10-Year Warranty Program*
- Designed and engineered in the U.K.

The 2-way full range TLX84 is a compact bi-amplified dual 8" 1,800-Watt line array element that is ideally suited to a broad range of speech and music sound reinforcement applications in fixed installation, portable and touring audio systems. The TLX84 is designed to work in conjunction with LAKE DSP and LAB GRUPPEN amplification, providing optimal FOH performance, as well as offering considerable flexibility to readily adapt to varying venue requirements.

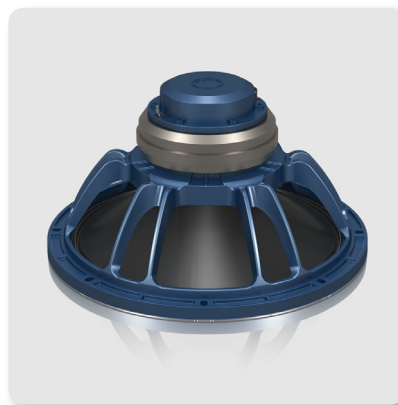

100° horizontal by 10° vertical dispersion pattern, the TLX84 provides exceptional coverage in wide rooms and in distributed fill applications.

Custom-Engineered Drivers

TURBOSOUND is recognised the world over for designing and building some of the most iconic loudspeakers and subwoofers. We take meticulous care and pride in maintaining that reputation by utilising only drivers designed specifically for each application – it's what sets us apart from the competition.

Featuring two 8" low frequency drivers with weather resistant cones and two 1" titanium dome copper clad aluminium coil compression drivers, the TLX84 delivers unparalleled clarity and intelligibility in a compact enclosure that belies its impressive performance. Due to its broad

Touring

LIVERPOOL TLX84

Dual 2 Way 8" Line Array Element for
Portable and Fixed Installation Applications

Construction and Connectivity

An integral suspension system engineered to meet BGV-C1 specifications is provided for suspending or ground stacking multiple TLX84 elements with a 10:1 safety factor. Designed for speed and simplicity of use, custom-engineered flybars and road cases are available as separate accessories. The companion TLX215L dual 15" subwoofer is specifically designed for use with TLX84, providing additional low frequency extension and substantial impact for more demanding sound reinforcement applications. Finished in hard wearing semi matt black paint, the cabinet is constructed from 15 mm ($\frac{5}{8}$ ") birch plywood and includes a rugged powder coated perforated steel mesh grille backed with reticulated foam. The rear panel connector plate carries Neutrik speakON* NL4 connectors for input and link connections to additional enclosures.

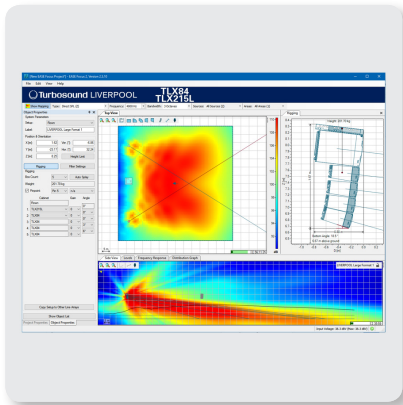

Acoustic Simulation Tools

EASE GLL files are provided for EASE Focus Acoustic Simulation Software, which is available for free download. This allows accurate calculation of both acoustic coverage and suspension pick point selection for tilting and aiming the array at the desired angle.

You Are Covered

We always strive to provide the best possible Customer Experience. Our products are made in our own MUSIC Tribe factory using state-of-the-art automation, enhanced production workflows and quality assurance labs with the most sophisticated test equipment available in the world. As a result, we have one of the lowest product failure rates in the industry, and we confidently back it up with a generous Warranty program.



Touring

LIVERPOOL

TLX84

Dual 2 Way 8" Line Array Element for Portable and Fixed Installation Applications

Frequency Response Sensitivity 1 W / 1 m

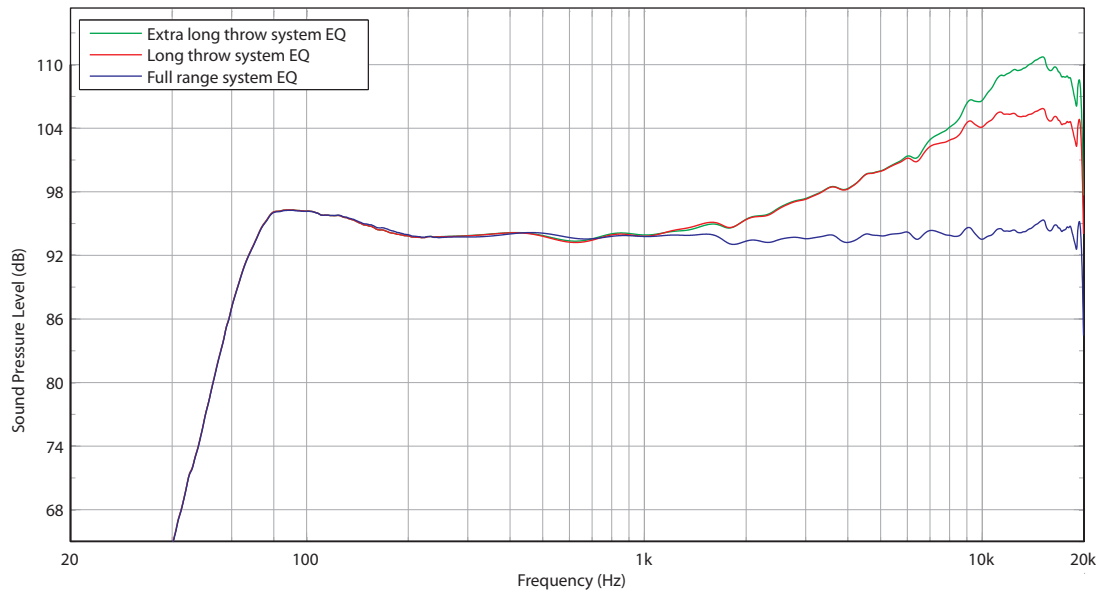

Impedance

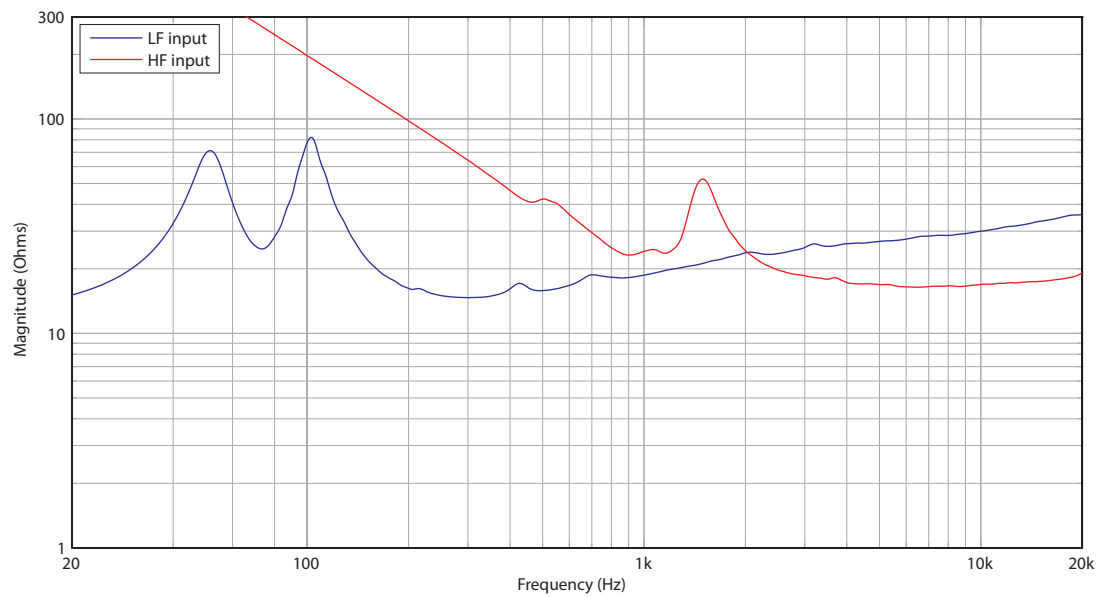

Touring

LIVERPOOL

TLX84

Dual 2 Way 8" Line Array Element for Portable and Fixed Installation Applications

Horizontal Beamwidth

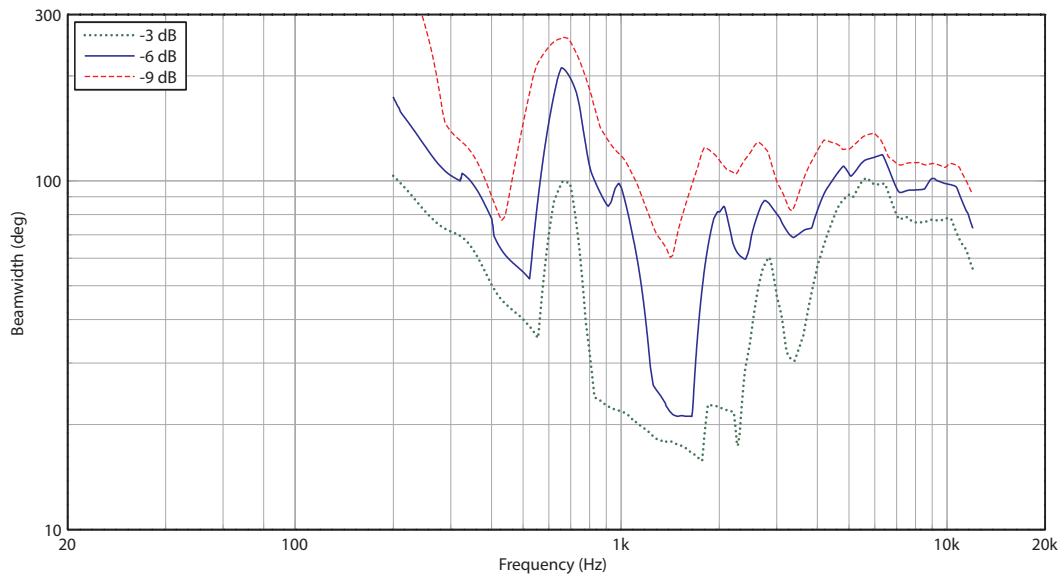

Vertical Beamwidth

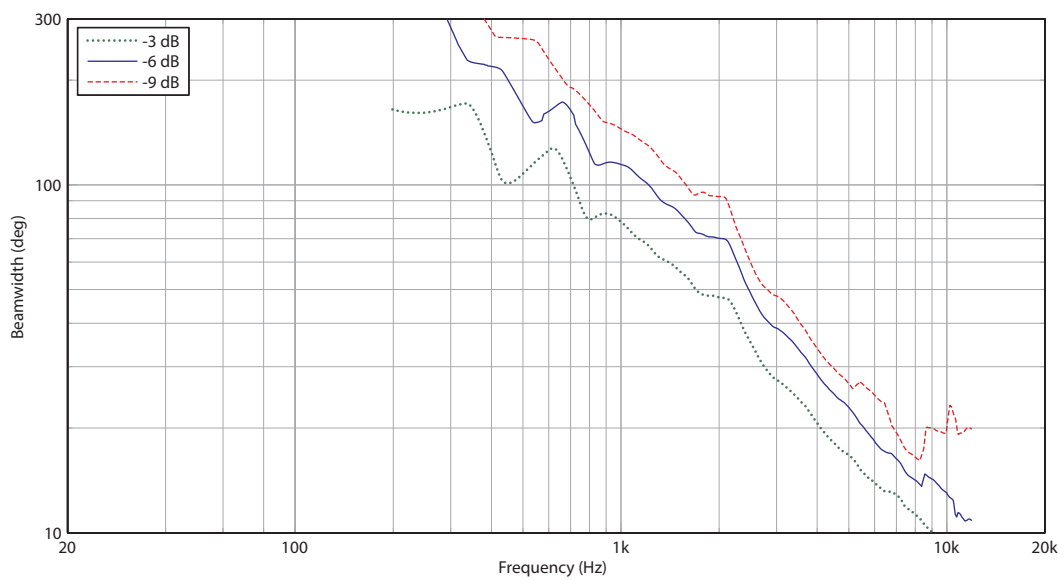

Touring

LIVERPOOL

TLX84

Dual 2 Way 8" Line Array Element for
Portable and Fixed Installation Applications

Horizontal Polar Plots

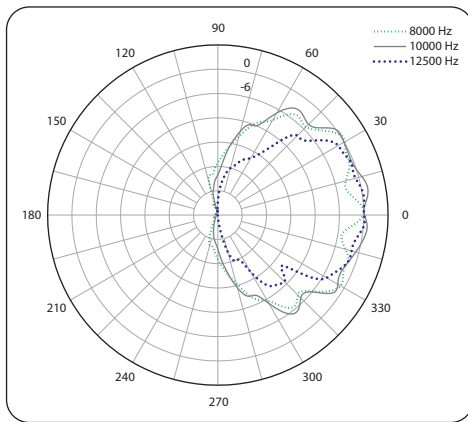
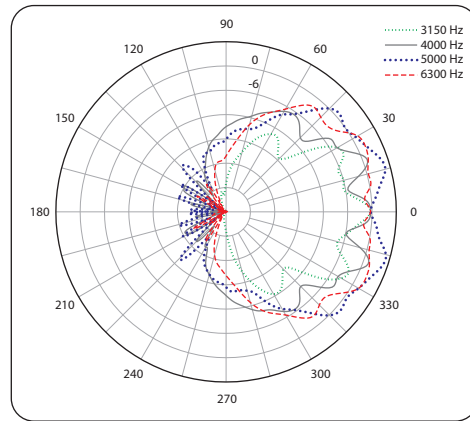
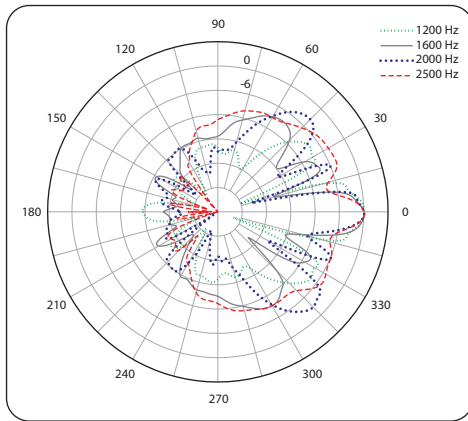
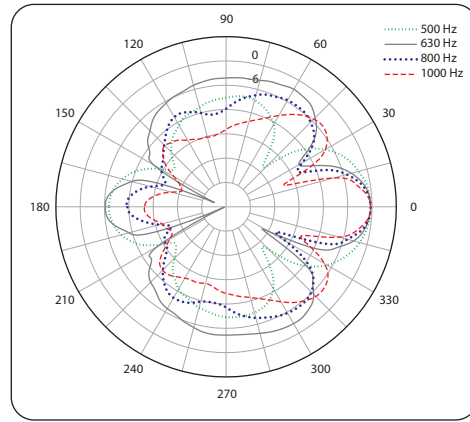
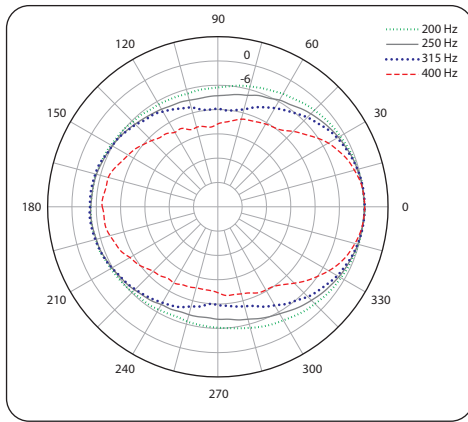

Touring

LIVERPOOL

TLX84

Dual 2 Way 8" Line Array Element for
Portable and Fixed Installation Applications

Vertical Polar Plots

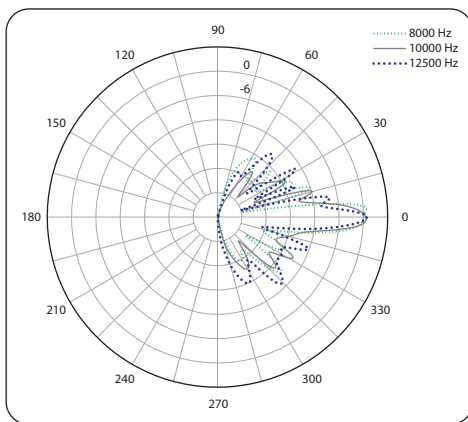
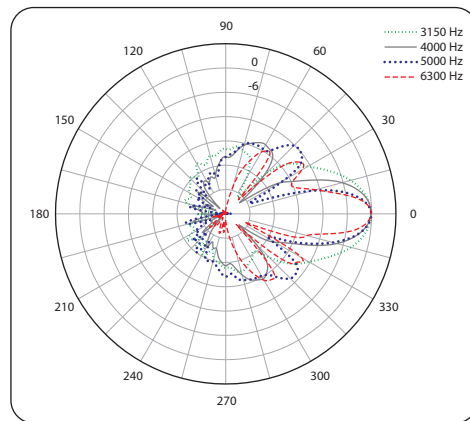
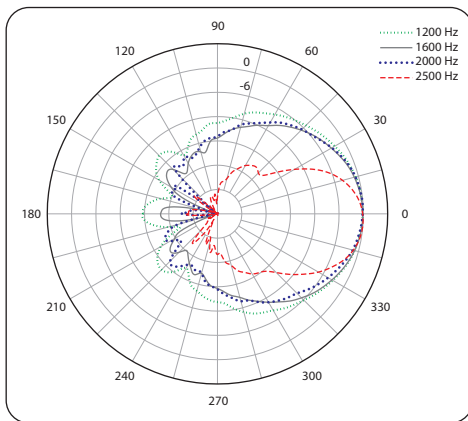
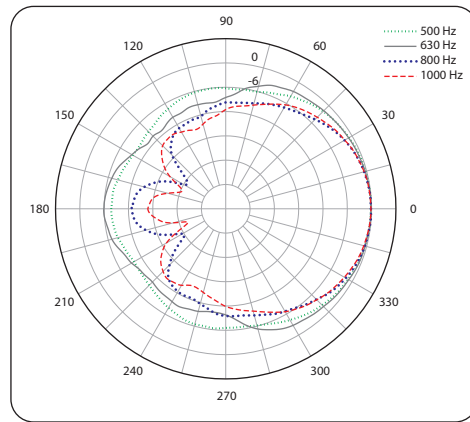
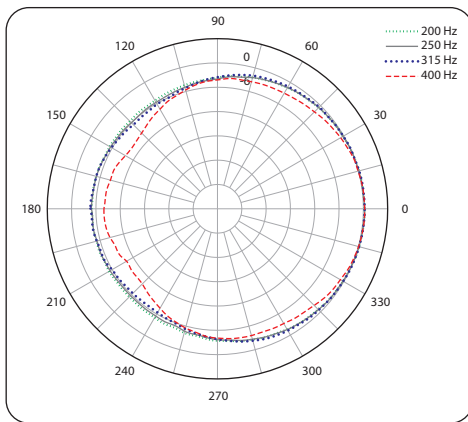

Touring

LIVERPOOL

TLX84

Dual 2 Way 8" Line Array Element for
Portable and Fixed Installation Applications

Dimensions

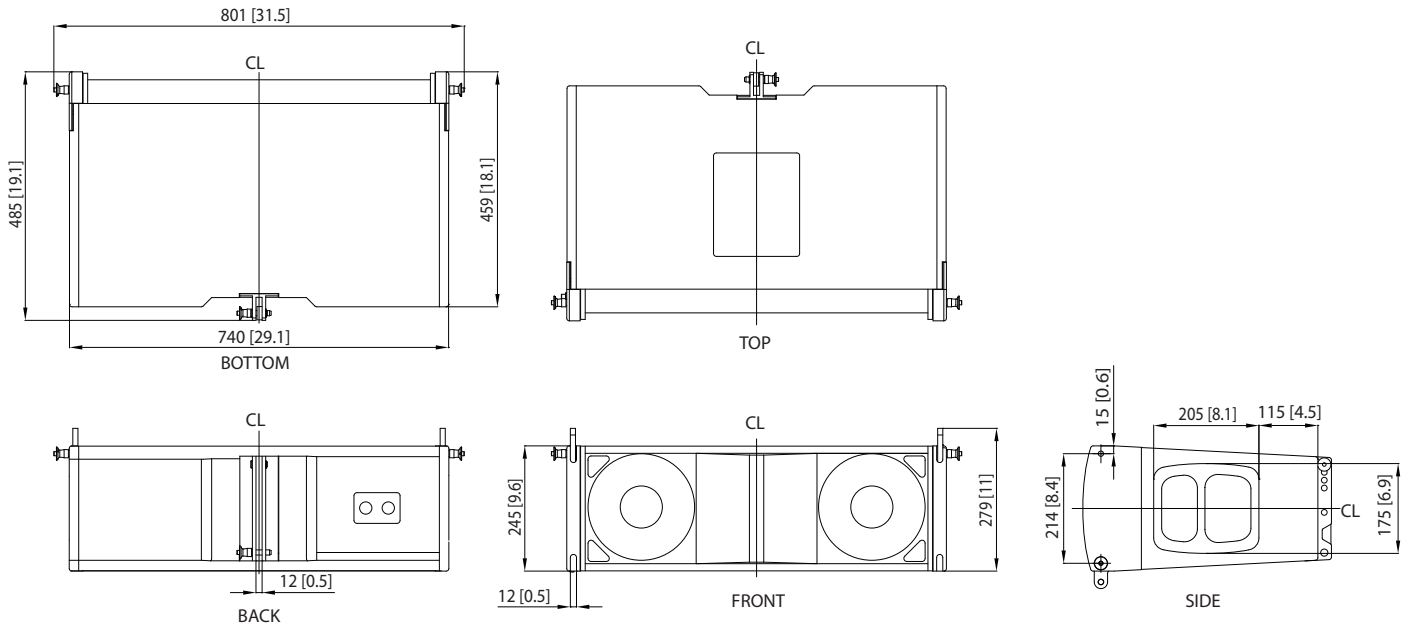

Touring

LIVERPOOL

TLX84

Dual 2 Way 8" Line Array Element for Portable and Fixed Installation Applications

Mounting and Rigging

! Safety Warning: Only authorised and certified personnel shall design and install suspended or ground stack configurations, following the instructions and procedures in the TLX84-FLB rigging manual supplied with the TLX84-FLB flybar, or downloaded from turbosound.com. Failure to follow these instructions may lead to death or permanent injury. For maximum array sizes, weights and working load limits, please consult the TLX84-FLB rigging manual.

The TLX84 cabinet has drop down mounting links on the bottom, and slots and mounting holes on the top. The various mounting points allow the TLX84-FLB flybar to be attached to the top of the TLX84 cabinet, and allows TLX84 cabinets to be joined together, and connected above or below the TLX215L subwoofer. The angle of the TLX84 cabinet can be varied by choosing 1 of 7 rear mounting holes to select 0 to 6 degree inter-cabinet angles in 1 degree increments. Rigging pins are provided to secure the TLX84 cabinets, TLX215L subwoofer, and TLX84-FLB flybar together.

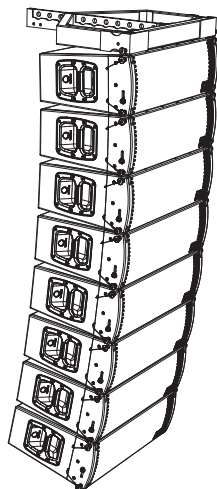
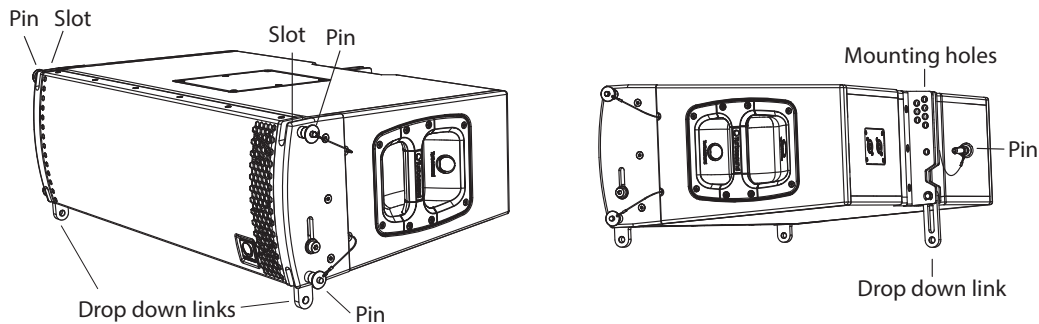

An array of 8 TLX84 cabinets attached to a TLX84-FLB flybar

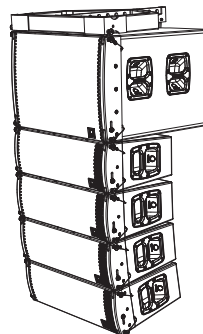

Mixed array with a TLX84-FLB flybar, TLX215L subwoofer, and 4 TLX84 cabinets

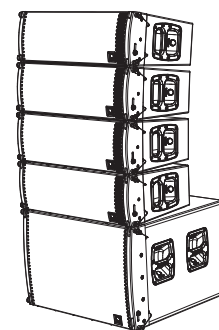

Mixed array ground stack with a TLX215L subwoofer, and 4 TLX84 cabinets

Touring

LIVERPOOL TLX84

Dual 2 Way 8" Line Array Element for
Portable and Fixed Installation Applications

Technical Specifications

System

Frequency Response	67 Hz – 20 kHz \pm 3 dB 58 Hz – 20 kHz -10 dB
Nominal Dispersion	100° H x 10° V @ -6 dB points
Power Handling (IEC)	LF: 450 W continuous, 1,800 W peak HF: 60 W continuous, 240 W peak
Sensitivity	LF: 94 dB (1 W @ 1 m) HF: 101 dB (1 W @ 1 m)
Maximum SPL	LF: 121 dB continuous, 127 dB peak HF: 119 dB continuous, 125 dB peak
Impedance	LF: 16 Ω HF: 16 Ω
Crossover Type	External bi-amp
Components	2 x 8" (203 mm) LF driver 2 x 1" (25.4 mm) HF compression driver

Enclosure

Connectors	2 x Neutrik speakON* NL4
Wiring	Pins 1+ / 1- LF, pins 2+ / 2- HF
Dimensions H x W x D	245 x 801 x 485 mm (9.6 x 31.5 x 19.1")
Net Weight	27.9 kg (61.4 lbs)
Construction	15 mm (5/8") plywood
Finish	Semi matt black paint
Grille	Powder coated perforated steel
Suspension Hardware	Integral variable curvature

Accessories

TLX84-FLB fly bar
TLX84-RC4 road case

Touring

LIVERPOOL

TLX84

Dual 2 Way 8" Line Array Element for
Portable and Fixed Installation Applications

Architecture & Engineering Specifications

The loudspeaker shall be of the two-way bi-amp passive type consisting of two 8" (203 mm) LF drivers and two 1" (25.4 mm) HF compression drivers. Performance specifications of a typical production unit shall meet or exceed the following: frequency response, measured with swept sine wave input, shall be flat within ± 3 dB from 67 Hz to 20 kHz and within -10 dB from 58 Hz to 20 kHz. Nominal dispersion, at -6 dB points, shall average 100° H x 10° V. Nominal impedance shall be HF: 16 Ohms, LF: 16 Ohms. Power handling shall be HF: 60 Watts continuous, 240 Watts peak, LF: 450 Watts continuous, 1,800 Watts peak. Sensitivity, measured on axis, mean averaged over the stated bandwidth, shall be HF: 101 dB, 1 Watt @ 1 metre, LF: 94 dB, 1 Watt @ 1 metre. Maximum SPL (peak), measured at 1 metre with music program at stated amplifier input, shall be HF: 125 dB, LF: 127 dB. Dimensions: 245 mm high x 801 mm wide x 485 mm deep (9.6" x 31.5" x 19.1"). Net weight: 27.9 kg (61.4 lbs). The loudspeaker system shall be the [TURBOSOUND TLX84](#). No other loudspeaker shall be acceptable unless submitted data from an independent test laboratory verifies that the above combined performance / size specifications are equaled or exceeded.

Touring

LIVERPOOL

TLX84

Dual 2 Way 8" Line Array Element for
Portable and Fixed Installation Applications

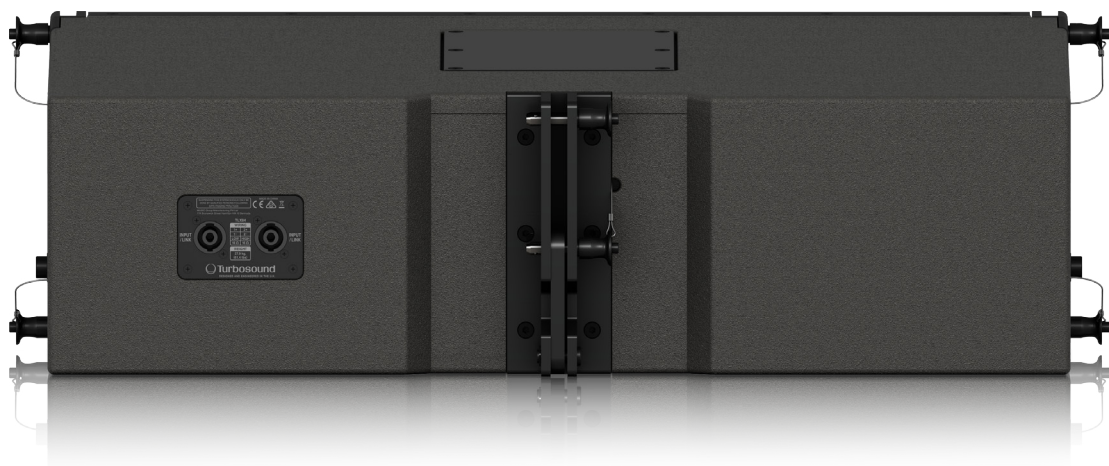

Touring

LIVERPOOL

TLX84

Dual 2 Way 8" Line Array Element for
Portable and Fixed Installation Applications



Touring

LIVERPOOL TLX84

Dual 2 Way 8" Line Array Element for
Portable and Fixed Installation Applications



For service, support or more information contact the TURBOSOUND location nearest you:

Europe
MUSIC Tribe Brands UK Ltd.
 Tel: +44156 273 2290
 Email: CARECrea@music-group.com
 CAREEnte@music-group.com
 CARELife@music-group.com

USA/Canada
MUSIC Tribe Commercial NV Inc.
 Tel: +1 702.800 8290
 Email: CARECrea@music-group.com
 CAREEnte@music-group.com
 CARELife@music-group.com

Japan
MUSIC Tribe Services JP K.K.
 Tel: +81 3 6231 0453
 Email: CARECrea@music-group.com
 CAREEnte@music-group.com
 CARELife@music-group.com

MUSIC Tribe accepts no liability for any loss which may be suffered by any person who relies either wholly or in part upon any description, photograph, or statement contained herein. Technical specifications, appearances and other information are subject to change without notice. All trademarks are the property of their respective owners. MIDAS, KLARK TEKNIK, LAB GRUPPEN, LAKE, TANNØY, TURBOSOUND, TC ELECTRONIC, TC HELICON, BEHRINGER, BUGERA and COOLAUDIO are trademarks or registered trademarks of MUSIC Group IP Ltd.
 © MUSIC Group IP Ltd. 2018 All rights reserved.

