



TLX LIVERPOOL SERIES

TLX215L/TLX212L

Compact Dual 15"/ 12" Subwoofer for Portable and Fixed Installation Applications

TLX84

Dual 2 Way 8" Line Array Element for Portable and Fixed Installation Applications

TLX43

Compact Dual 2 Way 4" Line Array Element for Portable and Fixed Installation Applications

Quick Start Guide



EN

EN Important Safety Instructions

Terminals marked with this symbol carry electrical current of sufficient magnitude to constitute risk of electric shock.

Use only high-quality professional speaker cables with ¼" TS or twist-locking plugs pre-installed. All other installation or modification should be performed only by qualified personnel.



This symbol, wherever it appears, alerts you to the presence of uninsulated dangerous voltage inside the enclosure - voltage that may be sufficient to constitute a risk of shock.



This symbol, wherever it appears, alerts you to important operating and maintenance instructions in the accompanying literature. Please read the manual.

**Caution**

To reduce the risk of electric shock, do not remove the top cover (or the rear section). No user serviceable parts inside. Refer servicing to qualified personnel.

**Caution**

To reduce the risk of fire or electric shock, do not expose this appliance to rain and moisture. The apparatus shall not be exposed to dripping or splashing liquids and no objects filled with liquids, such as vases, shall be placed on the apparatus.

**Caution**

These service instructions are for use by qualified service personnel only. To reduce the risk of electric shock do not perform any servicing other than that contained in the operation instructions. Repairs have to be performed by qualified service personnel.

1. Read these instructions.
2. Keep these instructions.
3. Heed all warnings.
4. Follow all instructions.
5. Do not use this apparatus near water.
6. Clean only with dry cloth.
7. Do not block any ventilation openings. Install in accordance with the manufacturer's instructions.
8. Do not install near any heat sources such as radiators, heat registers, stoves, or other apparatus (including amplifiers) that produce heat.

9. Do not defeat the safety purpose of the polarized or grounding-type plug. A polarized plug has two blades with one wider than the other. A grounding-type plug has two blades and a third grounding prong. The wide blade or the third prong are provided for your safety. If the provided plug does not fit into your outlet, consult an electrician for replacement of the obsolete outlet.

10. Protect the power cord from being walked on or pinched particularly at plugs, convenience receptacles, and the point where they exit from the apparatus.

11. Use only attachments/accessories specified by the manufacturer.



12. Use only with the cart, stand, tripod, bracket, or table specified by the manufacturer, or sold with the apparatus. When a cart is used, use caution when moving the cart/apparatus combination to avoid

injury from tip-over.

13. Unplug this apparatus during lightning storms or when unused for long periods of time.

14. Refer all servicing to qualified service personnel. Servicing is required when the apparatus has been damaged in any way, such as power supply cord or plug is damaged, liquid has been spilled or objects have fallen into the apparatus, the apparatus has been exposed to rain or moisture, does not operate normally, or has been dropped.

15. The apparatus shall be connected to a MAINS socket outlet with a protective earthing connection.

16. Where the MAINS plug or an appliance coupler is used as the disconnect device, the disconnect device shall remain readily operable.



17. Correct disposal of this product: This symbol indicates that this product must not be disposed of with household waste, according to the WEEE Directive (2012/19/EU) and your national law. This product should be taken

to a collection center licensed for the recycling of waste electrical and electronic equipment (EEE). The mishandling of this type of waste could have a possible negative impact on the environment and human health due to potentially hazardous substances that are generally associated with EEE. At the same time, your cooperation in the correct disposal of this product will contribute to the efficient use of natural resources. For more information about where you can take your waste equipment for recycling, please contact your local city office, or your household waste collection service.

18. Do not install in a confined space, such as a book case or similar unit.

19. Do not place naked flame sources, such as lighted candles, on the apparatus.

20. Please keep the environmental aspects of battery disposal in mind. Batteries must be disposed of at a battery collection point.

21. Use this apparatus in tropical and/or moderate climates.

LEGAL DISCLAIMER

MUSIC Group accepts no liability for any loss which may be suffered by any person who relies either wholly or in part upon any description, photograph, or statement contained herein. Technical specifications, appearances and other information are subject to change without notice. All trademarks are the property of their respective owners. MIDAS, KLARK TEKNIK, LAB GRUPPEN, LAKE, TANNOY, TURBOSOUND, TC ELECTRONIC, TC HELICON, BEHRINGER, BUGERA and DDA are trademarks or registered trademarks of MUSIC Group IP Ltd. © MUSIC Group IP Ltd. 2017 All rights reserved.

LIMITED WARRANTY

For the applicable warranty terms and conditions and additional information regarding MUSIC Group's Limited Warranty, please see complete details online at music-group.com/warranty.

ES Instrucciones de seguridad

Las terminales marcadas con este símbolo transportan corriente eléctrica de magnitud suficiente como para constituir un riesgo de descarga eléctrica. Utilice solo cables de altavoz profesionales y de alta calidad con conectores TS de 6,3 mm o de bayoneta prefijados. Cualquier otra instalación o modificación debe ser realizada únicamente por un técnico cualificado.



Este símbolo, siempre que aparece, le advierte de la presencia de voltaje peligroso sin aislar dentro de la caja; este voltaje puede ser suficiente para constituir un riesgo de descarga.



Este símbolo, siempre que aparece, le advierte sobre instrucciones operativas y de mantenimiento que aparecen en la documentación adjunta. Por favor, lea el manual.

**Atención**

Para reducir el riesgo de descarga eléctrica, no quite la tapa (o la parte posterior). No hay piezas en el interior del equipo que puedan ser reparadas por el usuario. Si es necesario, póngase en contacto con personal cualificado.

**Atención**

Para reducir el riesgo de incendio o descarga eléctrica, no exponga este aparato a la lluvia, humedad o alguna otra fuente que pueda salpicar o derramar algún líquido sobre el aparato. No coloque ningún tipo de recipiente para líquidos sobre el aparato.

**Atención**

Las instrucciones de servicio deben llevarlas a cabo exclusivamente personal cualificado. Para evitar el riesgo de una descarga eléctrica, no realice reparaciones que no se encuentren descritas en el manual de operaciones. Las reparaciones deben ser realizadas exclusivamente por personal cualificado.

1. Lea las instrucciones.
2. Conserve estas instrucciones.
3. Preste atención a todas las advertencias.
4. Siga todas las instrucciones.
5. No use este aparato cerca del agua.
6. Limpie este aparato con un paño seco.
7. No bloquee las aberturas de ventilación. Instale el equipo de acuerdo con las instrucciones del fabricante.
8. No instale este equipo cerca de fuentes de calor tales como radiadores, acumuladores de calor, estufas u otros aparatos (incluyendo amplificadores) que puedan producir calor.

9. No elimine o deshabilite nunca la conexión a tierra del aparato o del cable de alimentación de corriente. Un enchufe polarizado tiene dos polos, uno de los cuales tiene un contacto más ancho que el otro. Una clavija con puesta a tierra dispone de tres contactos: dos polos y la puesta a tierra. El contacto ancho y el tercer contacto, respectivamente, son los que garantizan una mayor seguridad. Si el enchufe suministrado con el equipo no concuerda con la toma de corriente, consulte con un electricista para cambiar la toma de corriente obsoleta.

10. Coloque el cable de suministro de energía de manera que no pueda ser pisado y que esté protegido de objetos afilados. Asegúrese de que el cable de suministro de energía esté protegido, especialmente en la zona de la clavija y en el punto donde sale del aparato.

11. Use únicamente los dispositivos o accesorios especificados por el fabricante.



12. Use únicamente la carretilla, plataforma, trípode, soporte o mesa especificados por el fabricante o suministrados junto con el equipo. Al transportar el equipo, tenga cuidado para evitar

daños y caídas al tropezar con algún obstáculo.

13. Desenchufe el equipo durante tormentas o si no va a utilizarlo durante un periodo largo.

14. Confíe las reparaciones únicamente a servicios técnicos cualificados. La unidad requiere mantenimiento siempre que haya sufrido algún daño, si el cable de suministro de energía o el enchufe presentaran daños, se hubiera derramado un líquido o hubieran caído objetos dentro del equipo, si el aparato hubiera estado expuesto a la humedad o la lluvia, si ha dejado de funcionar de manera normal o si ha sufrido algún golpe o caída.

15. Al conectar la unidad a la toma de corriente eléctrica asegúrese de que la conexión disponga de una unión a tierra.

16. Si el enchufe o conector de red sirve como único medio de desconexión, éste debe ser accesible fácilmente.



17. Cómo debe deshacerse de este aparato: Este símbolo indica que este aparato no debe ser tratado como basura orgánica, según lo indicado en la Directiva WEEE (2012/19/EU) y a las normativas aplicables en su país.

En lugar de ello deberá llevarlo al punto limpio más cercano para el reciclaje de sus elementos eléctricos / electrónicos (EEE). Al hacer esto estará ayudando a prevenir las posibles consecuencias negativas para el medio ambiente y la salud que podrían ser provocadas por una gestión inadecuada de este tipo de aparatos. Además, el reciclaje de materiales ayudará a conservar los recursos naturales. Para más información acerca del reciclaje de este aparato, póngase en contacto con el Ayuntamiento de su ciudad o con el punto limpio local.

18. No instale esta unidad en un espacio muy reducido, tal como encastrada en una librería o similar.

19. No coloque objetos con llama, como una vela encendida, sobre este aparato.

20. Tenga presentes todas las advertencias relativas al reciclaje y correcta eliminación de las pilas. Las pilas deben ser siempre eliminadas en un punto limpio y nunca con el resto de la basura orgánica.

21. Use este aparato en rangos de temperatura moderados y/o tropicales.

NEGACIÓN LEGAL

MUSIC Group no admite ningún tipo de responsabilidad por cualquier daño o pérdida que pudiera sufrir cualquier persona por confiar total o parcialmente en la descripciones, fotografías o afirmaciones contenidas en este documento. Las especificaciones técnicas, imágenes y otras informaciones contenidas en este documento están sujetas a modificaciones sin previo aviso. Todas las marcas comerciales que aparecen aquí son propiedad de sus respectivos dueños. MIDAS, KLARK TEKNIK, LAB GRUPPEN, LAKE, TANNOY, TURBOSOUND, TC ELECTRONIC, TC HELICON, BEHRINGER, BUGERA y DDA son marcas comerciales o marcas registradas de MUSIC Group IP Ltd. © MUSIC Group IP Ltd. 2017 Reservados todos los derechos.

GARANTÍA LIMITADA

Si quiere conocer los detalles y condiciones aplicables de la garantía así como información adicional sobre la Garantía limitada de MUSIC Group, consulte online toda la información en la web music-group.com/warranty.

EN

ES

FR Consignes de sécurité

 Les points repérés par ce symbole portent une tension électrique suffisante pour constituer un risque d'électrocution.

Utilisez uniquement des câbles d'enceintes professionnels de haute qualité avec fiches Jack mono 6,35 mm ou fiches à verrouillages déjà installées. Toute autre installation ou modification doit être effectuée uniquement par un personnel qualifié.

 Ce symbole avertit de la présence d'une tension dangereuse et non isolée à l'intérieur de l'appareil - elle peut provoquer des chocs électriques.

 **Attention**
Ce symbole signale les consignes d'utilisation et d'entre ! Tien importantes dans la documentation fournie. Lisez les consignes de sécurité du manuel d'utilisation de l'appareil.

 **Attention**
Pour éviter tout risque de choc électrique, ne pas ouvrir le capot de l'appareil ni démonter le panneau arrière. L'intérieur de l'appareil ne possède aucun élément réparable par l'utilisateur. Laisser toute réparation à un professionnel qualifié.

 **Attention**
Pour réduire les risques de feu et de choc électrique, n'exposez pas cet appareil à la pluie, à la moisissure, aux gouttes ou aux éclaboussures. Ne posez pas de récipient contenant un liquide sur l'appareil (un vase par exemple).

 **Attention**
Ces consignes de sécurité et d'entretien sont destinées à un personnel qualifié. Pour éviter tout risque de choc électrique, n'effectuez aucune réparation sur l'appareil qui ne soit décrite par le manuel d'utilisation. Les éventuelles réparations doivent être effectuées uniquement par un technicien spécialisé.

1. Lisez ces consignes.
2. Conservez ces consignes.
3. Respectez tous les avertissements.
4. Respectez toutes les consignes d'utilisation.
5. N'utilisez jamais l'appareil à proximité d'un liquide.
6. Nettoyez l'appareil avec un chiffon sec.
7. Veillez à ne pas empêcher la bonne ventilation de l'appareil via ses ouïes de ventilation. Respectez les consignes du fabricant concernant l'installation de l'appareil.
8. Ne placez pas l'appareil à proximité d'une source de chaleur telle qu'un chauffage, une cuisinière ou tout appareil dégageant de la chaleur (y compris un ampli de puissance).

9. Ne supprimez jamais la sécurité des prises bipolaires ou des prises terre. Les prises bipolaires possèdent deux contacts de largeur différente. Le plus large est le contact de sécurité. Les prises terre possèdent deux contacts plus une mise à la terre servant de sécurité. Si la prise du bloc d'alimentation ou du cordon d'alimentation fourni ne correspond pas à celles de votre installation électrique, faites appel à un électricien pour effectuer le changement de prise.

10. Installez le cordon d'alimentation de telle façon que personne ne puisse marcher dessus et qu'il soit protégé d'arêtes coupantes. Assurez-vous que le cordon d'alimentation est suffisamment protégé, notamment au niveau de sa prise électrique et de l'endroit où il est relié à l'appareil; cela est également valable pour une éventuelle rallonge électrique.

11. Utilisez exclusivement des accessoires et des appareils supplémentaires recommandés par le fabricant.



12. Utilisez exclusivement des chariots, des diables, des présentoirs, des pieds et des surfaces de travail recommandés par le fabricant ou livrés avec le produit.

Déplacez précautionneusement tout chariot ou diable chargé pour éviter d'éventuelles blessures en cas de chute.

13. Débranchez l'appareil de la tension secteur en cas d'orage ou si l'appareil reste inutilisé pendant une longue période de temps.

14. Les travaux d'entretien de l'appareil doivent être effectués uniquement par du personnel qualifié. Aucun entretien n'est nécessaire sauf si l'appareil est endommagé de quelque façon que ce soit (dommages sur le cordon d'alimentation ou la prise par exemple), si un liquide ou un objet a pénétré à l'intérieur du châssis, si l'appareil a été exposé à la pluie ou à l'humidité, s'il ne fonctionne pas correctement ou à la suite d'une chute.

15. L'appareil doit être connecté à une prise secteur dotée d'une protection par mise à la terre.

16. La prise électrique ou la prise IEC de tout appareil dénué de bouton marche/arrêt doit rester accessible en permanence.

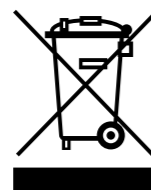

17. Mise au rebut appropriée de ce produit: Ce symbole indique qu'en accord avec la directive DEEE (2012/19/EU) et les lois en vigueur dans votre pays, ce produit ne doit pas être jeté avec les déchets ménagers. Ce produit doit être

déposé dans un point de collecte agréé pour le recyclage des déchets d'équipements électriques et électroniques (EEE). Une mauvaise manipulation de ce type de déchets pourrait avoir un impact négatif sur l'environnement et la santé à cause des substances potentiellement dangereuses généralement associées à ces équipements. En même temps, votre coopération dans la mise au rebut de ce produit contribuera à l'utilisation efficace des ressources naturelles. Pour plus d'informations sur l'endroit où vous pouvez déposer vos déchets

d'équipements pour le recyclage, veuillez contacter votre mairie ou votre centre local de collecte des déchets.

18. N'installez pas l'appareil dans un espace confiné tel qu'une bibliothèque ou meuble similaire.

19. Ne placez jamais d'objets enflammés, tels que des bougies allumées, sur l'appareil.

20. Gardez à l'esprit l'impact environnemental lorsque vous mettez des piles au rebus. Les piles usées doivent être déposées dans un point de collecte adapté.

21. Utilisez l'appareil dans un climat tropical et/ou modéré.

DÉNI LÉGAL

MUSIC Group ne peut être tenu pour responsable pour toute perte pouvant être subie par toute personne se fiant en partie ou en totalité à toute description, photographie ou affirmation contenue dans ce document. Les caractéristiques, l'apparence et d'autres informations peuvent faire l'objet de modifications sans notification. Toutes les marques appartiennent à leurs propriétaires respectifs. MIDAS, KLARK TEKNIK, LAB GRUPPEN, LAKE, TANNOY, TURBOSOUND, TC ELECTRONIC, TC HELICON, BEHRINGER, BUGERA et DDA sont des marques ou marques déposées de MUSIC Group IP Ltd. © MUSIC Group IP Ltd. 2017 Tous droits réservés.

GARANTIE LIMITÉE

Pour connaître les termes et conditions de garantie applicables, ainsi que les informations supplémentaires et détaillées sur la Garantie Limitée de MUSIC Group, consultez le site Internet music-group.com/warranty.

DE Wichtige Sicherheitshinweise

 **Vorsicht**
Die mit dem Symbol markierten Anschlüsse führen so viel Spannung, dass die Gefahr eines Stromschlags besteht.

Verwenden Sie nur hochwertige, professionelle Lautsprecherkabel mit vorinstallierten 6,35 mm MONO-Klinkensteckern oder Lautsprecherstecker mit Drehverriegelung. Alle anderen Installationen oder Modifikationen sollten nur von qualifiziertem Fachpersonal ausgeführt werden.

 **Achtung**
Um eine Gefährdung durch Stromschlag auszuschließen, darf die Geräteabdeckung bzw. Geräterückwand nicht abgenommen werden. Im Innern des Geräts befinden sich keine vom Benutzer reparierbaren Teile. Reparaturarbeiten dürfen nur von qualifiziertem Personal ausgeführt werden.

 **Achtung**
Um eine Gefährdung durch Feuer bzw. Stromschlag auszuschließen, darf dieses Gerät weder Regen oder Feuchtigkeit ausgesetzt werden noch sollten Spritzwasser oder tropfende Flüssigkeiten in das Gerät gelangen können. Stellen Sie keine mit Flüssigkeit gefüllten Gegenstände, wie z. B. Vasen, auf das Gerät.

 **Achtung**
Die Service-Hinweise sind nur durch qualifiziertes Personal zu befolgen. Um eine Gefährdung durch Stromschlag zu vermeiden, führen Sie bitte keinerlei Reparaturen an dem Gerät durch, die nicht in der Bedienungsanleitung beschrieben sind. Reparaturen sind nur von qualifiziertem Fachpersonal durchzuführen.

1. Lesen Sie diese Hinweise.
2. Bewahren Sie diese Hinweise auf.
3. Beachten Sie alle Warnhinweise.
4. Befolgen Sie alle Bedienungshinweise.
5. Betreiben Sie das Gerät nicht in der Nähe von Wasser.
6. Reinigen Sie das Gerät mit einem trockenen Tuch.
7. Blockieren Sie nicht die Belüftungsschlitze. Beachten Sie beim Einbau des Gerätes die Herstellerhinweise.
8. Stellen Sie das Gerät nicht in der Nähe von Wärmequellen auf. Solche Wärmequellen sind z. B. Heizkörper, Herde oder andere Wärme erzeugende Geräte (auch Verstärker).
9. Entfernen Sie in keinem Fall die Sicherheitsvorrichtung von Zweipol- oder geerdeten Steckern. Ein Zweipolstecker hat zwei unterschiedlich breite Steckkontakte. Ein geerdeter Stecker hat zwei Steckkontakte und einen dritten Erdungskontakt. Der breitere Steckkontakt oder der zusätzliche

Erdungskontakt dient Ihrer Sicherheit. Falls das mitgelieferte Steckerformat nicht zu Ihrer Steckdose passt, wenden Sie sich bitte an einen Elektriker, damit die Steckdose entsprechend ausgetauscht wird.

10. Verlegen Sie das Netzkabel so, dass es vor Tritten und scharfen Kanten geschützt ist und nicht beschädigt werden kann. Achten Sie bitte insbesondere im Bereich der Stecker, Verlängerungskabel und an der Stelle, an der das Netzkabel das Gerät verlässt, auf ausreichenden Schutz.

11. Das Gerät muss jederzeit mit intaktem Schutzleiter an das Stromnetz angeschlossen sein.

12. Sollte der Hauptnetzstecker oder eine Gerätesteckdose die Funktionseinheit zum Abschalten sein, muss diese immer zugänglich sein.

13. Verwenden Sie nur Zusatzgeräte/Zubehörteile, die laut Hersteller geeignet sind.



14. Verwenden Sie nur Wagen, Standvorrichtungen, Stative, Halter oder Tische, die vom Hersteller benannt oder im Lieferumfang des Geräts enthalten sind. Falls Sie einen

Wagen benutzen, seien Sie vorsichtig beim Bewegen der Wagen-Gerätkombination, um Verletzungen durch Stolpern zu vermeiden.

15. Ziehen Sie den Netzstecker bei Gewitter oder wenn Sie das Gerät längere Zeit nicht benutzen.

16. Lassen Sie alle Wartungsarbeiten nur von qualifiziertem Service-Personal ausführen. Eine Wartung ist notwendig, wenn das Gerät in irgendeiner Weise beschädigt wurde (z. B. Beschädigung des Netzkabels oder Steckers), Gegenstände oder Flüssigkeit in das Geräteinnere gelangt sind, das Gerät Regen oder Feuchtigkeit ausgesetzt wurde, das Gerät nicht ordnungsgemäß funktioniert oder auf den Boden gefallen ist.



17. Korrekte Entsorgung dieses Produkts: Dieses Symbol weist darauf hin, das Produkt entsprechend der WEEE Richtlinie (2012/19/EU) und der jeweiligen nationalen Gesetze nicht zusammen mit Ihren

Haushaltsabfällen zu entsorgen. Dieses Produkt sollte bei einer autorisierten Sammelstelle für Recycling elektrischer und elektronischer Geräte (EEE) abgegeben werden. Wegen bedenkllicher Substanzen, die generell mit elektrischen und elektronischen Geräten in Verbindung stehen, könnte eine unsachgemäße Behandlung dieser Abfallart eine negative Auswirkung auf Umwelt und Gesundheit haben. Gleichzeitig gewährleistet Ihr Beitrag zur richtigen Entsorgung dieses Produkts die effektive Nutzung natürlicher Ressourcen. Für weitere Informationen zur Entsorgung Ihrer Geräte bei einer Recycling-Stelle nehmen Sie bitte Kontakt zum zuständigen städtischen Büro, Entsorgungsamt oder zu Ihrem Haushaltsabfallentsorger auf.

18. Installieren Sie das Gerät nicht in einer beengten Umgebung, zum Beispiel Bücherregal oder ähnliches.

19. Stellen Sie keine Gegenstände mit offenen Flammen, etwa brennende Kerzen, auf das Gerät.

20. Beachten Sie bei der Entsorgung von Batterien den Umweltschutz-Aspekt. Batterien müssen bei einer Batterie-Sammelstelle entsorgt werden.

21. Verwenden Sie das Gerät in tropischen und/oder gemäßigten Klimazonen.

HAFTUNGS-AUSSCHLUSS

MUSIC Group übernimmt keine Haftung für Verluste, die Personen entstanden sind, die sich ganz oder teilweise auf hier enthaltene Beschreibungen, Fotos oder Aussagen verlassen haben. Technische Daten, Erscheinungsbild und andere Informationen können ohne vorherige Ankündigung geändert werden. Alle Warenzeichen sind Eigentum der jeweiligen Inhaber. MIDAS, KLARK TEKNIK, LAB GRUPPEN, LAKE, TANNOY, TURBOSOUND, TC ELECTRONIC, TC HELICON, BEHRINGER, BUGERA und DDA sind Warenzeichen oder eingetragene Warenzeichen der MUSIC Group IP Ltd. © MUSIC Group IP Ltd. 2017 Alle Rechte vorbehalten.

BESCHRÄNKTE GARANTIE

Die geltenden Garantiebedingungen und zusätzliche Informationen bezüglich der von MUSIC Group gewährten beschränkten Garantie finden Sie online unter music-group.com/warranty.

PT Instruções de Segurança Importantes



Aviso!

Terminais marcados com o símbolo carregam corrente elétrica de magnitude suficiente para constituir um risco de choque elétrico. Use apenas cabos de alto-falantes de alta qualidade com plugues TS de ¼" ou plugues com trava de torção pré-instalados. Todas as outras instalações e modificações devem ser efetuadas por pessoas qualificadas.



Este símbolo, onde quer que o encontre, alerta-o para a leitura das instruções de manuseamento que acompanham o equipamento. Por favor leia o manual de instruções.



Atenção

De forma a diminuir o risco de choque elétrico, não remover a cobertura (ou a secção de trás). Não existem peças substituíveis por parte do utilizador no seu interior. Para esse efeito recorrer a um técnico qualificado.



Atenção

Para reduzir o risco de incêndios ou choques elétricos o aparelho não deve ser exposto à chuva nem à humidade. Além disso, não deve ser sujeito a salpicos, nem devem ser colocados em cima do aparelho objectos contendo líquidos, tais como jarras.



Atenção

Estas instruções de operação devem ser utilizadas, em exclusivo, por técnicos de assistência qualificados. Para evitar choques elétricos não proceda a reparações ou intervenções, que não as indicadas nas instruções de operação, salvo se possuir as qualificações necessárias. Para evitar choques elétricos não proceda a reparações ou intervenções, que não as indicadas nas instruções de operação. Só o deverá fazer se possuir as qualificações necessárias.

1. Leia estas instruções.
2. Guarde estas instruções.
3. Preste atenção a todos os avisos.
4. Siga todas as instruções.
5. Não utilize este dispositivo perto de água.
6. Limpe apenas com um pano seco.
7. Não obstrua as entradas de ventilação. Instale de acordo com as instruções do fabricante.
8. Não instale perto de quaisquer fontes de calor tais como radiadores, bocas de ar quente, fogões de sala ou outros aparelhos (incluindo amplificadores) que produzam calor.
9. Não anule o objectivo de segurança das fichas polarizadas ou do tipo de ligação à terra. Uma ficha polarizada dispõe de duas palhetas sendo uma mais larga do que a outra. Uma ficha do tipo ligação à terra dispõe

de duas palhetas e um terceiro dente de ligação à terra. A palheta larga ou o terceiro dente são fornecidos para sua segurança. Se a ficha fornecida não encaixar na sua tomada, consulte um electricista para a substituição da tomada obsoleta.

10. Proteja o cabo de alimentação de pisadelas ou apertos, especialmente nas fichas, extensões, e no local de saída da unidade. Certifique-se de que o cabo eléctrico está protegido. Verifique particularmente nas fichas, nos receptáculos e no ponto em que o cabo sai do aparelho.
11. O aparelho tem de estar sempre conectado à rede eléctrica com o condutor de protecção intacto.
12. Se utilizar uma ficha de rede principal ou uma tomada de aparelhos para desligar a unidade de funcionamento, esta deve estar sempre acessível.
13. Utilize apenas ligações/acessórios especificados pelo fabricante.



14. Utilize apenas com o carrinho, estrutura, tripé, suporte, ou mesa especificados pelo fabricante ou vendidos com o dispositivo. Quando utilizar um carrinho, tenha cuidado ao

mover o conjunto carrinho/dispositivo para evitar danos provocados pela terpidação.

15. Desligue este dispositivo durante as trovoadas ou quando não for utilizado durante longos períodos de tempo.

16. Qualquer tipo de reparação deve ser sempre efectuado por pessoal qualificado. É necessária uma reparação sempre que a unidade tiver sido de alguma forma danificada, como por exemplo: no caso do cabo de alimentação ou ficha se encontrarem danificados; na eventualidade de líquido ter sido derramado ou objectos terem caído para dentro do dispositivo; no caso da unidade ter estado exposta à chuva ou à humidade; se esta não funcionar normalmente, ou se tiver caído.



17. Correcta eliminação deste produto: este símbolo indica que o produto não deve ser eliminado juntamente com os resíduos domésticos, segundo a Directiva REEE (2012/19/EU) e a legislação nacional. Este produto deverá

ser levado para um centro de recolha licenciado para a reciclagem de resíduos de equipamentos eléctricos e electrónicos (EEE). O tratamento incorrecto deste tipo de resíduos pode ter um eventual impacto negativo no ambiente e na saúde humana devido a substâncias potencialmente perigosas que estão geralmente associadas aos EEE. Ao mesmo tempo, a sua colaboração para a eliminação correcta deste produto irá contribuir para a utilização eficiente dos recursos naturais. Para mais informação acerca dos locais onde poderá deixar o seu equipamento usado para reciclagem, é favor contactar os serviços municipais locais, a entidade de gestão de resíduos ou os serviços de recolha de resíduos domésticos.

18. Não instale em lugares confinados, tais como estantes ou unidades similares.

19. Não coloque fontes de chama, tais como velas acesas, sobre o aparelho.

20. Favor, obedecer os aspectos ambientais de descarte de bateria. Baterias devem ser descartadas em um ponto de coletas de baterias.

21. Use este aparelho em climas tropicais e/ou moderados.

LEGAL RENUNCIANTE

O MUSIC Group não se responsabiliza por perda alguma que possa ser sofrida por qualquer pessoa que dependa, seja de maneira completa ou parcial, de qualquer descrição, fotografia, ou declaração aqui contidas. Dados técnicos, aparências e outras informações estão sujeitas a modificações sem aviso prévio. Todas as marcas são propriedade de seus respectivos donos. MIDAS, KLARK TEKNIK, LAB GRUPPEN, LAKE, TANNOY, TURBOSOUND, TC ELECTRONIC, TC HELICON, BEHRINGER, BUGERA e DDA são marcas ou marcas registradas do MUSIC Group IP Ltd. © MUSIC Group IP Ltd. 2017 Todos direitos reservados.

GARANTIA LIMITADA

Para obter os termos de garantia aplicáveis e condições e informações adicionais a respeito da garantia limitada do MUSIC Group, favor verificar detalhes na íntegra através do website music-group.com/warranty.

JP 安全にお使いいただくために



注意

感電の恐れがありますので、カバーやその他の部品を取り外したり、開けたりしないでください。高品質なプロ用スピーカーケーブル (¼" TS 標準ケーブルおよびツイスト ロッキング プラグケーブル) を使用してください。



注意

火事および感電の危険を防ぐため、本装置を水分や湿気のあるところには設置しないで下さい。装置には決して水分がかからないように注意し、花瓶など水分を含んだものは、装置の上には置かないようにしてください。



注意

このマークが表示されている箇所には、内部に高圧電流が生じています。手を触れると感電の恐れがあります。



注意

取り扱いとお手入れの方法についての重要な説明が付属の取扱説明書に記載されています。ご使用前に良くお読みください。



注意

1. 取扱説明書を通してご覧ください。
2. 取扱説明書を大切に保管してください。
3. 警告に従ってください。
4. 指示に従ってください。
5. 本機を水の近くで使用しないでください。
6. お手入れの際は常に乾燥した布巾を使ってください。
7. 本機は、取扱説明書の指示に従い、適切な換気を妨げない場所に設置してください。取扱説明書に従って設置してください。
8. 本機は、電気ヒーターや温風機器、ストーブ、調理台やアンプといった熱源から離して設置してください。

9. 二極式プラグおよびアースタイプ (三芯) プラグの安全ピンは取り外さないでください。二極式プラグにはピンが二本ついており、そのうち一本はもう一方よりも幅が広がっています。アースタイプの三芯プラグには二本のピンに加えてアース用のピンが一本ついています。これらの幅の広いピン、およびアースピンは、安全のためのものです。備え付けのプラグが、お使いのコンセントの形状と異なる場合は、電器技師に相談してコンセントの交換をして下さい。

10. 電源コードを踏みつけたり、挟んだりしないようご注意ください。電源コードやプラグ、コンセント及び製品との接続には十分にご注意ください。

11. すべての装置の接地 (アース) が確保されていることを確認して下さい。



12. 電源タップや電源プラグは電源遮断機として利用されている場合には、これが直ぐに操作できるように手元に設置して下さい。

13. 付属品は本機製造元が指定したもののみをお使いください。

14. カートスタンド、三脚、ブラケット、テーブルなどは、本機製造元が指定したものの、もしくは本機の付属品となるもののみをお使いください。カートを使用時の運搬の際は、器具の落下による怪我に十分ご注意ください。

15. 雷雨の場合、もしくは長期間ご使用にならない場合は、電源プラグをコンセントから抜いてください。

16. 故障の際は当社指定のサービス技術者にお問い合わせください。電源コードもしくはプラグの損傷、液体の装置内への浸入、装置の上に物が落下した場合、雨や湿気に装置が晒されてしまった場合、正常に作動しない場合、もしくは装置を地面に落下させてしまった場合など、いかなる形であれ装置に損傷が加わった場合は、装置の修理・点検を受けてください。

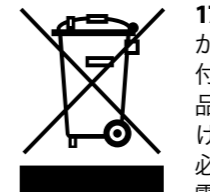

17. 本製品に電源コードが付属されている場合、付属の電源コードは本製品以外ではご使用いたしません。電源コードは必ず本製品に付属された電源コードのみご使用ください。

18. ブックケースなどのような、閉じたスペースには設置しないでください。

19. 本機の上に点火した蝋燭などの裸火を置かないでください。

20. 電池廃棄の際には、環境へのご配慮をお願いします。電池は、かならず電池回収場所に廃棄してください。

21. 本機器は熱帯気候および / または温帯気候下でご使用ください。

法的放棄

ここに含まれる記述、写真、意見の全体または一部に依拠して、いかなる人が損害を生じさせた場合にも、MUSIC Groupは一切の賠償責任を負いません。技術仕様、外観およびその他の情報は予告なく変更になる場合があります。商標はすべて、それぞれの所有者に帰属します。MIDAS, KLARK TEKNIK, LAB GRUPPEN, LAKE, TANNOY, TURBOSOUND, TC ELECTRONIC, TC HELICON, BEHRINGER, BUGERA および DDA は MUSIC Group IP Ltd. の商標または登録商標です。© MUSIC Group IP Ltd. 2017 無断転用禁止。

限定保証

適用される保証条件と MUSIC Group の限定保証に関する概要については、オンライン上 music-group.com/warranty にて詳細をご確認ください。

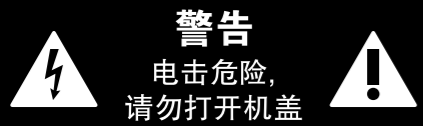
CN 其他的重要信息

 带有此标志的终端设备具有强大的电流, 存在触电危险。仅限使用带有 ¼" TS 或扭锁式插头的高品质专业扬声器线。所有的安装或调整均须由合格的专业人员进行。

 此标志提醒您, 产品内存在未绝缘的危险电压, 有触电危险。

 此标志提醒您查阅所附的重要的使用及维修说明。请阅读有关手册。

 **小心**
为避免触电危险, 请勿打开机顶盖 (或背面挡板)。设备内没有可供用户维修使用的部件。请将维修事项交由合格的专业人员进行。

 **小心**
为避免着火或触电危险, 请勿将此设备置于雨淋或潮湿中。此设备也不可受液体滴溅, 盛有液体的容器也不可置于其上, 如花瓶等。

 **小心**
维修说明仅是给合格的专业维修人员使用的。为避免触电危险, 除了使用说明书提到的以外, 请勿进行任何其它维修。所有维修均须由合格的专业人员进行。

1. 请阅读这些说明。
2. 请妥善保管这些说明。
3. 请注意所有的警示。
4. 请遵守所有的说明。
5. 请勿在靠近水的地方使用本产品。
6. 请用干布清洁本产品。
7. 请勿堵塞通风口。安装本产品时请遵照厂家的说明。
8. 请勿将本产品安装在热源附近, 如暖气片, 炉子或其它产生热量的设备 (包括功放器)。
9. 请勿移除极性插头或接地插头的安全装置。接地插头是由两个插塞接点及一个接地头构成。若随货提供的插头不适合您的插座, 请找电工更换一个合适的插座。
10. 妥善保护电源线, 使其不被践踏或刺破, 尤其注意电源插头、多用途插座及设备连接处。

11. 请只使用厂家指定的附属设备和配件。



12. 请只使用厂家指定的或随货销售的手推车, 架子, 三角架, 支架和桌子。若使用手推车来搬运设备, 请注意安全放置设备, 以避免手推车和设备

倾倒而受伤。

13. 遇闪电雷鸣或长期不使用本设备时, 请拔出电源插头。

14. 所有维修均须由合格的维修人员进行。设备受损时需进行维修, 例如电源线或电源插头受损, 液体流入或异物落入设备内, 设备遭雨淋或受潮, 设备不能正常运作或被摔坏。

15. 本设备连接电源时一定要接地保护。



16. 若电源插头或器具耦合器用作断电装置, 应当保证它们处于随时可方便操作状态。

17. 本产品仅适用于海拔 2000 米以下地区, 本产品仅适用于非热带气候条件下。

**法律声明**

对于任何因在此说明书提到的全部或部份描述、图片或声明而造成的损失, MUSIC Group 不负任何责任。技术参数和外观若有更改, 恕不另行通知。所有的商标均为其各自所有者的财产。MIDAS, KLARK TEKNIK, LAB GRUPPEN, LAKE, TANNOY, TURBOSOUND, TC ELECTRONIC, TC HELICON, BEHRINGER, BUGERA 和 DDA 是 MUSIC Group IP Ltd. 公司的商标或注册商标。© MUSIC Group IP Ltd. 2017 版权所有。

保修条款

有关音乐集团保修的适用条款及其它相关信息, 请登陆 music-group.com/warranty 网站查看完整的详细信息。

Welcome

Thank you for choosing a TURBOSOUND loudspeaker product for your application. If you would like further information about this or any other product, please visit our website at turbosound.com.

Unpacking the Loudspeaker

After unpacking the unit, please check carefully for damage. If damage is found, please notify your supplier at once. You, the consignee, must instigate any claim. Please retain all packaging in case of future return shipment.

System Requirements

TLX43 and TLX84 are bi-amp 2-way loudspeakers. Operation (full range or with a subwoofer) requires 2 amplifier channels and 2 controller channels, one for low frequencies and one for high frequencies. The input signal is divided between the low frequency and high frequency driver in the controller and the individual amplified signals are fed to the speaker input. Typically 4 loudspeakers can be run from 2 amplifier channels by wiring speakers in parallel.

TLX212L and TLX215L subwoofers require 1 amplifier channel and 1 controller channel. The required filters and conditioning is applied to the signal in the controller and the individual amplified signals are fed to the speaker input.

Correct controller settings for operation of all models and subwoofers can be downloaded from turbosound.com, and are also available as presets for the LAKE LM series controllers and LAB GRUPPEN DSP amplifiers.

To avoid wasting amplifier power, you should use heavy-duty speaker cable with a minimum wire size of 2.5 mm² (14 AWG), and preferably 4 mm² (12 AWG) for longer runs or where total cabinet input impedance is less than 8 ohms. For extreme cable lengths, be aware of cable impedance and resistive losses. Always observe the correct polarity.

EN

Amplifier Considerations

LIVERPOOL series loudspeakers are optimized for use with LAKE LM series controllers and LAB GRUPPEN amplifiers or LAB GRUPPEN DSP amplifiers with LAKE processing. A full range of DSP presets to suit a variety of configurations is provided for download on the TURBOSOUND website where limiters, crossover points, corrective component time alignment and equalisation are pre-programmed to ensure optimum sound quality and long-term reliability. Use LAB GRUPPEN 'CAFE' software - available for download from labgruppen.com - to determine the optimum amplifier configuration for your system. Parameters for the use of third party amplification and processing can be provided upon request.

LIVERPOOL series loudspeaker enclosures should be driven by high quality power amplifiers designed for true professional use. The use of under powered amplifiers must be avoided as heavily clipped signals can cause permanent loudspeaker damage. For subwoofers, passive loudspeakers and low frequency, mid frequency sections of multi-way active loudspeakers, amplifiers should be capable of delivering power equal to twice the continuous power rating at the stated nominal impedance. For the high frequency section of multi-way active loudspeakers, amplifiers should be capable of delivering power equal to ten times the continuous power rating at the stated nominal impedance.

Model		TLX43	TLX212L	TLX84	TLX215L		
Mode		Bi-amp LF	Bi-amp HF	SUB	Bi-amp LF	Bi-amp HF	SUB
Impedance (ohms)		16	16	8	16	16	4
Power Handling (W)	Continuous RMS	150	30	800	450	60	1,000
	Peak	600	120	3,200	1,800	240	4,000
Minimum Recommended Amplification (W)		300	300	1,600	900	600	2,000

NOTE: Power 1x TLX215L or 2x TLX212L subwoofers per amplifier channel (4 ohm load)

NOTE: Since TLX subwoofers are wired 1+/- = LF1|LF2; 2+/- = LINK, in order to power multiple TLX212L or TLX215L enclosures, it is advised to construct SUB LINK cables wired: 2+ -> 1+ and 2- -> 1-. A single NL4 cable from LAB GRUPPEN bi-wired NL4 outputs (Channel 1 = 1+/-; Channel 2 = 2+/- or Channel 3 = 1+/-; Channel 4 = 2+/-) connects to the first TLX215L subwoofer then the SUB LINK cable jumps to the second TLX215L subwoofer, providing one TLX215L subwoofer per amplifier channel. For TLX212L, standard NL4 link cables can be used in conjunction with SUB LINK cables to power two TLX212L subwoofers per amplifier channel. Refer to wiring diagrams below for further details.

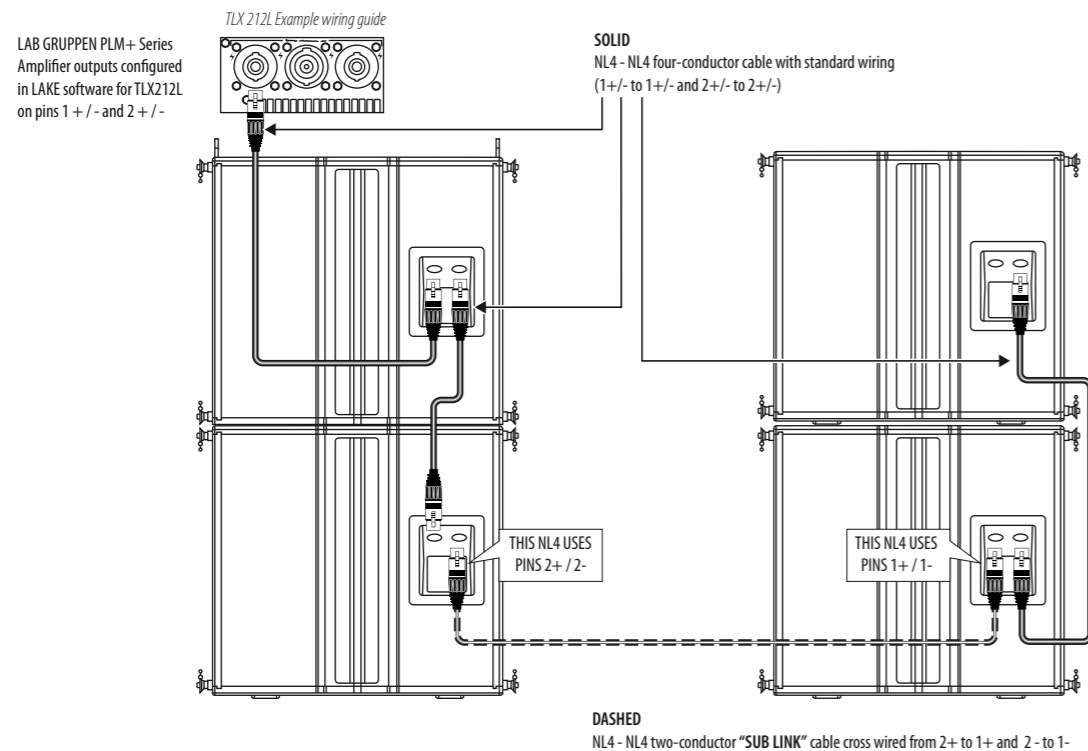

NOTE: To use all 4 channels of a LAB GRUPPEN PLM+ Series Amplifier to drive 8 x TLX212L total, repeat for channel 3,4 outputs and ensure correct output routing in LAKE software.

Connections

EN

Mode	Back Panel	Connector	Internal Schematic
TLX43		BI-AMP, Input Low + Amplifier Channel 1 → 1- BI-AMP, Input Low - → 1+ BI-AMP, Input High + → 2+ Amplifier Channel 2 → 2- BI-AMP, Input High -	NL4 Input/Link 1+ → HF 1- → HF 2+ → LF 1 2- → LF 1 1+ → LF 2 1- → LF 2 2+ → LF 2 2- → LF 2
TLX212L		Input SUB + → 1- Input SUB - → 1+ 2+ 2-	NL4 Input/Link 1+ → LF 1 1- → LF 1 2+ → LF 2 2- → LF 2 NL4 Input/Link 1+ → LF 2 1- → LF 2 2+ → LF 2 2- → LF 2
TLX84		BI-AMP, Input Low + Amplifier Channel 1 → 1- BI-AMP, Input Low - → 1+ BI-AMP, Input High + → 2+ Amplifier Channel 2 → 2- BI-AMP, Input High -	NL4 Input/Link 1+ → HF 1 1- → HF 1 2+ → HF 2 2- → HF 2 NL4 Input/Link 1+ → LF 1 1- → LF 1 2+ → LF 2 2- → LF 2
TLX215L		Input SUB + → 1- Input SUB - → 1+ 2+ 2-	NL4 Input/Link 1+ → LF 1 1- → LF 1 2+ → LF 2 2- → LF 2 NL4 Input/Link 1+ → LF 2 1- → LF 2 2+ → LF 2 2- → LF 2

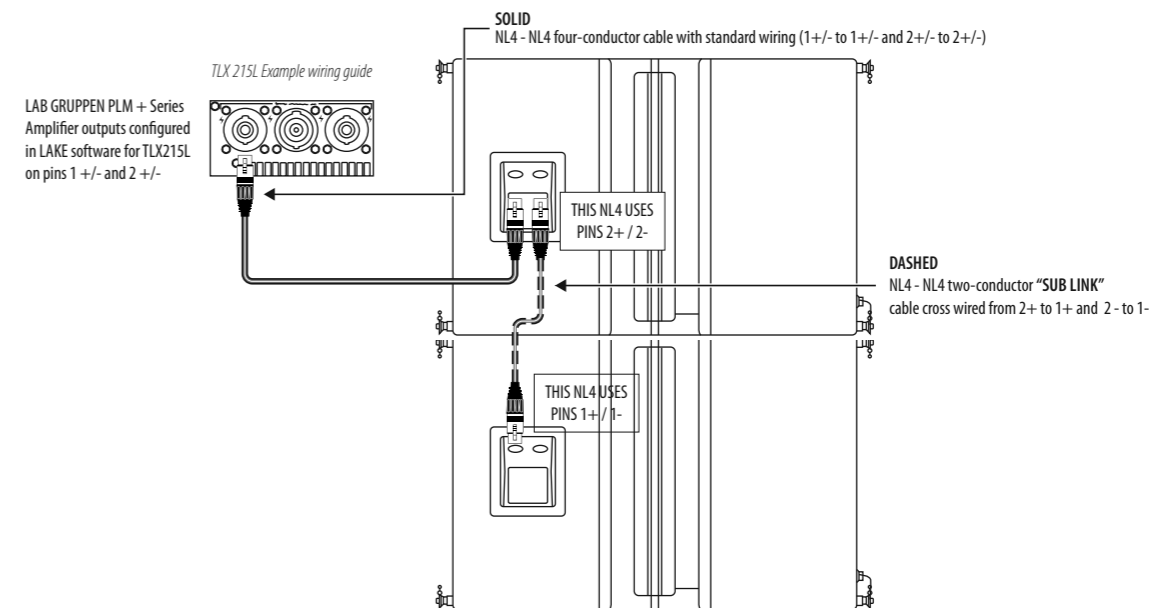

NOTE: To use all 4 channels of a LAB GRUPPEN PLM+ Series Amplifier to drive 4 x TLX215L total, repeat for channel 3,4 outputs and ensure correct output routing in LAKE software.

EN Rigging and Acoustic Simulation Software

Refer to TLX Liverpool Series Rigging Manuals for safe suspension and installation of the loudspeakers, flybars and all suspension hardware.

TLX Series loudspeakers and flybars are designed and tested to strict BGV-C1 standards. Suspension of these speakers must be performed in accordance with the rigging manual supplied with the respective flybars and available online at turbosound.com

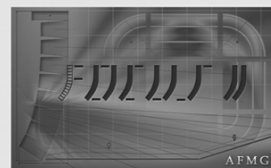

Full EASE data can be downloaded from turbosound.com. This will allow both acoustic prediction, and array formation and suspension to be determined.

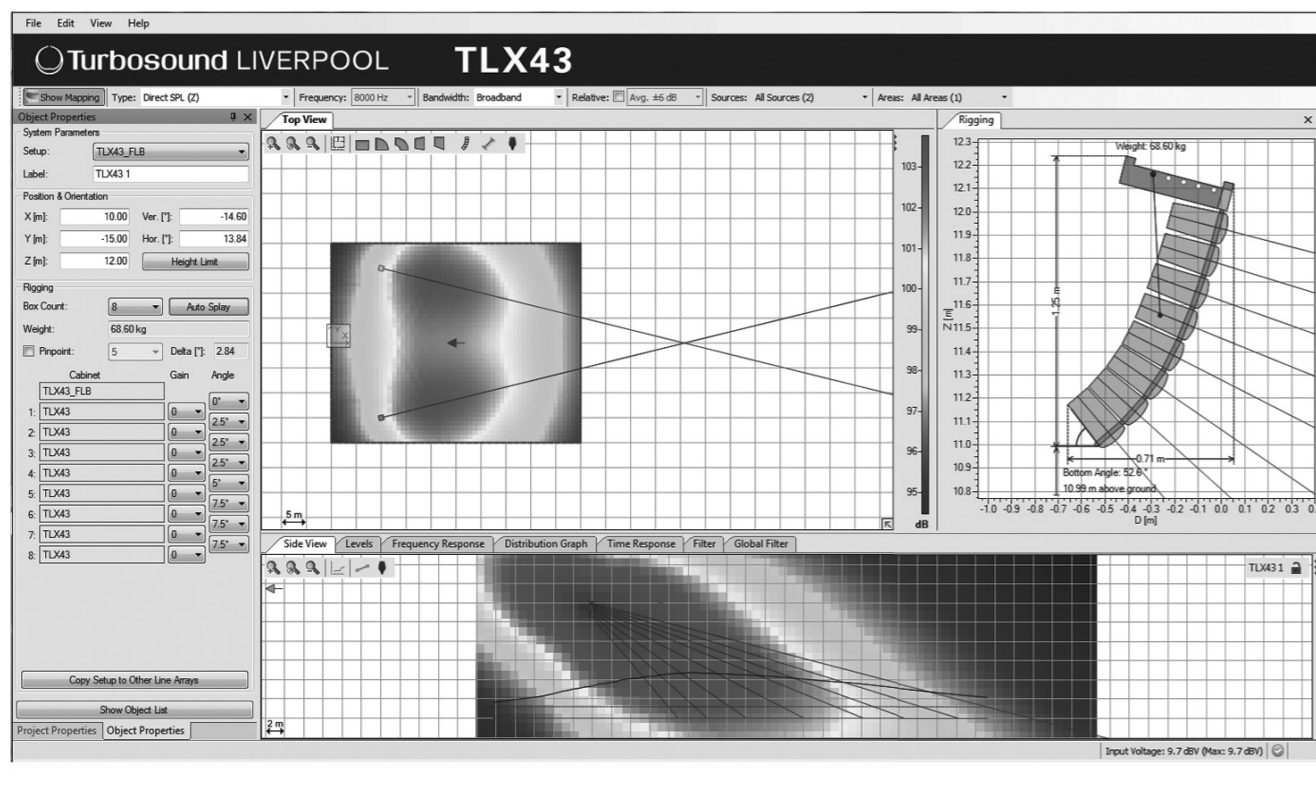

Suspended Arrays

! Safety Warning: Only authorised and certified personnel shall design and install suspended configurations, following the instructions and procedures in the rigging manuals supplied with the TLX43-FLB and TLX84-FLB flybars or downloaded from turbosound.com. Failure to follow these instructions may lead to death or permanent injury.

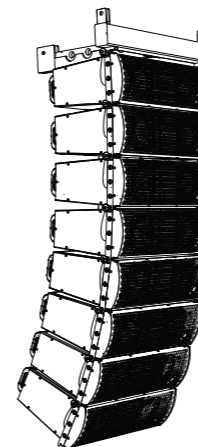

Example showing an array of 8 TLX43 loudspeakers with the TLX43-FLB flybar attached on the top.

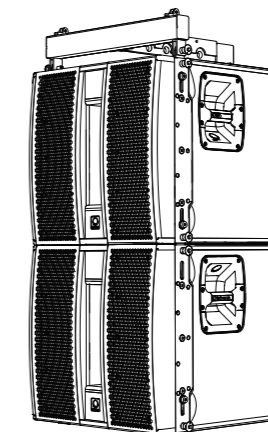

Example showing an array of 2 TLX212L subwoofers with the TLX43-FLB flybar attached on the top.

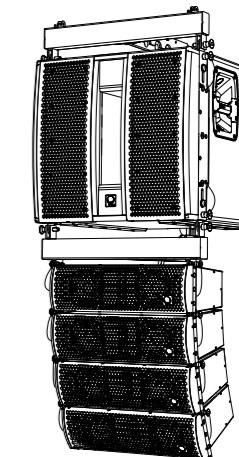

Example showing a mixed array with 1 TLX212L subwoofer, 4 TLX43 loudspeakers and 2 TLX43-FLB flybars.

The TLX215L and TLX84 loudspeakers can be also be suspended in similar configurations, except only the top flybar is required for the mixed array.

! For maximum array sizes, weights and working load limits, please consult the TLX43-FLB or TLX84-FLB rigging manual.

Ground Stacking

! Safety Warning: Only authorised personnel shall design and rig the ground stacked configuration, following the instructions and procedures in the manual supplied with the flybars or downloaded from turbosound.com. Failure to follow these instructions may lead to death or permanent injury

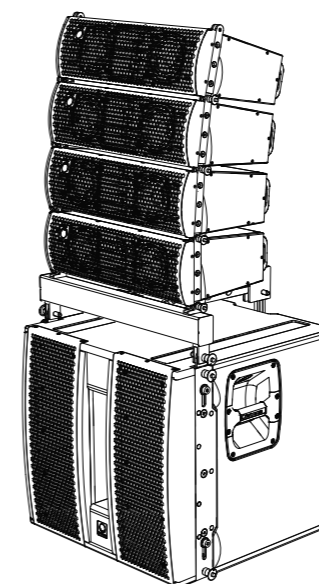



The TLX212L and TLX43 loudspeakers can be configured in a mixed-array ground stack, with the TLX212L subwoofer on the ground or stage, the TLX43-FLB flybar attached on top, and the TLX43 mid/top cabinets attached to the flybar.

The TLX215L and TLX84 loudspeakers can be configured in a ground stack with the TLX215L subwoofer on the ground or stage, and the TLX84 mid/top cabinets mounted directly above it. No flybar is required for this ground stack.

EN

LAKE Preset Overlays and Application Notes

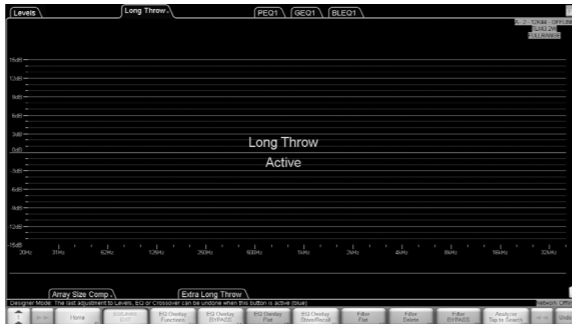
TLX Series preset modules for LAKE LM series controllers and LAB GRUPPEN / LAKE DSP amplifiers (PLM+, D Series L) include preset overlays to assist with system tuning and optimisation. Four preset overlays are available: 1) Array Size Compensation; 2) Band Level EQ (BLEQ); 3) Long Throw (LT); 4) Extra Long Throw (XLT). Note: bypassing both LT and XLT overlays provides Short Throw (ST) mode.

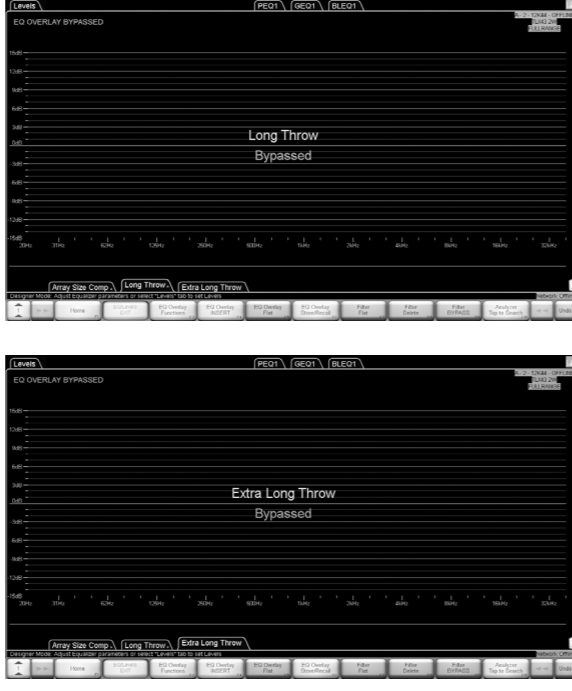
OVERLAY DESCRIPTION	OVERLAY
<p>Long Throw Mode is intended for medium- to long-throw applications and is suitable for small to medium sized arrays consisting of 4-8 TLX43 or TLX84 enclosures. The 6 dB low-frequency shelving characteristic offsets LF/MF array coupling and high-frequency shelving pre-emphasis compensates for air absorption over typical throw distances for nominally focused arrays with equal site angle impact spacing over the desired audience coverage area. Additional equalization above 16 kHz optimizes system gain structure while maximizing overall A-weighted SPL output.</p>	
<p>Extra Long Throw Mode is intended for medium-, long-, or extra-throw applications and is suitable for medium to large sized arrays consisting of more than 8 TLX43 or TLX84 enclosures. The 6 dB low-frequency shelving offsets LF/ MF array coupling and high-frequency shelving pre-emphasis compensates for air absorption over typical throw distances for nominally focused arrays with equal site angle impact spacing over the desired audience coverage area. Additional HF shelving equalization above 16 kHz optimizes high frequency extension.</p>	
<p>Short Throw Mode has nominally-flat low and high frequency response and is suitable for smaller arrays consisting of 1-3 TLX43 or TLX84 enclosures. Short throw applications include: distributed front fill, stacked side fill for stage monitoring or stacked theatre / club systems intended for short throw front-of-house sound reinforcement.</p>	

EN

ARRAY SIZE COMPENSATION

The array size compensation overlay provides a convenient control to compensate for the LF versus MH tonal balance offset that occurs for larger arrays. Lowering the MESA filter compensates for low-mid buildup in the 100-300 Hz region and the Low Shelf filter can be used to achieve the overall desired LF versus MH tonal balance characteristic.

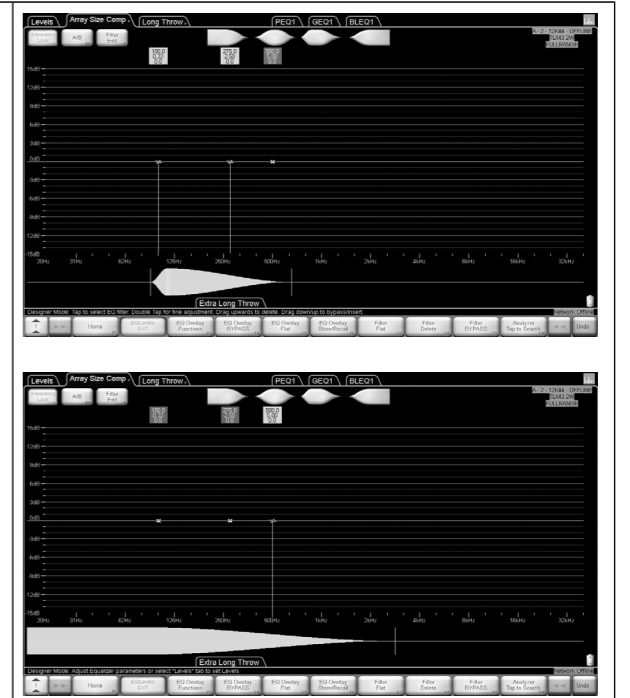

BAND LEVEL EQ (BLEQ)

The Band Level EQ overlay can be used for circuit level gain shading and tapering adjustments. Band level shading adjustment is recommended as opposed to LF, MF, HF output channel gain shading in order to preserve proper summation and power response between adjacent bands.

Note: It is not recommended to mix ST, LT and XLT modes within the same array (for example, ST mode on lower circuits, LT mode on middle circuits and XLT on upper circuits of the array). For more precise control of SPL distribution and frequency response throughout the intended array coverage region, all array circuits should be operated in ST, LT or XLT mode and circuit-level gain shading and tapering adjustments implemented using the Band Level EQ Overlay.

For short-to-medium throw applications, use ST presets for all array circuits and apply HF shelving boost to upper circuits.

For medium-to-long throw applications, use LT or XLT mode for all array circuits and apply HF shelving reduction to lower circuits.

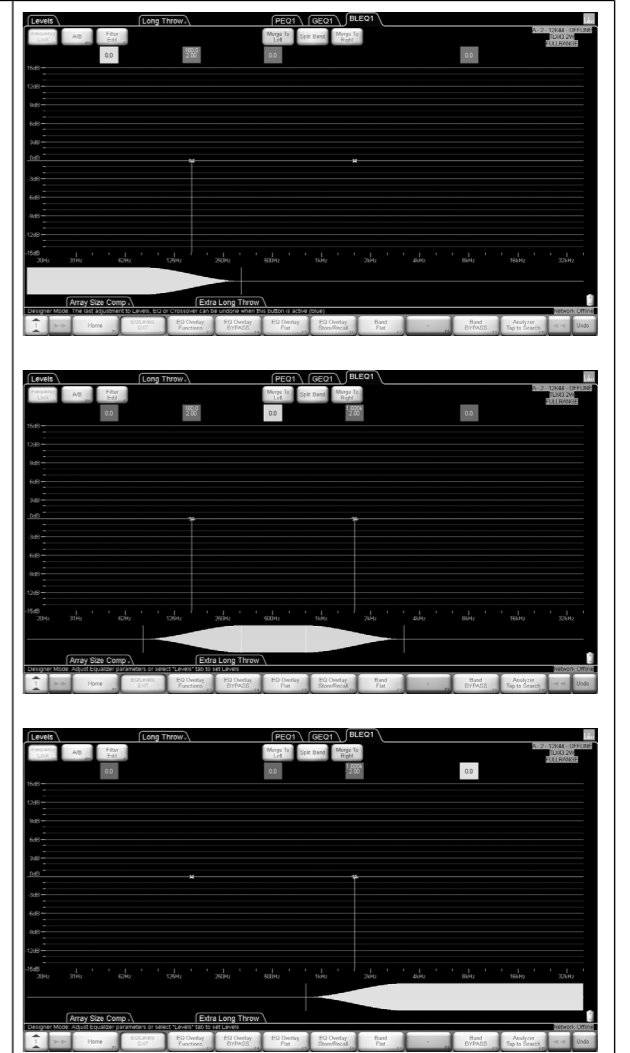

Subwoofer Time Alignment

TURBOSOUND TLX LAKE DSP settings include user adjustable delays on TLX43, TLX84, TLX212L and TLX215L channels.

For example: If the fronts of the TLX43 & TLX212L are aligned then in both pre-sets the delay should be set to the default which is 0ms.

However in the real world it is not always possible to have your flown array and your ground stacked bass aligned in the vertical plane.

1) In the picture to the right the TLX212L bass is 'forward' of the TLX43 flown array. So the TLX212L needs to be delayed.

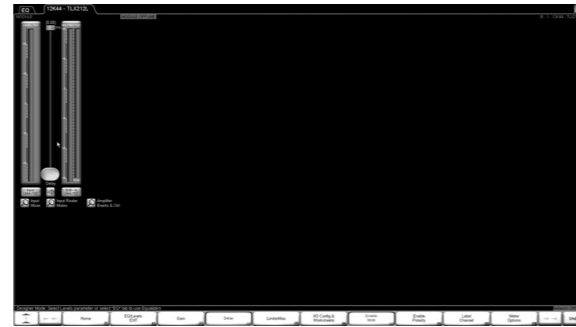
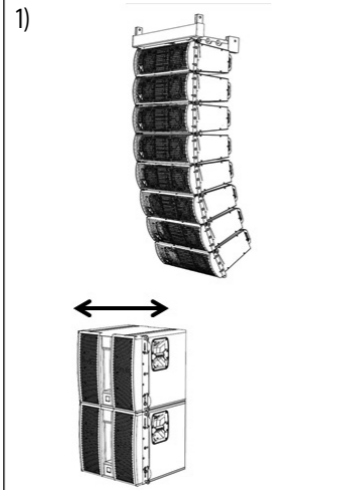

2) In the picture to the right the TLX43 flown array is now 'forward' of the TLX212L ground stacked bass. So the TLX43 array needs to be delayed.

So how do you find the correct delay time to align the flown array to the ground stacked bass?

Some basic knowledge of delay units can get you an acceptable result by measuring the distance between the fronts of the flown array and the front of the ground stacked array. Remember within LAKE software you can choose the delay unit; ms, m or feet.

$$1 \text{ ms (milliseconds)} = 0.343 \text{ m (meters)} = 1.125 \text{ ft (feet)}$$

Further fine tuning can be done by using one of the many industry standard measurement software systems, reference microphones and sound-cards. LAKE software offers integration to many of these software systems, further information can be found at www.labgruppen.com

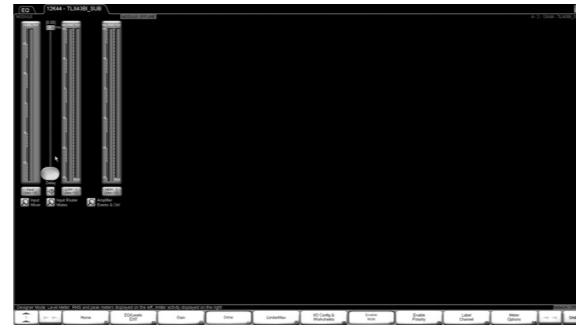
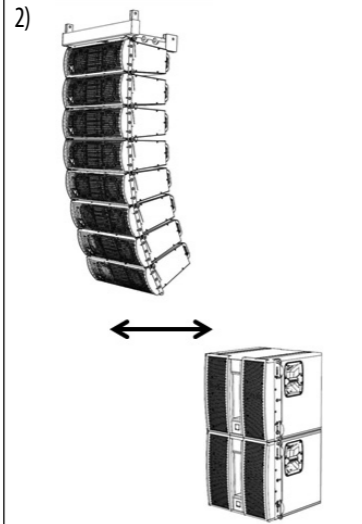

Technical Specifications

	TLX43	TLX84	TLX212L	TLX215L
System				
Frequency response	85 Hz – 20 kHz ±3 dB 70 Hz – 20 kHz -10 dB	67 Hz – 20 kHz ±3 dB 58 Hz – 20 kHz -10 dB	49 Hz - 173 Hz ±3 dB 38 Hz - 213 Hz -10 dB	48 Hz - 150 Hz ±3 dB 40 Hz - 200 Hz -10 dB
Nominal dispersion	120° H x 10° V @ -6 dB points	100° H x 10° V @ -6 dB points	Half space	Half space
Power handling (IEC)	LF: 150 W continuous, 600 W peak HF: 30 W continuous, 120 W peak	LF: 450 W continuous, 1,800 W peak HF: 60 W continuous, 240 W peak	800 W continuous, 3,200 W peak	1000 W continuous, 4,000 W peak
Sensitivity	LF: 87 dB (1 W @ 1 m) HF: 99 dB (1 W @ 1 m)	LF: 94 dB (1 W @ 1 m) HF: 101 dB (1 W @ 1 m)	98 dB (1 W @ 1 m)	101 dB (1 W @ 1 m)
Maximum SPL	LF: 109 dB continuous, 115 dB peak HF: 114 dB continuous, 120 dB peak	LF: 121 dB continuous, 127 dB peak HF: 119 dB continuous, 125 dB peak	127 dB continuous, 133 dB peak	131 dB continuous, 137 dB peak
Impedance	LF: 16 Ω HF: 16 Ω	LF: 16 Ω HF: 16 Ω	8 Ω	4 Ω
Crossover type	External bi-amp	External bi-amp	—	—
Components	2 x 4" (102 mm) LF driver 1 x 1" (25.4 mm) HF compression driver	2 x 8" (203 mm) LF driver 2 x 1" (25.4 mm) HF compression driver	2 x 12" (305 mm) LF driver	2 x 15" (381 mm) LF driver
Enclosure				
Connectors	2 x Neutrik speakON® NL4	2 x Neutrik speakON® NL4	2 x Neutrik speakON® NL4	2 x Neutrik speakON® NL4
Wiring	Pins 1+ / 1- LF, pins 2+ / 2- HF	Pins 1+ / 1- LF, pins 2+ / 2- HF	Pins 1+ / 1- input, pins 2+ / 2- link	Pins 1+ / 1- input, pins 2+ / 2- link
Dimensions H x W x D	163 x 512 x 290 mm (6.4 x 20.2 x 11.4")	245 x 801 x 485 mm (9.6 x 31.5 x 19.1")	488 x 576 x 542 mm (19.2 x 22.7 x 21.3")	506 x 802 x 751 mm (19.9 x 31.6 x 29.6")
Net weight	8.0 kg (17.6 lbs)	27.9 kg (61.4 lbs)	43.0 kg (94.8 lbs)	65.0 kg (143 lbs)
Construction	12 mm (½") plywood	15 mm (⅝") plywood	15 mm (⅝") plywood	18 mm (¾") plywood
Finish	Semi matt black paint	Semi matt black paint	Semi matt black paint	Semi matt black paint
Grille	Powder coated perforated steel	Powder coated perforated steel	Powder coated perforated steel	Powder coated perforated steel
Flying hardware	Integral variable curvature	Integral variable curvature	Integral	Integral
Accessories				
	TLX43-FLB fly bar	TLX84-FLB fly bar	TLX212L-WHB wheel board	TLX215L-WHB wheel board
	TLX43-RC4 road case	TLX84-RC4 road case	TLX43-FLB fly bar	TLX84-FLB fly bar

Other important information

EN Important information

1. Register online. Please register your new MUSIC Group equipment right after you purchase it by visiting turbosound.com. Registering your purchase using our simple online form helps us to process your repair claims more quickly and efficiently. Also, read the terms and conditions of our warranty, if applicable.

2. Malfunction. Should your MUSIC Group Authorized Reseller not be located in your vicinity, you may contact the MUSIC Group Authorized Fulfiller for your country listed under "Support" at turbosound.com. Should your country not be listed, please check if your problem can be dealt with by our "Online Support" which may also be found under "Support" at behringer.com. Alternatively, please submit an online warranty claim at turbosound.com BEFORE returning the product.

3. Power Connections. Before plugging the unit into a power socket, please make sure you are using the correct mains voltage for your particular model. Faulty fuses must be replaced with fuses of the same type and rating without exception.

ES Aspectos importantes

1. Registro online. Le recomendamos que registre su nuevo aparato MUSIC Group justo después de su compra accediendo a la página web turbosound.com. El registro de su compra a través de nuestro sencillo sistema online nos ayudará a resolver cualquier incidencia que se presente a la mayor brevedad posible. Además, aproveche para leer los términos y condiciones de nuestra garantía, si es aplicable en su caso.

2. Averías. En el caso de que no exista un distribuidor MUSIC Group en las inmediaciones, puede ponerse en contacto con el distribuidor MUSIC Group de su país, que encontrará dentro del apartado "Support" de nuestra página web turbosound.com. En caso de que su país no aparezca en ese listado, acceda a la sección "Online Support" (que también encontrará dentro del apartado "Support" de nuestra página web) y compruebe si su problema aparece descrito y solucionado allí. De forma alternativa, envíenos a través de la página web una solicitud online de soporte en periodo de garantía ANTES de devolvernos el aparato.

3. Conexiones de corriente. Antes de enchufar este aparato a una salida de corriente, asegúrese de que dicha salida sea del voltaje adecuado para su modelo concreto. En caso de que deba sustituir un fusible quemado, deberá hacerlo por otro de idénticas especificaciones, sin excepción.

FR Informations importantes

1. Enregistrez-vous en ligne. Prenez le temps d'enregistrer votre produit MUSIC Group aussi vite que possible sur le site Internet turbosound.com. Le fait d'enregistrer le produit en ligne nous permet de gérer les réparations plus rapidement et plus efficacement. Prenez également le temps de lire les termes et conditions de notre garantie.

2. Dysfonctionnement. Si vous n'avez pas de revendeur MUSIC Group près de chez vous, contactez le distributeur MUSIC Group de votre pays : consultez la liste des distributeurs de votre pays dans la page "Support" de notre site Internet turbosound.com. Si votre pays n'est pas dans la liste, essayez de résoudre votre problème avec notre "aide en ligne" que vous trouverez également dans la section "Support" du site turbosound.com. Vous pouvez également nous faire parvenir directement votre demande de réparation sous garantie par Internet sur le site behringer.com AVANT de nous renvoyer le produit.

3. Raccordement au secteur. Avant de relier cet équipement au secteur, assurez-vous que la tension secteur de votre région soit compatible avec l'appareil. Veillez à remplacer les fusibles uniquement par des modèles exactement de même taille et de même valeur électrique — sans aucune exception.

DE Weitere wichtige Informationen

1. Online registrieren. Bitte registrieren Sie Ihr neues MUSIC Group-Gerät direkt nach dem Kauf auf der Website turbosound.com. Wenn Sie Ihren Kauf mit unserem einfachen online Formular registrieren, können wir Ihre Reparaturansprüche schneller und effizienter bearbeiten. Lesen Sie bitte auch unsere Garantiebedingungen, falls zutreffend.

2. Funktionsfehler. Sollte sich kein MUSIC Group Händler in Ihrer Nähe befinden, können Sie den MUSIC Group Vertrieb Ihres Landes kontaktieren, der auf turbosound.com unter „Support“ aufgeführt ist. Sollte Ihr Land nicht aufgelistet sein, prüfen Sie bitte, ob Ihr Problem von unserem „Online Support“ gelöst werden kann, den Sie ebenfalls auf turbosound.com unter „Support“ finden. Alternativ reichen Sie bitte Ihren Garantieanspruch online auf behringer.com ein, BEVOR Sie das Produkt zurücksenden.

3. Stromanschluss. Bevor Sie das Gerät an eine Netzsteckdose anschließen, prüfen Sie bitte, ob Sie die korrekte Netzspannung für Ihr spezielles Modell verwenden. Fehlerhafte Sicherungen müssen ausnahmslos durch Sicherungen des gleichen Typs und Nennwerts ersetzt werden.

PT Outras Informações Importantes

1. Registre-se online. Por favor, registre seu novo equipamento MUSIC Group logo após a compra visitando o site turbosound.com. Registrar sua compra usando nosso simples formulário online nos ajuda a processar seus pedidos de reparos com maior rapidez e eficiência. Além disso, leia nossos termos e condições de garantia, caso seja necessário.

2. Funcionamento Defeituoso. Caso seu fornecedor MUSIC Group não esteja localizado nas proximidades, você pode contatar um distribuidor MUSIC Group para o seu país listado abaixo de "Suporte" em turbosound.com. Se seu país não estiver na lista, favor checar se seu problema pode ser resolvido com o nosso "Suporte Online" que também pode ser achado abaixo de "Suporte" em behringer.com. Alternativamente, favor enviar uma solicitação de garantia online em turbosound.com ANTES da devolução do produto.

3. Ligações. Antes de ligar a unidade à tomada, assegure-se de que está a utilizar a voltagem correcta para o modelo em questão. Os fusíveis com defeito terão de ser substituídos, sem qualquer excepção, por fusíveis do mesmo tipo e corrente nominal.

