

## Install

# DVS 6-WH

6" Coaxial Surface-Mount Loudspeaker for Installation Applications (White)

- Full range surface-mount loudspeaker for indoor and outdoor installation applications
- 60 Watts continuous, 240 Watts peak power
- 6" mineral loaded polypropylene driver with nitrile rubber surround for enhanced durability and long-term reliability
- 0.75" ferrofluid cooled soft dome neodymium high frequency driver
- 90° constant directivity dispersion for optimum coverage
- UL 1480 certified for general signalling systems
- UV and weather resistant UL 94 V-0 ABS enclosure
- 6 Ohm direct input for low impedance applications
- All components weather resistant to IP64 for outdoor use
- Stylish durable enclosure in a semi matt white paint finish fits unobtrusively in any environment
- Painted perforated aluminium mesh grille with dust protection
- Yoke bracket included for ease of installation
- Phoenix\* connectors input and link output
- 10-Year Warranty Program\*
- Designed and engineered in the U.K.

Designed to excel in a wide variety of sound reinforcement applications, the full range DVS 6-WH is an ultra-compact 240-Watt surface mount loudspeaker that provides both exceptional value and inspiring acoustic performance. The DVS 6-WH is ideally suited for stereo or mono background/foreground music applications in theme parks, hotels, restaurants and bars, retail stores, as well as corporate AV, residential developments, and houses of worship.



## Superb Point-Source Performance

DVS 6-WH's point-source design comprises a 150 mm (6.00") mid bass driver with a coaxially mounted 19 mm (0.75") high frequency section mounted in a stylish injection moulded ABS enclosure. Certified for water and dust ingress protection to IP64 standard, the DVS 6-WH is an exceptional choice for challenging environments such as indoor swimming pools, saunas, or work areas with unusually high levels of dust or moisture, and outdoor applications where weather conditions are moderate.

## Install

# DVS 6-WH

6" Coaxial Surface-Mount Loudspeaker for Installation Applications (White)

### Attractive and Easy to Install

The highly durable and scuff resistant ABS enclosure features a white painted finish, and comes with an aesthetically pleasing aluminium grille. Installation is quick and easy, thanks to the included colour-matched steel mounting bracket and finger-adjustable hardware on the enclosure top and bottom. Phoenix\* connectors for input and link output are provided for convenience.



### You Are Covered

We always strive to provide the best possible Customer Experience. Our products are made in our own [MUSIC Tribe](#) factory using state-of-the-art automation, enhanced production workflows and quality assurance labs with the most sophisticated test equipment available in the world. As a result, we have one of the lowest product failure rates in the industry, and we confidently back it up with a generous [Warranty program](#).

Install

# DVS 6-WH

6" Coaxial Surface-Mount Loudspeaker for Installation Applications (White)

## Frequency Response Sensitivity 1 W / 1 m

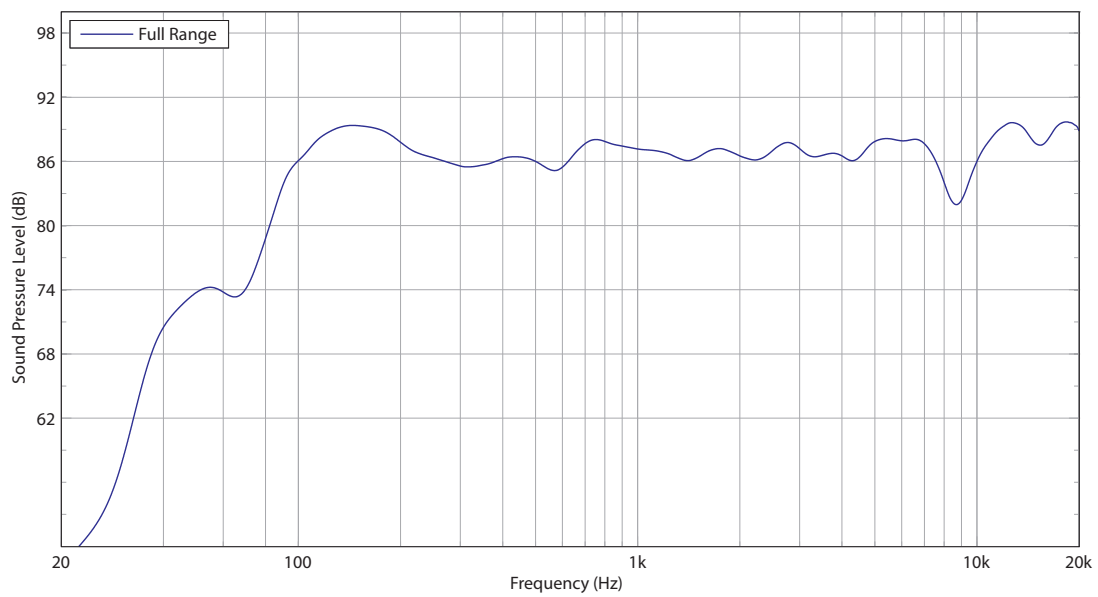

## Impedance

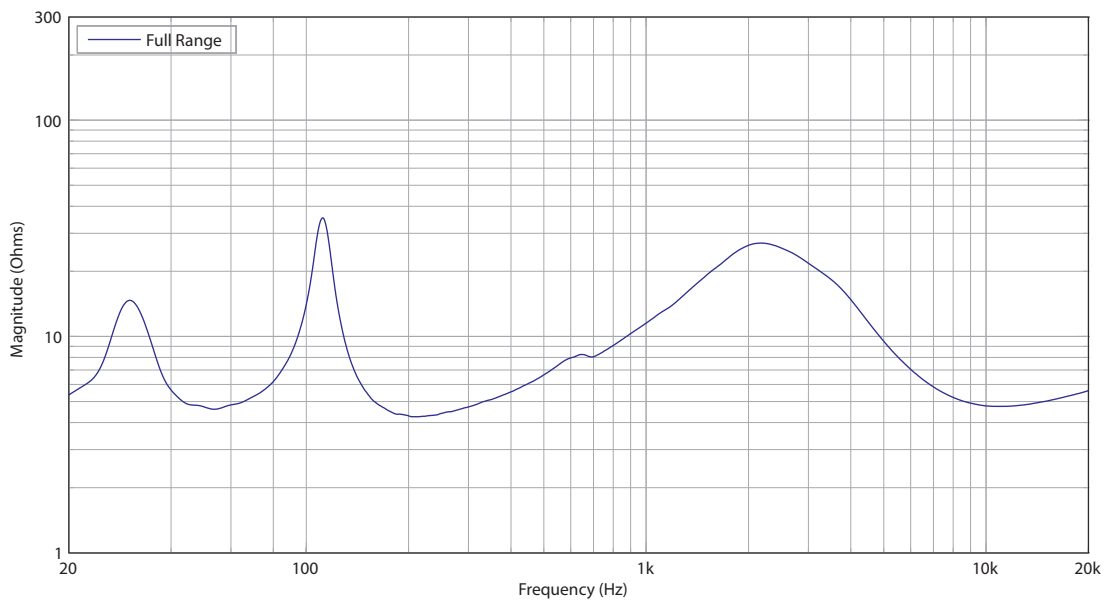

# DVS 6-WH

6" Coaxial Surface-Mount Loudspeaker for Installation Applications (White)

## Horizontal Beamwidth

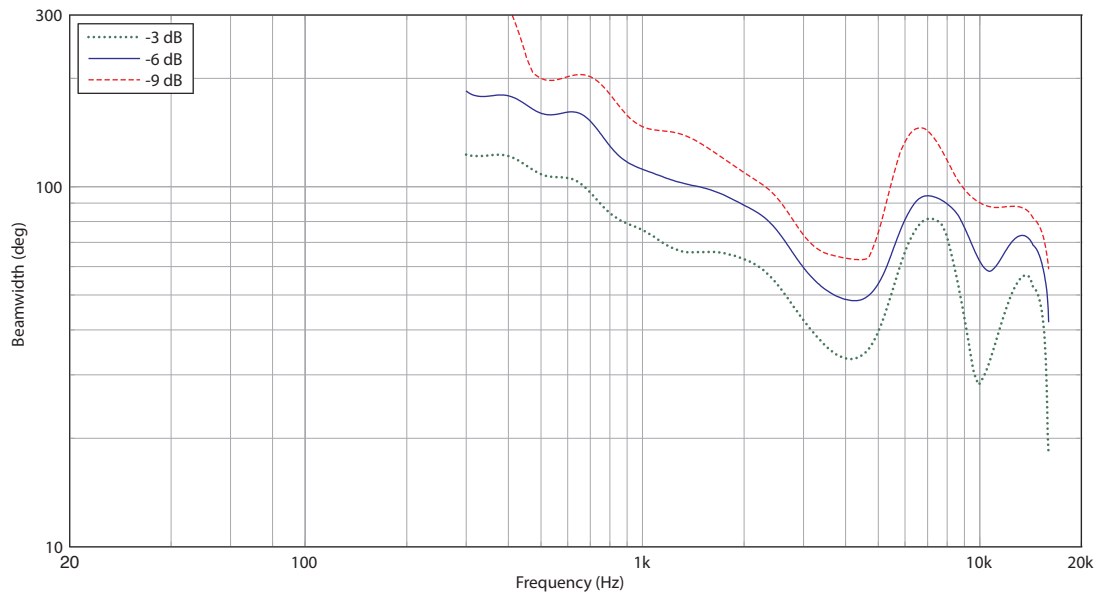

## Vertical Beamwidth

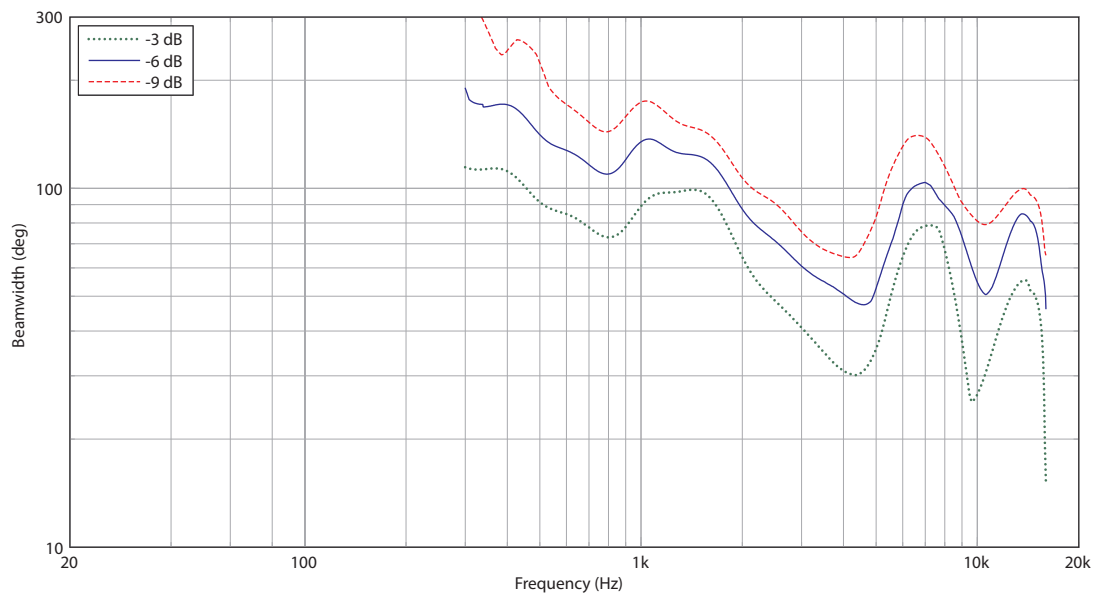

Install

# DVS 6-WH

6" Coaxial Surface-Mount Loudspeaker for Installation Applications (White)

## Horizontal Polar Plots

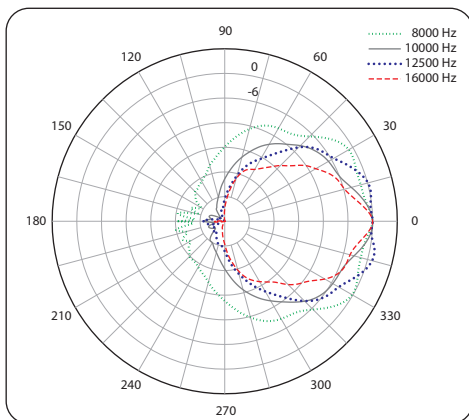
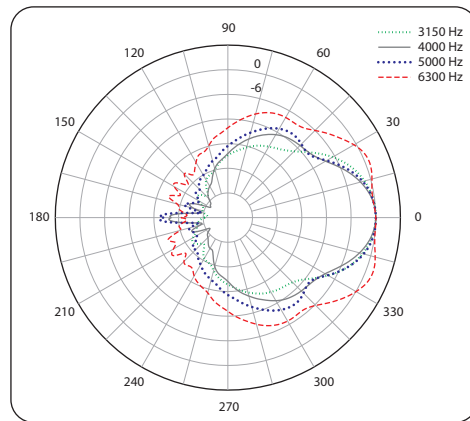
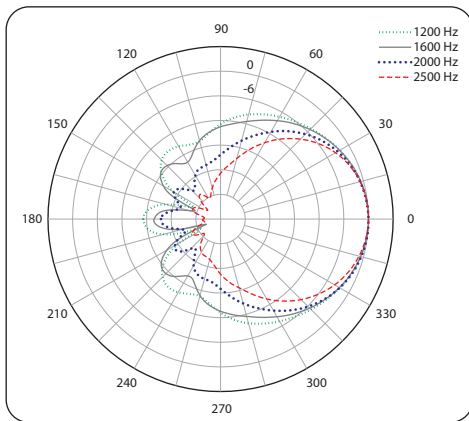
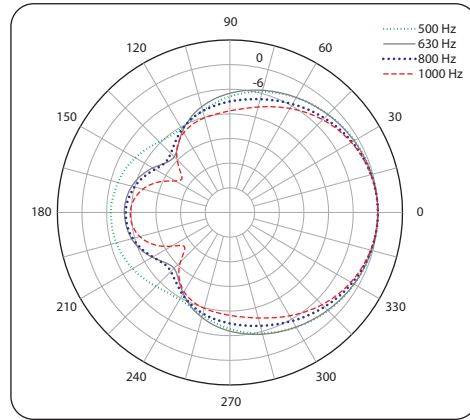
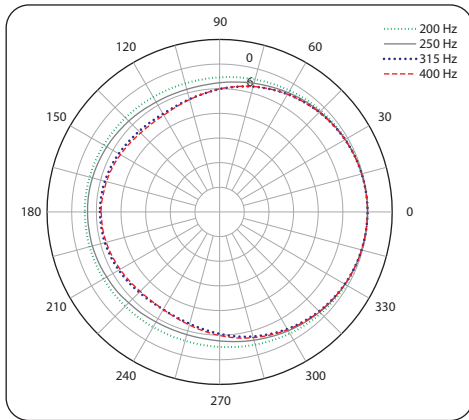

Install

# DVS 6-WH

6" Coaxial Surface-Mount Loudspeaker for Installation Applications (White)

## Vertical Polar Plots

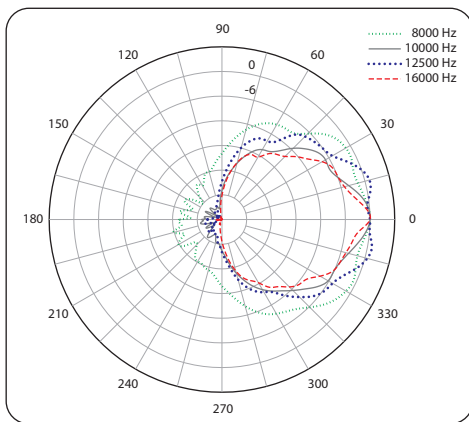
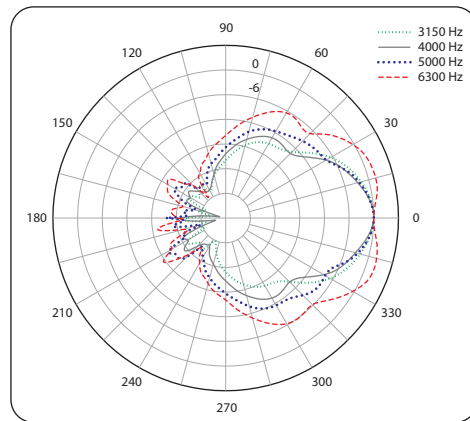
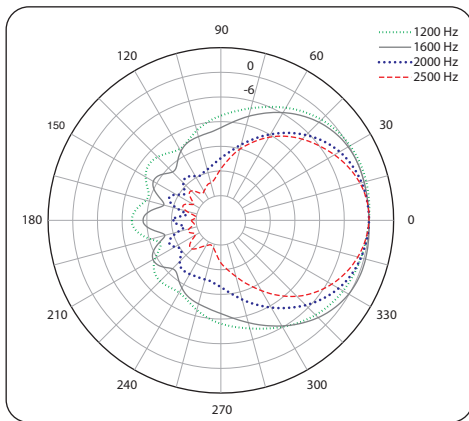
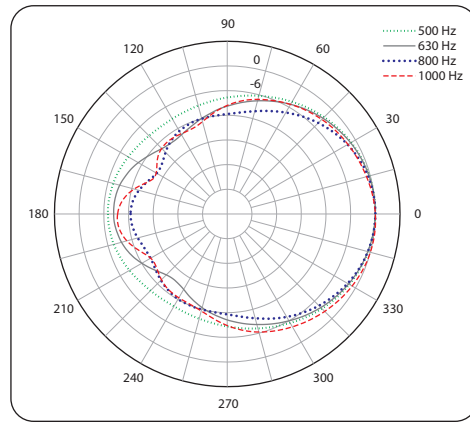
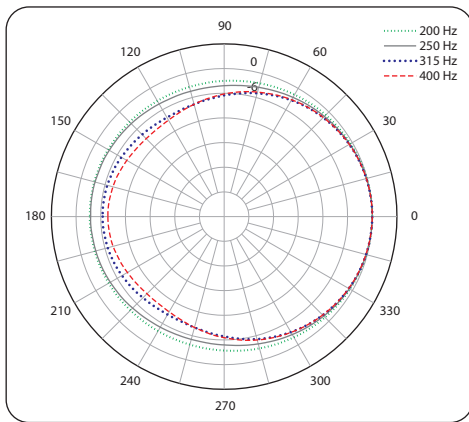

Install

# DVS 6-WH

6" Coaxial Surface-Mount Loudspeaker for Installation Applications (White)

## Dimensions

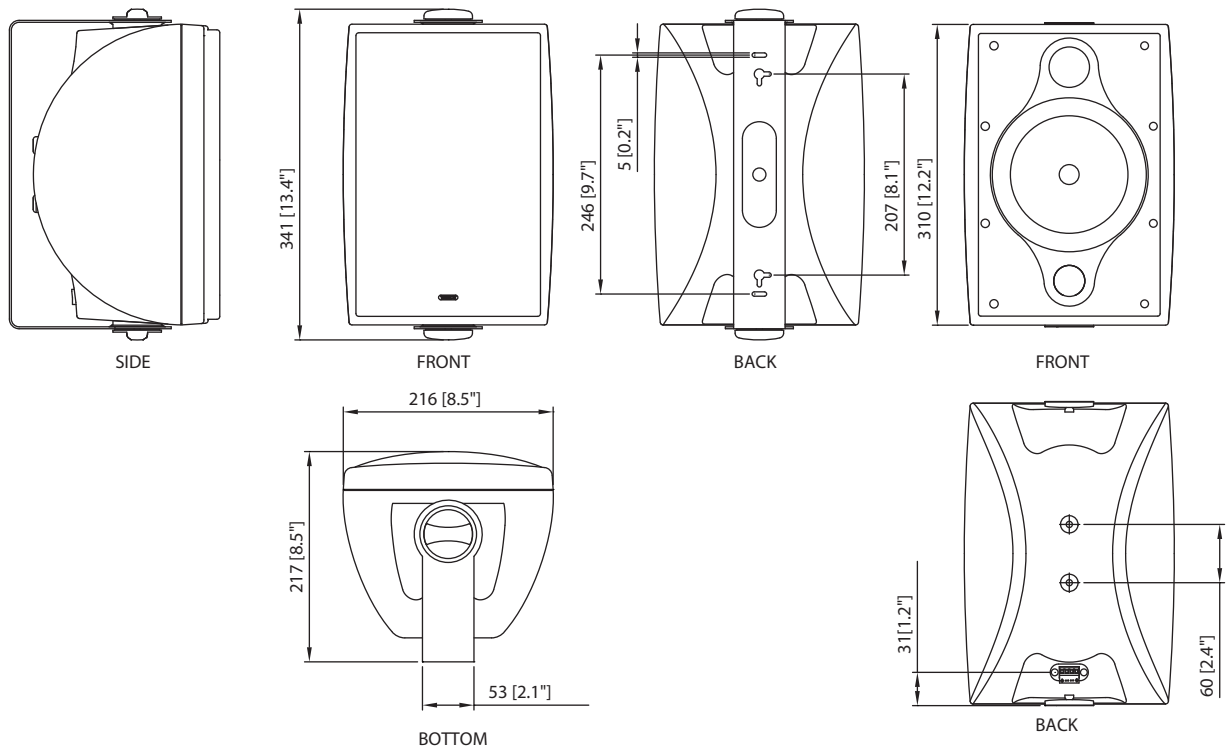

## Install

# DVS 6-WH

6" Coaxial Surface-Mount Loudspeaker for Installation Applications (White)

## Technical Specifications

### Performance

Frequency response (-3 dB) <sup>1</sup>	80 Hz - 20 kHz
Frequency response (-10 dB) <sup>1</sup>	65 Hz - 30k Hz
System sensitivity (1 W @ 1 m) <sup>2</sup>	88 dB
Dispersion (-6 dB)	90 degrees conical
Transducers	Coaxial
Low frequency	165mm (6.5") mineral loaded cone material
High frequency	20 mm (0.79)
Crossover	4.3 kHz - 2nd order LF, 2nd order HF
Directivity (Q)	10.6 averaged 1 kHz to 10 kHz
Directivity (DI)	9.6 averaged 1 kHz to 10 kHz
Rated maximum SPL <sup>2</sup>	105 dB (average) 111 dB (peak)

### Non Transformer Version

Maximum wire gauge for connector	2.5 mm CSA (AWG12)
Safety Agency Ratings	UL-1480, CE

### Power Handling

Average	60 W
Programme	120 W
Peak	240 W
Recommended amplifier power	120 W @ 6 Ohms
Nominal impedance	6 Ohms

### Construction

Enclosure	ABS
Grille	Aluminium, painted
Connectors	Euroblock type removable locking connector with screw terminals with "loop through" facility
Supplied accessories	Yoke bracket
Packed quantity	2
Dimensions (H x W x D)	340.5 x 212.2 x 216.5 mm (13.41 x 8.36 x 8.52")
<b>Non-transformer versions</b>	
Net weight	3.6 kg (8 lbs)
Shipped weight	8.9 kg (20 lbs)
<b>Transformer versions</b>	
Net weight	4.8 kg (10.6 lbs)
Shipped weight	11.3 kg (25 lbs)

#### Notes

(1) Average over stated bandwidth. Measured at 1 metre on axis in an anechoic chamber

(2) Unweighted pink noise input, measured at 1 metre in an anechoic chamber

A full range of measurements, performance data, and Ease Data can be downloaded from [www.tannoy.com](http://www.tannoy.com)

Tannoy operates a policy of continuous research and development. The introduction of new materials or manufacturing methods will always equal or exceed the published specifications, which Tannoy reserves the right to alter without prior notice. Please verify the latest specifications when dealing with critical applications.



Install

# DVS 6-WH

6" Coaxial Surface-Mount Loudspeaker for Installation Applications (White)



Install

# DVS 6-WH

6" Coaxial Surface-Mount Loudspeaker for Installation Applications (White)

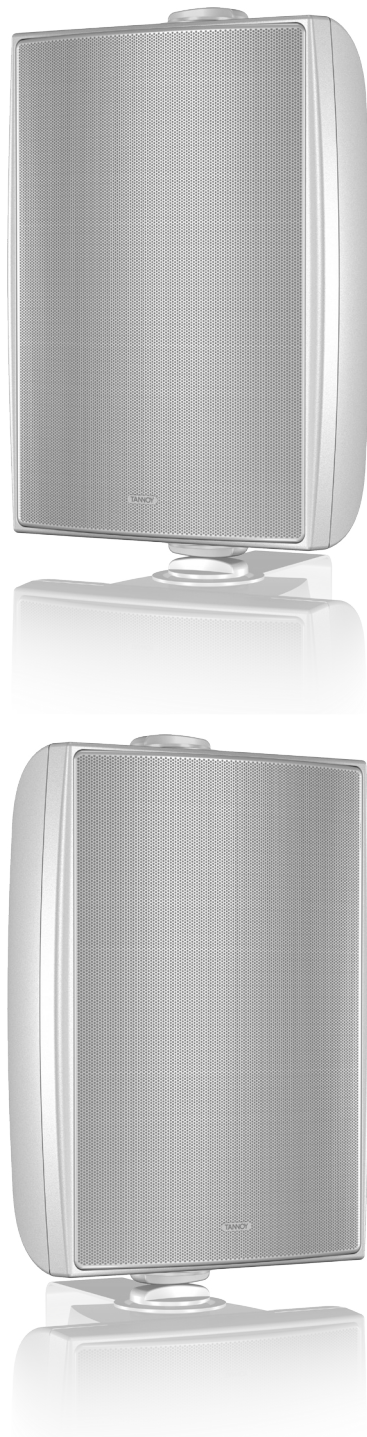

Install

# DVS 6-WH

6" Coaxial Surface-Mount Loudspeaker for Installation Applications (White)



Install

# DVS 6-WH

6" Coaxial Surface-Mount Loudspeaker for Installation Applications (White)



Install

# DVS 6-WH

6" Coaxial Surface-Mount Loudspeaker for Installation Applications (White)

SUSPENDING THIS SYSTEM SHOULD ONLY BE DONE BY QUALIFIED PERSONS FOLLOWING SAFE INSTALLATION STANDARDS

MADE IN CHINA

CE E

WIRING	PASSIVE
1+ / 2-	INPUT 6Ω
3- / 4+	LINK

**TANNOY**

DESIGNED AND ENGINEERED IN ENGLAND



For service, support or more information contact the TANNOY location nearest you:

**Europe**  
**MUSIC Tribe Brands UK Ltd.**  
Tel: +44156 273 2290  
Email: CARECrea@music-group.com  
CAREEnte@music-group.com  
CARELife@music-group.com

**USA/Canada**  
**MUSIC Tribe Commercial NV Inc.**  
Tel: +1 702.800 8290  
Email: CARECrea@music-group.com  
CAREEnte@music-group.com  
CARELife@music-group.com

**Japan**  
**MUSIC Tribe Services JP K.K.**  
Tel: +81 3 6231 0453  
Email: CARECrea@music-group.com  
CAREEnte@music-group.com  
CARELife@music-group.com

MUSIC Tribe accepts no liability for any loss which may be suffered by any person who relies either wholly or in part upon any description, photograph, or statement contained herein. Technical specifications, appearances and other information are subject to change without notice. All trademarks are the property of their respective owners. MIDAS, KLARK TEKNIK, LAB GRUPPEN, LAKE, TANNOY, TURBOSOUND, TC ELECTRONIC, TC HELICON, BEHRINGER, BUGERA and COOLAUDIO are trademarks or registered trademarks of MUSIC Tribe Global Brands Ltd. © MUSIC Tribe Global Brands Ltd. 2018 All rights reserved.

