

Install

DVS 8T

8" Coaxial Surface-Mount Loudspeaker with Transformer for Installation Applications

- Full range surface-mount loudspeaker for indoor and outdoor installation applications
- 70 Watts continuous, 280 Watts peak power
- 8" mineral loaded polypropylene driver with nitrile rubber surround for enhanced durability and long-term reliability
- 0.75" ferrofluid cooled soft dome neodymium high frequency driver
- 80° constant directivity dispersion for optimum coverage
- UL 1480 certified for general signalling systems
- UV and weather resistant UL 94 V-0 ABS enclosure
- Multiple transformer taps for 70 V and 100 V line systems
- Low insertion loss 60 W line transformer with easily accessible tapping switch
- All components weather resistant to IP64 for outdoor use
- Stylish durable enclosure in a semi matt black paint finish fits unobtrusively in any environment
- Painted perforated aluminium mesh grille with dust protection
- Yoke bracket included for ease of installation
- Phoenix* connectors input and link output
- 10-Year Warranty Program*
- Designed and engineered in the U.K.

Designed to excel in a wide variety of sound reinforcement applications, the full range DVS 8T is an ultra-compact 280-Watt surface mount loudspeaker that provides both exceptional value and inspiring acoustic performance. The DVS 8T is ideally suited for stereo or mono background/foreground music applications in theme parks, hotels, restaurants and bars, retail stores, as well as corporate AV, residential developments, and houses of worship.



Superb Point-Source Performance

DVS 8T's point-source design comprises a 200 mm (8.00") mid bass driver with a coaxially mounted 19 mm (0.75") high frequency section mounted in a stylish injection moulded ABS enclosure. Certified for water and dust ingress protection to IP64 standard, the DVS 8T is an exceptional choice for challenging environments such as indoor swimming pools, saunas, or work areas with unusually high levels of dust or moisture, and outdoor applications where weather conditions are moderate.

Install

DVS 8T

8" Coaxial Surface-Mount Loudspeaker with Transformer for Installation Applications

Attractive and Easy to Install

The highly durable and scuff resistant ABS enclosure features a black painted finish, and comes with an aesthetically pleasing aluminium grille. Installation is quick and easy, thanks to the included colour-matched steel mounting bracket and finger-adjustable hardware on the enclosure top and bottom. The DVS 8T is equipped with an internally mounted low insertion loss line transformer for 70 V or 100 V distributed sound applications. Wattage taps are configurable over a range of settings via a rotary tapping switch located on the back panel. Phoenix* connectors for input and link output are provided for convenience.



You Are Covered

We always strive to provide the best possible Customer Experience. Our products are made in our own [MUSIC Tribe](#) factory using state-of-the-art automation, enhanced production workflows and quality assurance labs with the most sophisticated test equipment available in the world. As a result, we have one of the lowest product failure rates in the industry, and we confidently back it up with a generous [Warranty program](#).

Install

DVS 8T

8" Coaxial Surface-Mount Loudspeaker with Transformer for Installation Applications

Frequency Response Sensitivity 1 W / 1 m

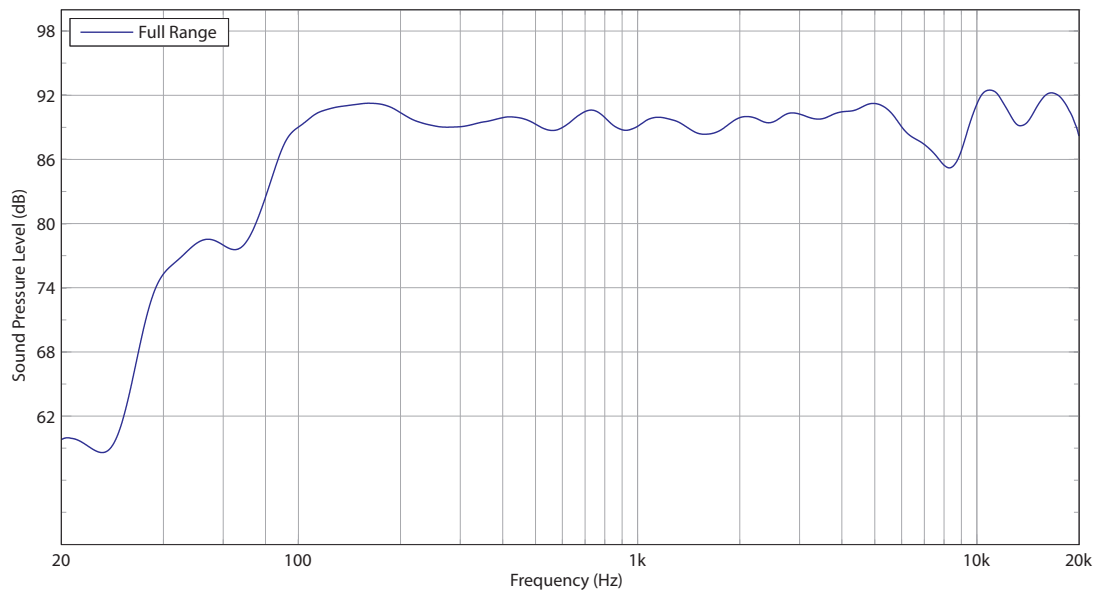

Impedance

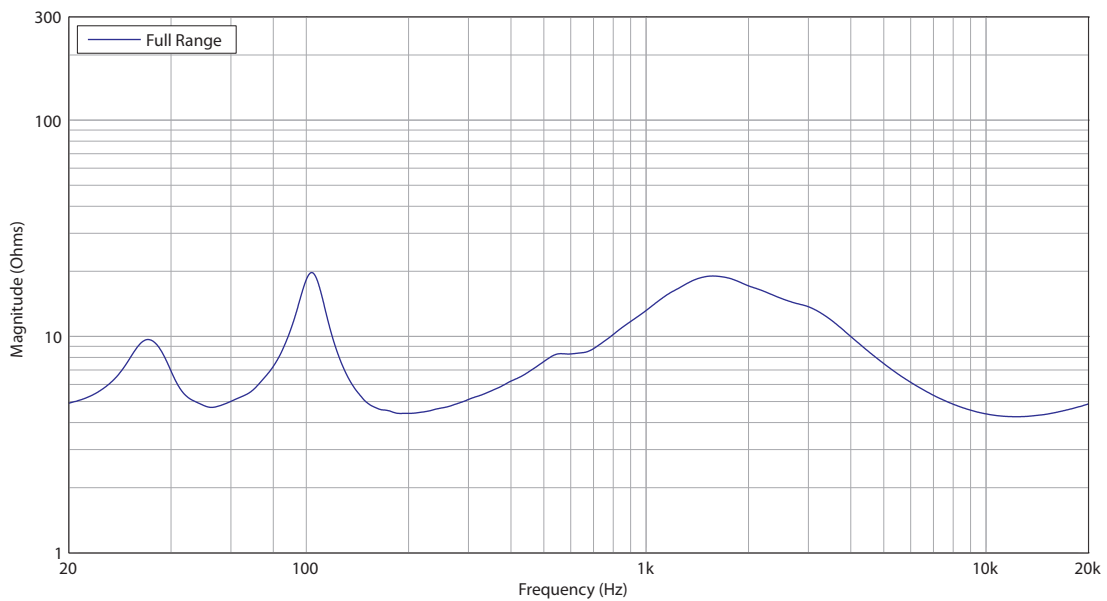

DVS 8T

8" Coaxial Surface-Mount Loudspeaker with Transformer for Installation Applications

Horizontal Beamwidth

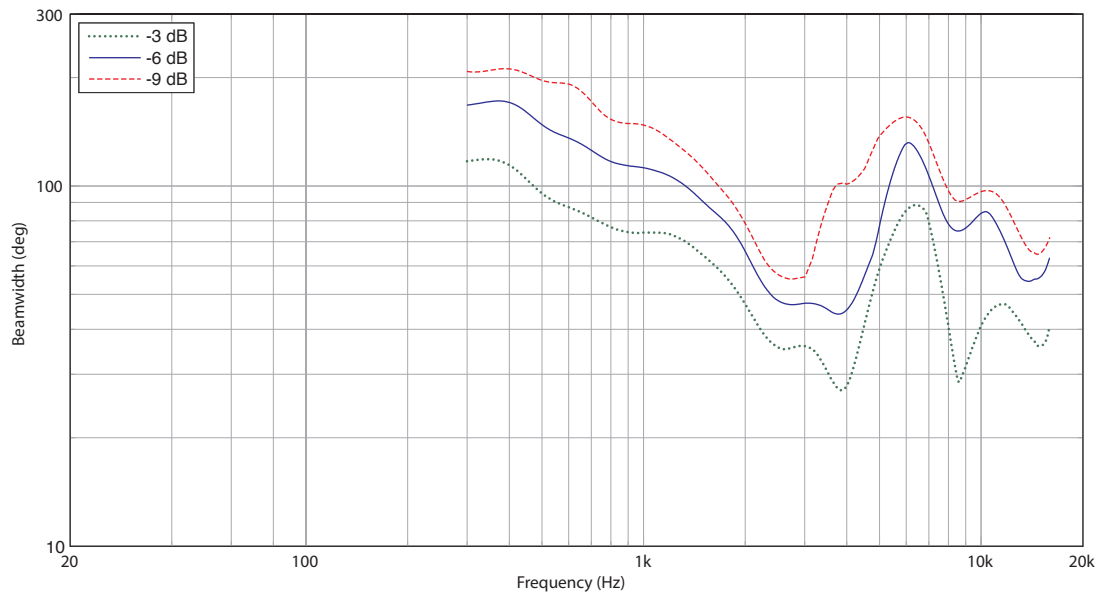

Vertical Beamwidth

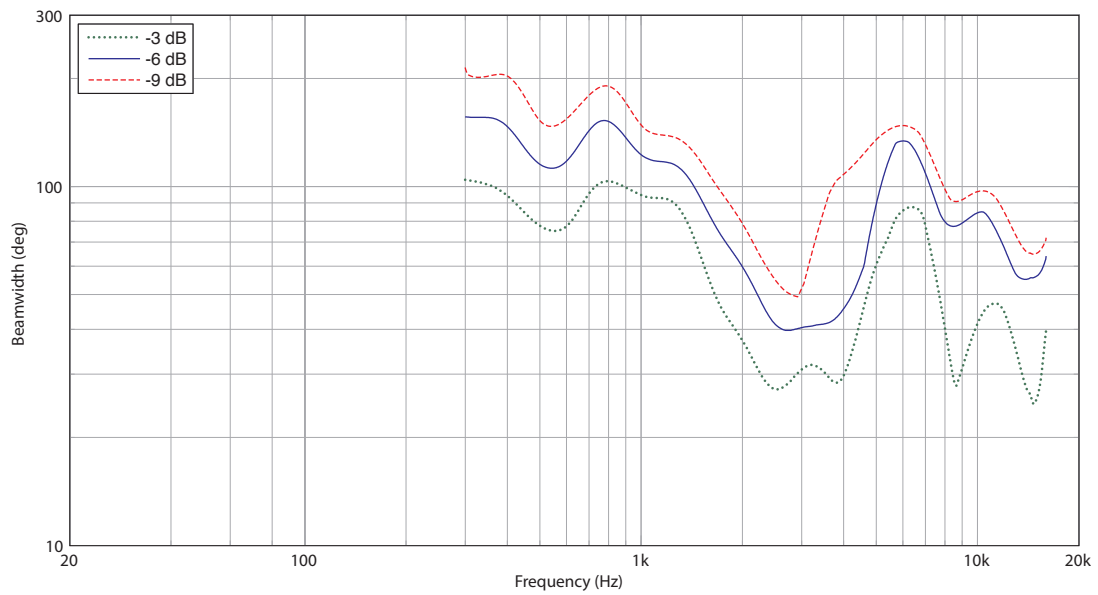

Install

DVS 8T

8" Coaxial Surface-Mount Loudspeaker with Transformer for Installation Applications

Horizontal Polar Plots

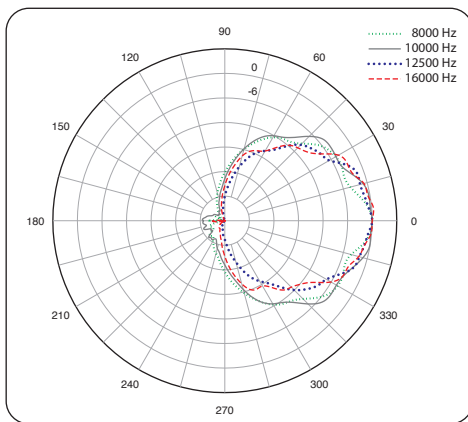
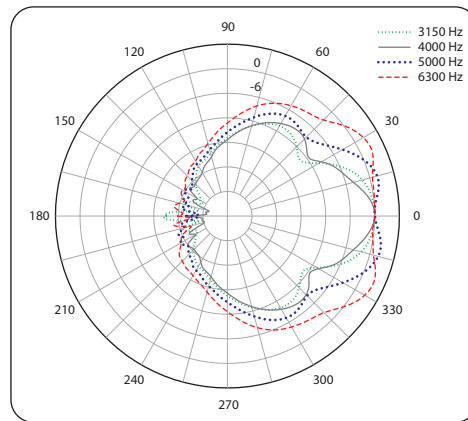
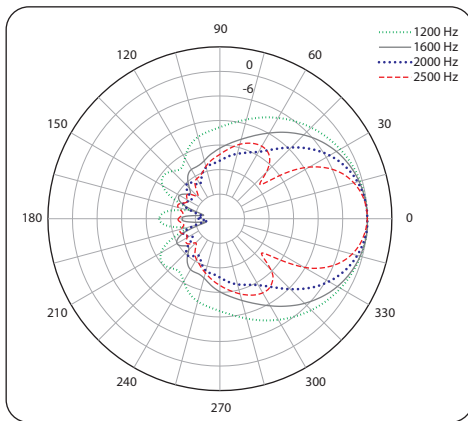
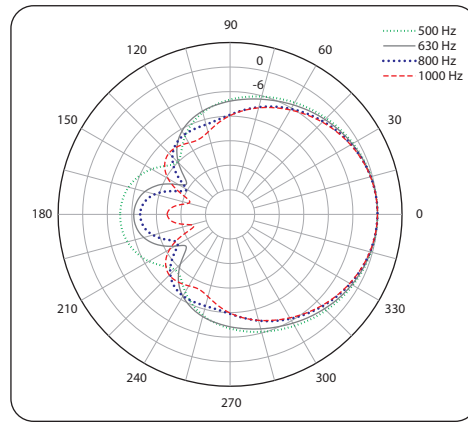
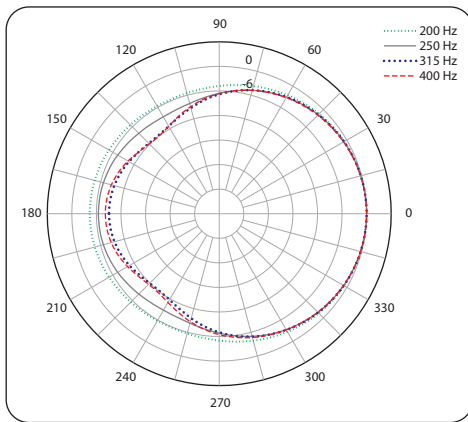

Install

DVS 8T

8" Coaxial Surface-Mount Loudspeaker with Transformer for Installation Applications

Vertical Polar Plots

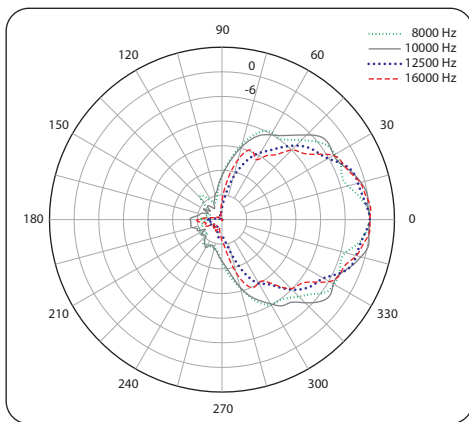
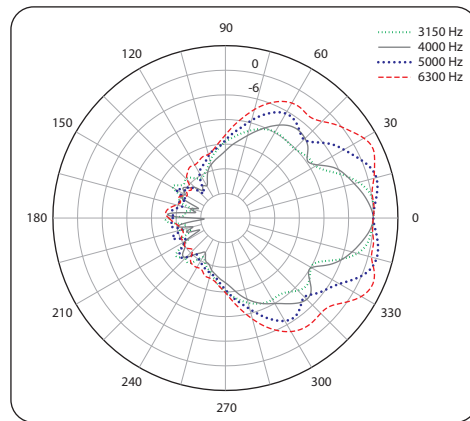
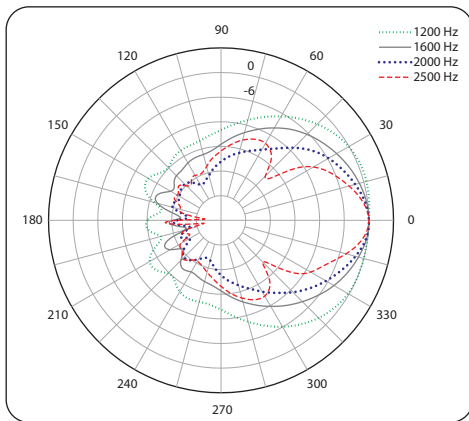
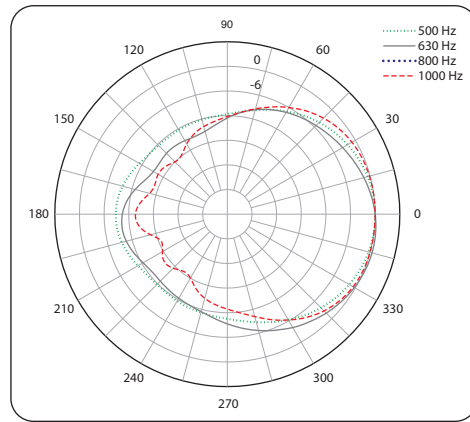
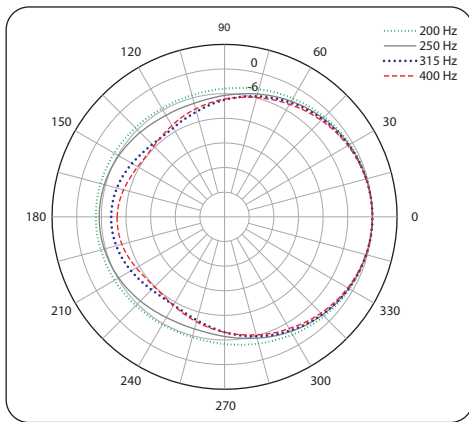

Install

DVS 8T

8" Coaxial Surface-Mount Loudspeaker with Transformer for Installation Applications

Dimensions

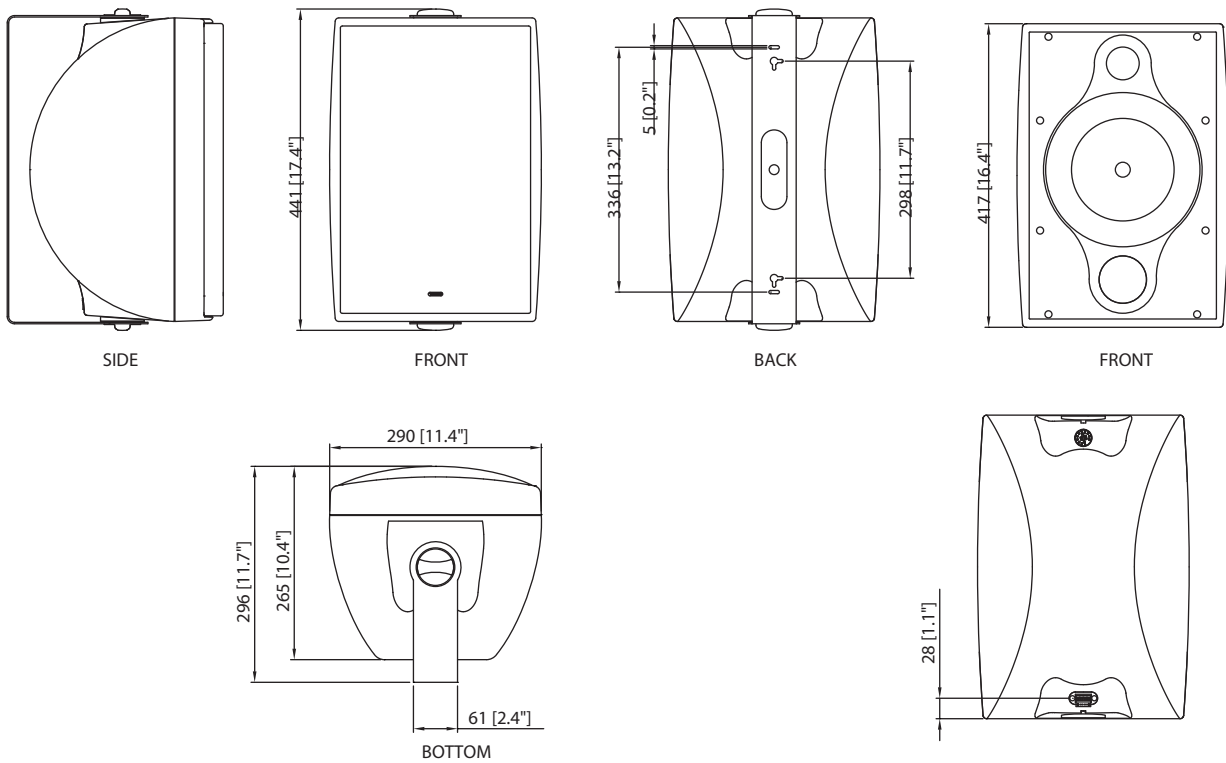

Install

DVS 8T

8" Coaxial Surface-Mount Loudspeaker with Transformer for Installation Applications

Technical Specifications

Performance

Frequency response (-3 dB) ¹	75 Hz - 20 kHz
Frequency response (-10 dB) ¹	60 Hz - 30 kHz
System sensitivity (1 W @ 1 m) ²	90 dB
Dispersion (-6 dB)	80 degrees conical
Transducers	Coaxial
Low frequency	200 mm (8.00") mineral loaded cone material
High frequency	20 mm (0.79)
Crossover	3.4 kHz - 2nd order LF, 2nd order HF
Directivity (Q)	12.3 averaged 1 kHz to 10 kHz
Directivity (DI)	10.0 averaged 1 kHz to 10 kHz
Rated maximum SPL ²	108 dB (average) 114 dB (peak)

Transformer Version

Transformer taps	
70 V	60 W (83 Ω) / 30 W (165 Ω) / 15 W (330 Ω) / 7.5 W (660 Ω) / OFF & low impedance operation
100 V	60 W (165 Ω) / 30 W (330 Ω) / 15 W (660 Ω) / OFF & low impedance operation
Maximum wire gauge for connector	2.5 mm CSA (AWG12)
Safety Agency Ratings	UL-1480, CE

Power Handling

Average	70 W
Programme	140 W
Peak	280 W
Recommended amplifier power	140 W @ 6 Ohms
Nominal impedance	6 Ohms

Construction

Enclosure	ABS
Grille	Aluminium, painted
Connectors	Euroblock type removable locking connector with screw terminals with "loop through" facility
Supplied accessories	Yoke bracket
Packed quantity	2
Dimensions (H x W x D)	451.8 x 290.0 x 296.0 mm (17.79 x 11.42 x 11.65")
Non-transformer versions	
Net weight	5.7 kg (12.6 lbs)
Shipped weight	14.5 kg (32 lbs)
Transformer versions	
Net weight	7 kg (15.4 lbs)
Shipped weight	17.1 kg (37.7 lbs)

Notes

- (1) Average over stated bandwidth. Measured at 1 metre on axis in an anechoic chamber
(2) Unweighted pink noise input, measured at 1 metre in an anechoic chamber

A full range of measurements, performance data, and Ease Data can be downloaded from www.tannoy.com

Tannoy operates a policy of continuous research and development. The introduction of new materials or manufacturing methods will always equal or exceed the published specifications, which Tannoy reserves the right to alter without prior notice. Please verify the latest specifications when dealing with critical applications.

Install

DVS 8T

8" Coaxial Surface-Mount Loudspeaker with Transformer for Installation Applications

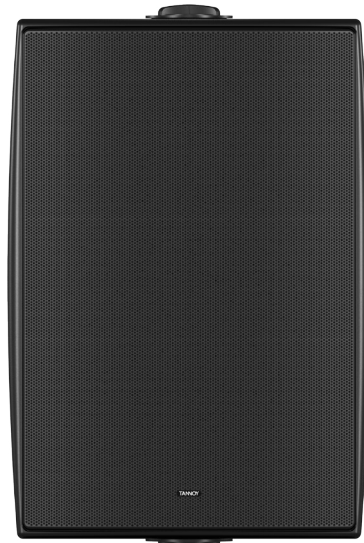

Install

DVS 8T

8" Coaxial Surface-Mount Loudspeaker with
Transformer for Installation Applications



Install

DVS 8T

8" Coaxial Surface-Mount Loudspeaker with
Transformer for Installation Applications



Install

DVS 8T

8" Coaxial Surface-Mount Loudspeaker with
Transformer for Installation Applications



Install

DVS 8T

8" Coaxial Surface-Mount Loudspeaker with Transformer for Installation Applications

SUSPENDING THIS SYSTEM SHOULD ONLY BE DONE BY QUALIFIED PERSONS FOLLOWING SAFE INSTALLATION STANDARDS



UL LISTED

Type:G
US 3PHS

MADE IN CHINA



DVS 8T

INPUT	POWER	WIRING	PASSIVE
70V LINE	7.5, 15, 30, 60 W	1+ / 2-	INPUT
100V LINE	15, 30, 60 W	3- / 4+	LINK
6 Ω	140 W PROGRAM	N/A	N/A

TANNOY

DESIGNED AND ENGINEERED IN ENGLAND



For service, support or more information contact the TANNOY location nearest you:

Europe
MUSIC Tribe Brands UK Ltd.
 Tel: +44156 273 2290
 Email: CARECrea@music-group.com
 CAREEnte@music-group.com
 CARELife@music-group.com

USA/Canada
MUSIC Tribe Commercial NV Inc.
 Tel: +1 702 800 8290
 Email: CARECrea@music-group.com
 CAREEnte@music-group.com
 CARELife@music-group.com

Japan
MUSIC Tribe Services JP K.K.
 Tel: +81 3 6231 0453
 Email: CARECrea@music-group.com
 CAREEnte@music-group.com
 CARELife@music-group.com

MUSIC Tribe accepts no liability for any loss which may be suffered by any person who relies either wholly or in part upon any description, photograph, or statement contained herein. Technical specifications, appearances and other information are subject to change without notice. All trademarks are the property of their respective owners. MIDAS, KLARK TEKNIK, LAB GRUPPEN, LAKE, TANNOY, TURBOSOUND, TC ELECTRONIC, TC HELICON, BEHRINGER, BUGERA and COOLAUDIO are trademarks or registered trademarks of MUSIC Tribe Global Brands Ltd. © MUSIC Tribe Global Brands Ltd. 2018 All rights reserved.

