

## Install

# OCV 8

## 8" Coaxial Pendant Loudspeaker for Installation Applications

- Coaxial full range pendant loudspeaker for installation applications
- 70 Watts continuous, 280 Watts peak power
- 8" mineral loaded polypropylene driver with nitrile rubber surround for enhanced durability and long-term reliability
- 1" ferrofluid cooled soft dome neodymium high frequency driver
- Wide constant directivity dispersion for optimum coverage
- UL 1480 certified for general signalling systems
- UV and weather resistant UL 94 V-0 ABS front with plated steel fire can enclosure
- Multiple transformer taps for 70 V and 100 V line systems or 16 Ohm direct input
- Low insertion loss 60 W line transformer with easily accessible tapping switch
- Optimised for LAB GRUPPEN low impedance LUCIA amplifiers with up to 8 OCV series loudspeakers per channel
- All components weather resistant to IP64 for outdoor use
- Semi matt black finish fits unobtrusively in any environment
- Powder coated perforated steel mesh grille with dust protection



The OCV 8 is a 280-Watt high sensitivity pendant loudspeaker that delivers wide and consistent broadband directivity with enhanced intelligibility – plus the linear response of our legendary studio monitors. Engineered specifically for aesthetically sensitive applications where consistent high quality audio coverage is required, the OCV 8 is ideally suited for airport and ground transportation terminals, shopping malls, and large double or triple height commercial floors – without compromising clarity, intelligibility or Sound Pressure Level (SPL). OCV 8 loudspeakers provide a seamless sound signature within a multi-zoned environment that benefits from additional [TANNOY](#) installation loudspeakers.



## Install

# OCV 8

## 8" Coaxial Pendant Loudspeaker for Installation Applications

- Quick and easy hanging system included for reduced installation time and cost
- Weatherproof cable gland cover to protect Phoenix\* connectors and tap selector switch
- 10-Year Warranty Program\*
- Designed and engineered in the U.K.

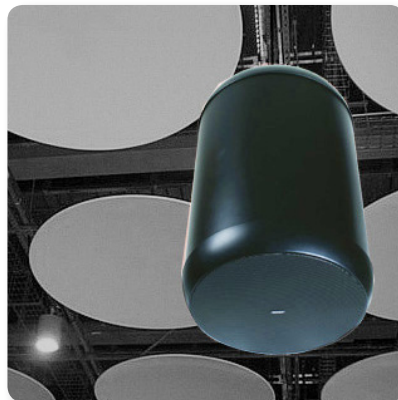

### Weather-Resistant Enclosure

The elegantly styled semi matt black cylindrical enclosure with mild steel powder coated grille blends beautifully into any décor – and comprises a 203 mm (8") polypropylene mid bass driver with a coaxially mounted 25 mm (1") ferrofluid cooled soft dome neodymium high frequency driver. Additionally, the OCV 8's design and performance has achieved an IP64 rating, making it an exceptional choice for both indoor and outdoor environments such as indoor swimming pools, saunas, or work areas with unusually high levels of dust or moisture, and outdoor applications where weather conditions are moderate.

### Attractive and Easy to Install

The highly durable and heat resistant plated steel enclosure features a black finish and comes with an aesthetically pleasing grille. Installation is quick and easy – and the included weatherproof cable gland protects the Phoenix\* input and link output connectors, as well as the integral low-insertion loss 60 W transformer with convenient tap switching.



\*All third-party trademarks are the property of their respective owners. Their use neither constitutes a claim of the trademark nor affiliation of the trademark owners with MUSIC Tribe. Product names are mentioned solely as a reference for compatibility, effects and/or components. Warranty details can be found at musictribe.be.

## Install

# OCV 8

8" Coaxial Pendant Loudspeaker for Installation Applications



### LAB GRUPPEN Ready

The OCV 8 is optimised for use with [LAB GRUPPEN LUCIA](#) amplifiers, which accommodate up to 8 OCV Series loudspeakers per channel.

### You Are Covered

We always strive to provide the best possible Customer Experience. Our products are made in our own MUSIC Tribe factory using state-of-the-art automation, enhanced production workflows and quality assurance labs with the most sophisticated test equipment available in the world. As a result, we have one of the lowest product failure rates in the industry, and we confidently back it up with a generous Warranty program.



Install

# OCV 8

8" Coaxial Pendant Loudspeaker for Installation Applications

## Frequency Response Sensitivity 1 W / 1 m

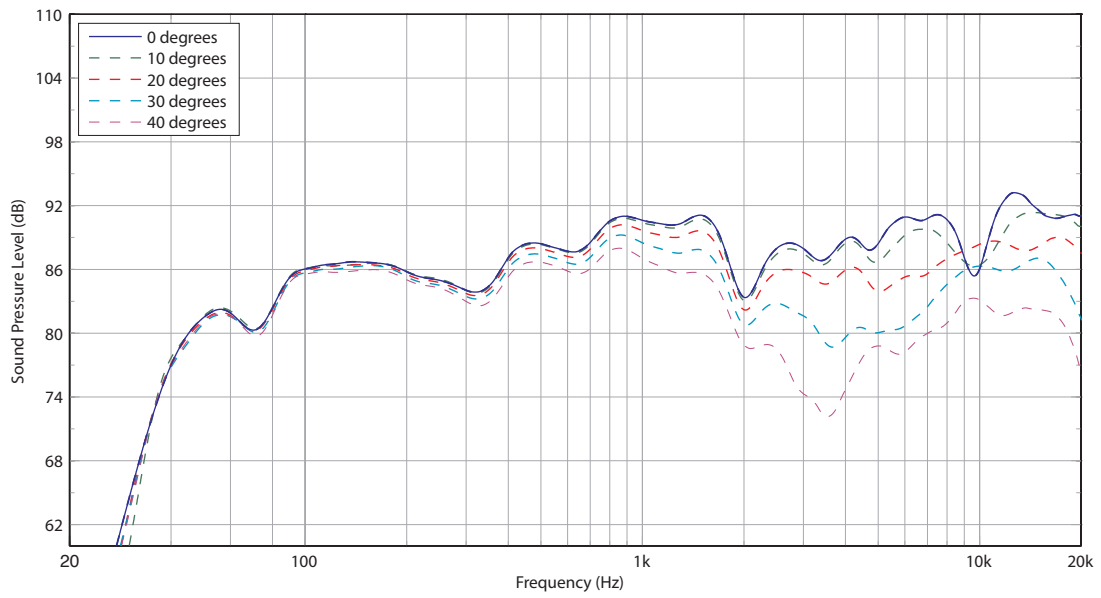

## Impedance

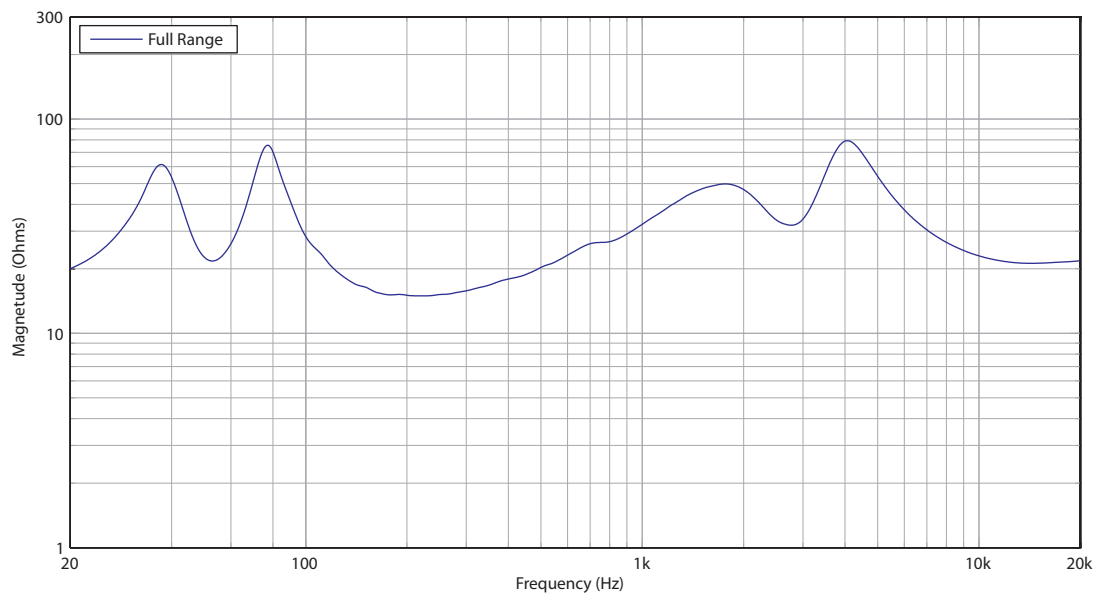

# OCV 8

8" Coaxial Pendant Loudspeaker for Installation Applications

## Horizontal Beamwidth

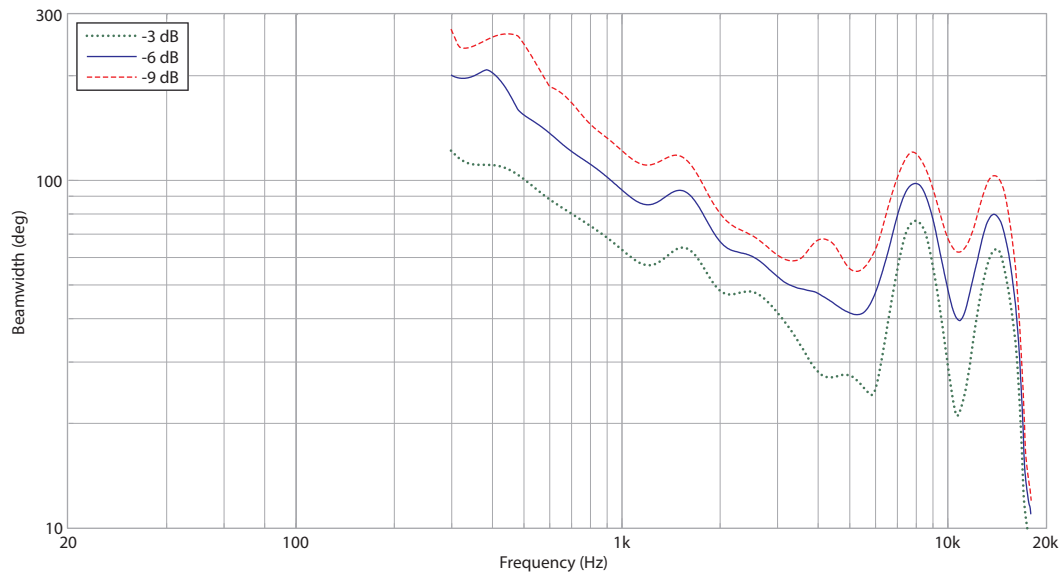

Install

# OCV 8

8" Coaxial Pendant Loudspeaker for Installation Applications

## Polar Plots

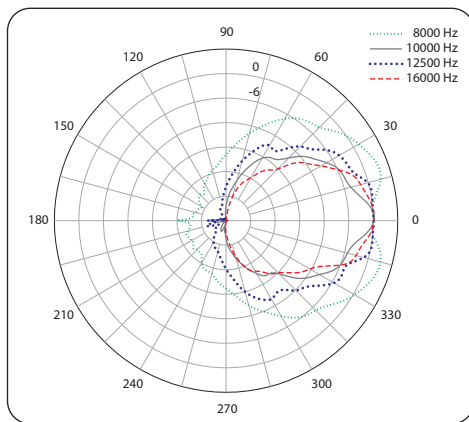
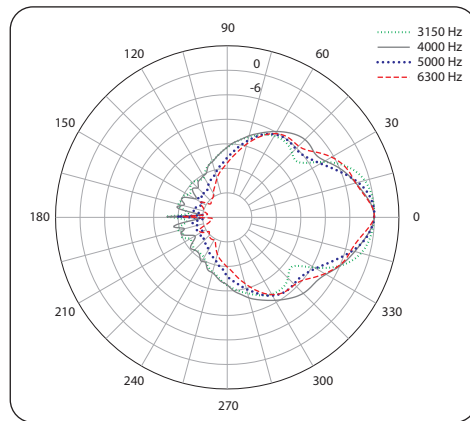
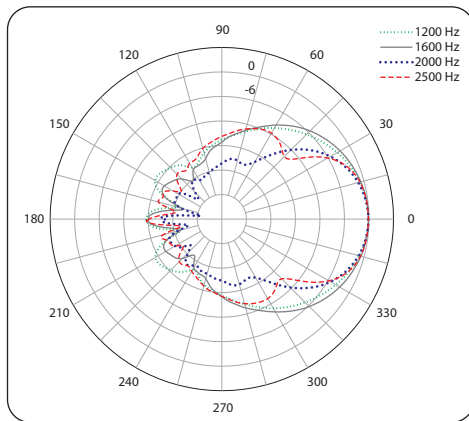
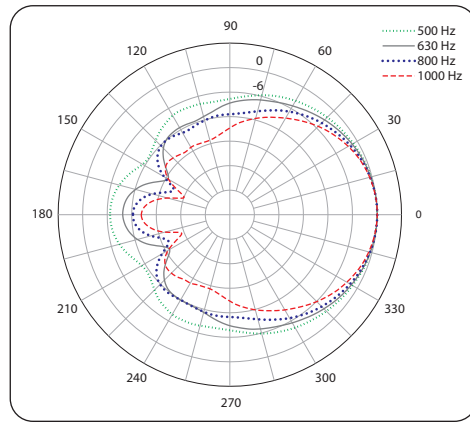
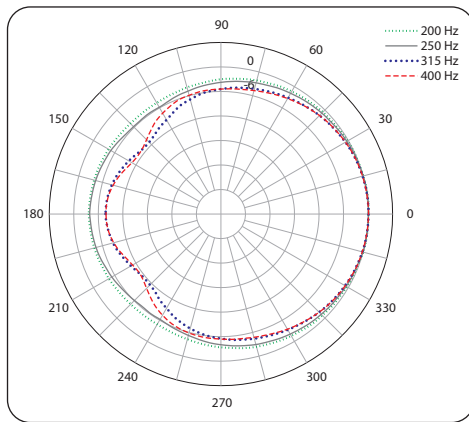

Install

# OCV 8

8" Coaxial Pendant Loudspeaker for Installation Applications

## Dimensions

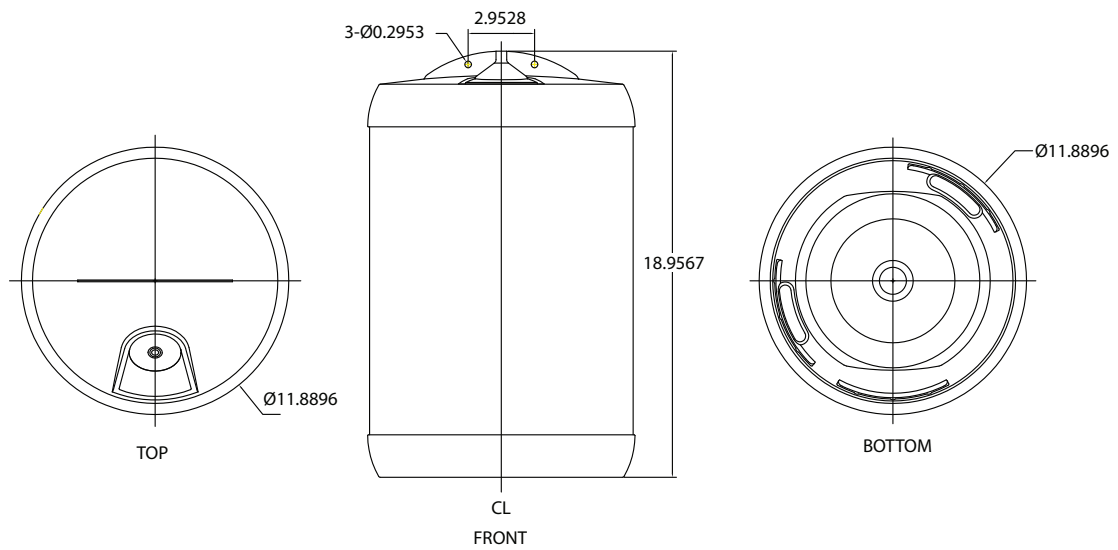

## Install

# OCV 8

8" Coaxial Pendant Loudspeaker for  
Installation Applications

## Technical Specifications

### Performance

Frequency Response (-3 dB) <sup>(1)</sup>	75 Hz - 20 kHz
Frequency Range (-10 dB) <sup>(1)</sup>	60 Hz - 30 kHz
System Sensitivity (1 W @1 m) <sup>(2)</sup>	90 dB
Dispersion (-6 dB)	80 degrees conical
Transducers	Coaxial
Low Frequency	200 mm (8.00") mineral loaded cone material
High Frequency	25 mm (1.00")
Crossover	4.5 kHz - 3rd order LF, 2d order HF
Directivity (Q)	14.4 averaged 1 kHz to 6.3 kHz
Directivity (DI)	11.6 dB averaged 1 kHz to 6.3 kHz
Rated Maximum SPL <sup>(2)</sup>	108 dB (average) 114 dB (peak)
<b>Power Handling</b>	
Average	70 W
Programme	140 W
Peak	280 W
Recommended Amplifier Power	140 W @ 16 Ω
Nominal Impedance	16 Ω

### Construction

Enclosure	ABS / Steel
Grille	Steel, plated and powder coat painted
Connectors	Euroblock type removable locking connector with screw terminals with "loop through" facility
Transformer setting	Rotary switch
Safety Agency Ratings	UL-1480, UL-2043, CE
Bezel diameter	302 mm (11.9")
Overall Length	493 mm (19.4")
Net Weight	8.2 kg (18.1 lbs)
Shipped weight	10.4 kg (22.9 lbs)
<b>Transformer Taps</b>	
70 V	60 W / 30 W / 15 W / 7.5 W & low Impedance operation
100 V	60 W / 30 W / 15 W & low Impedance operation

#### Notes:

1. Average over stated bandwidth. Measured at 1 metre on axis in an anechoic chamber

2 Unweighted pink noise input, measured at 1 metre in an anechoic chamber

A full range of measurements, performance data, and Ease Data can be downloaded from [www.tannoy.com](http://www.tannoy.com)



Install

# OCV 8

8" Coaxial Pendant Loudspeaker for  
Installation Applications



Install

# OCV 8

8" Coaxial Pendant Loudspeaker for  
Installation Applications



Install

# OCV 8

8" Coaxial Pendant Loudspeaker for  
Installation Applications



Install

# OCV 8

8" Coaxial Pendant Loudspeaker for  
Installation Applications



Install

# OCV 8

8" Coaxial Pendant Loudspeaker for Installation Applications

SUSPENDING THIS SYSTEM SHOULD ONLY BE DONE BY QUALIFIED PERSONS FOLLOWING SAFE INSTALLATION STANDARDS



Type:G  
US 3PHS

MADE IN CHINA



### SPEAKER: OCV 8

INPUT	POWER	WIRING	PASSIVE
70V LINE	7.5, 15, 30, 60 W	1+ / 2-	INPUT
100V LINE	15, 30, 60 W	3- / 4+	LINK
16Ω	140W PROGRAM	N/A	N/A

REFER TO INSTALLATION WIRING DIAGRAM IN QUICK START GUIDE

## TANNOY

DESIGNED AND ENGINEERED IN THE U.K.



For service, support or more information contact the TANNOY location nearest you:

**Europe**  
**MUSIC Tribe Brands UK Ltd.**  
 Tel: +44156 273 2290  
 Email: CARECrea@music-group.com  
 CAREEnte@music-group.com  
 CARELife@music-group.com

**USA/Canada**  
**MUSIC Tribe Commercial NV Inc.**  
 Tel: +1 702 800 8290  
 Email: CARECrea@music-group.com  
 CAREEnte@music-group.com  
 CARELife@music-group.com

**Japan**  
**MUSIC Tribe Services JP K.K.**  
 Tel: +81 3 6231 0453  
 Email: CARECrea@music-group.com  
 CAREEnte@music-group.com  
 CARELife@music-group.com

MUSIC Tribe accepts no liability for any loss which may be suffered by any person who relies either wholly or in part upon any description, photograph, or statement contained herein. Technical specifications, appearances and other information are subject to change without notice. All trademarks are the property of their respective owners. MIDAS, KLARK TEKNIK, LAB GRUPPEN, LAKE, TANNOY, TURBOSOUND, TC ELECTRONIC, TC HELICON, BEHRINGER, BUGERA and COOLAUDIO are trademarks or registered trademarks of MUSIC Tribe Global Brands Ltd. © MUSIC Tribe Global Brands Ltd. 2018 All rights reserved.

