

Install

VSX118B

18" Direct Radiating Passive Subwoofer for Portable and Installation Applications



- Compact direct radiating subwoofer for portable and installation applications
- 1,000 Watts continuous, 4,000 Watts peak power
- 18" driver for extended low frequency response to below 40 Hz
- Low distortion dual port design for maximum sound pressure levels
- Ideal for background music playback in clubs, bars, theatres and AV applications
- Internally braced plywood enclosure
- Finished with a hard wearing semi matt black paint finish
- Rugged powder coated perforated steel mesh grille
- Blanking plate for optional VTH pole mount
- Integral M10 rigging points for ease of installation
- Integrip handles ergonomically integrated into top of cabinet
- Neutrik speakON* NL4 and barrier strip connectors for input and link output
- 10-Year Warranty Program*
- Designed and engineered in the U.K.

The 4,000-Watt VSX118B is a direct radiating passive 18" subwoofer that is ideally suited for a broad range of speech and music sound reinforcement applications in both fixed, portable, and touring audio systems. VSX118B's superb low frequency reproduction makes it the perfect choice for deployment in clubs, bars, theatres and AV applications.



Stunning Performance

A ported bass reflex system, the VSX118B features a high powered 18" low frequency driver that provides extended low frequency response to well below 40 Hz – for chest-pounding bass. Fast and accurate transient response enables the VSX118B subwoofer to generate copious quantities of tight low end output that is virtually distortion-free.

Install

VSX118B

18" Direct Radiating Passive Subwoofer for Portable and Installation Applications

Versatility

VSX118B Subwoofers can be easily deployed in a multitude of configurations, thanks to the integral M10 rigging points and blanking plate for an optional VTH pole mount. For touring and portable applications, the enclosures also feature our Integrip handles, which are ergonomically integrated into the top of each cabinet.

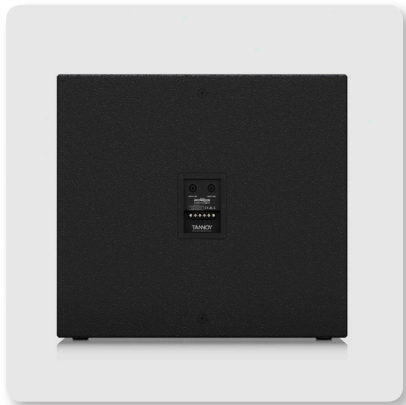
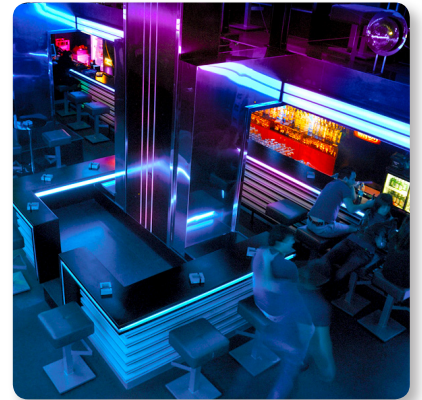

Construction and Connectivity

Finished in a hard wearing semi matt black paint, the cabinet is constructed of internally braced plywood and includes a rugged powder coated perforated steel mesh grille backed with reticulated foam. The rear panel connector plate carries Neutrik speakON* NL4 and barrier strip connectors for input and link connections to accommodate additional subwoofer, or satellite full range loudspeakers.

You Are Covered

We always strive to provide the best possible Customer Experience. Our products are made in our own [MUSIC Tribe](#) factory using state-of-the-art automation, enhanced production workflows and quality assurance labs with the most sophisticated test equipment available in the world. As a result, we have one of the lowest product failure rates in the industry, and we confidently back it up with a generous [Warranty program](#).



Install

VSX118B

18" Direct Radiating Passive Subwoofer for Portable and Installation Applications

Frequency Response Sensitivity 1 W / 1 m

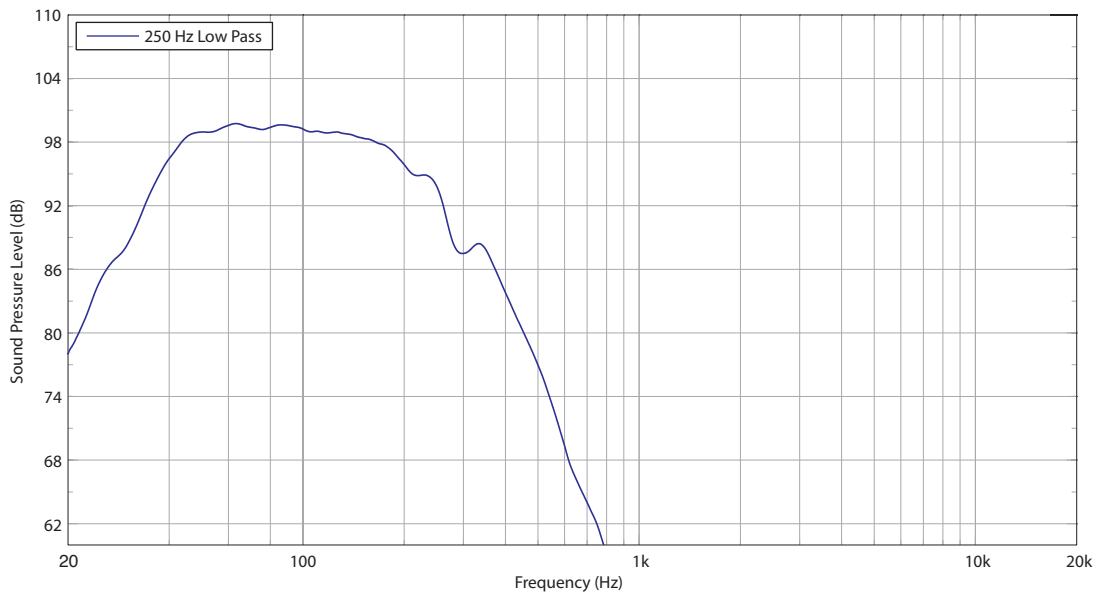

Impedance

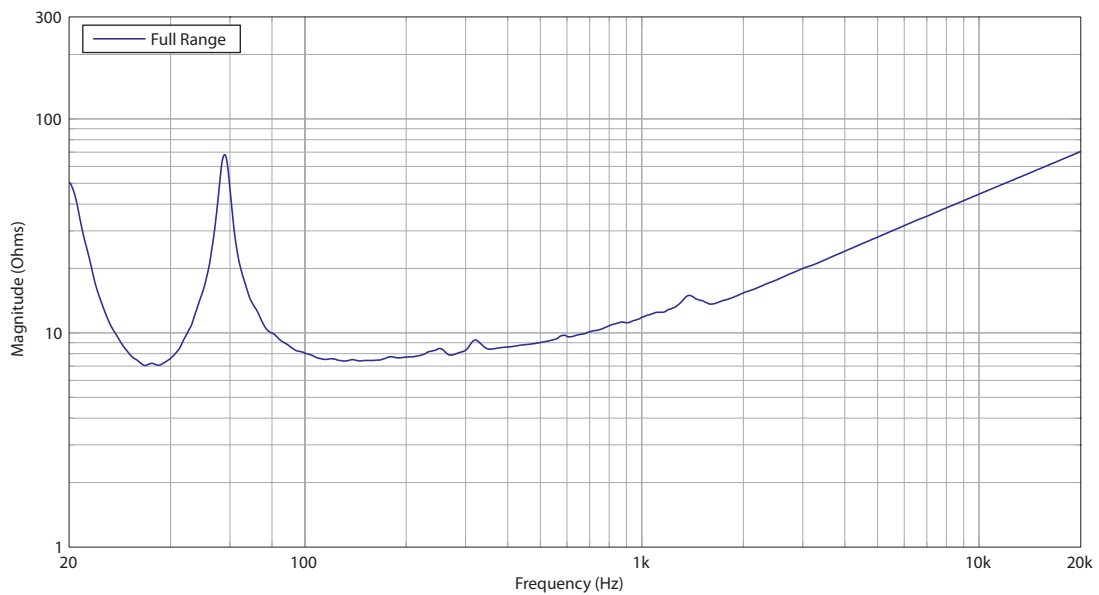

Install

VSX118B

18" Direct Radiating Passive Subwoofer for Portable and Installation Applications

Dimensions

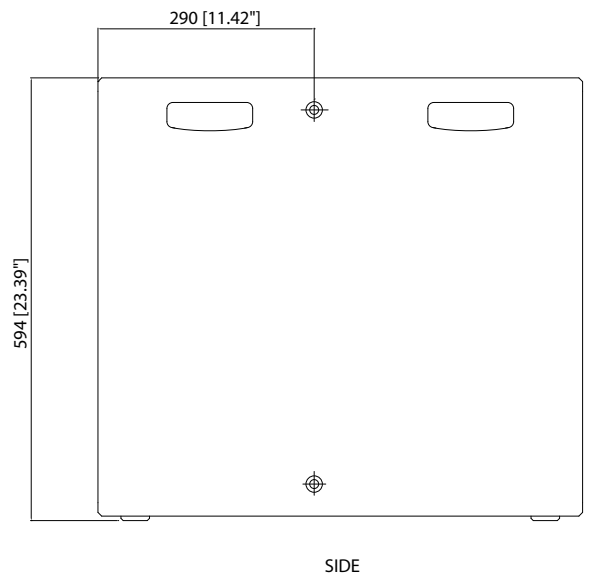
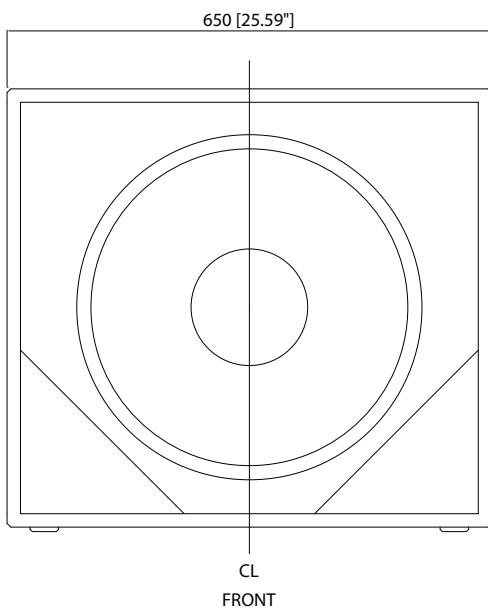
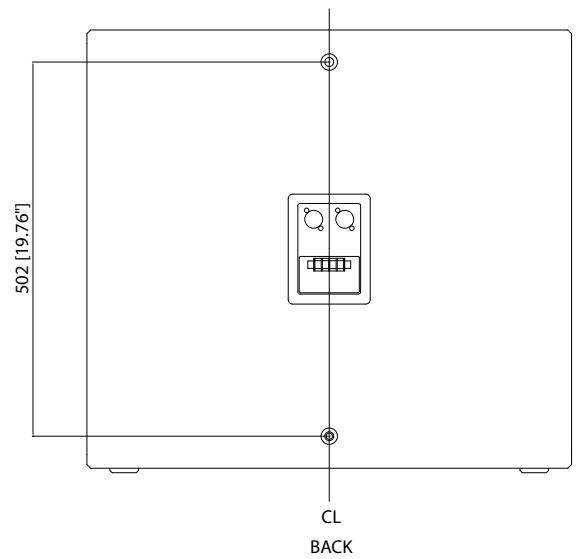
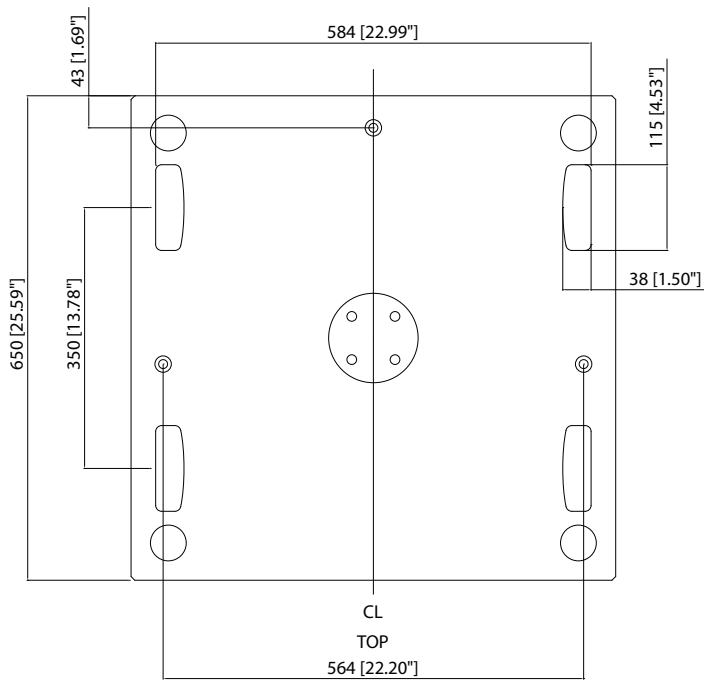

Install

VSX118B

18" Direct Radiating Passive Subwoofer for
Portable and Installation Applications

Technical Specifications

System

Frequency response	40 Hz – 3 kHz, ± 3 dB 32 Hz – 4 kHz, -10 dB
Recommended low pass crossover	80 – 300 Hz, 24 dB/Oct
Nominal dispersion	Half space
Power handling (IEC)	1000 W continuous, 4000 W peak
Sensitivity	99 dB (1 W @ 1 m)
Maximum SPL	129 dB continuous, 135 dB peak
Impedance	8 Ω
Components	1 x 18" (460 mm) LF driver

Enclosure

Connectors	2 x Neutrik speakON* NL4 1 x barrier strip terminals
Wiring Parallel	Pins 1+ / 1- input, pins 2+ / 2- link —
Discrete	—
Dimensions H x W x D	594 x 650 x 650 mm (23.4 x 25.6 x 25.6")
Net weight	43.1 kg (94.9 lbs)
Construction	18 mm (¾") plywood
Finish	Semi matt black paint (white optional)
Grille	Powder coated perforated steel
Flying hardware	M10 x 12 points

Accessories

Blanking plate for optional VTH pole mount

Install

VSX118B

18" Direct Radiating Passive Subwoofer for
Portable and Installation Applications



Install

VSX118B

18" Direct Radiating Passive Subwoofer for
Portable and Installation Applications



Install

VSX118B

18" Direct Radiating Passive Subwoofer for
Portable and Installation Applications



Install

VSX118B

18" Direct Radiating Passive Subwoofer for
Portable and Installation Applications



Install

VSX118B

18" Direct Radiating Passive Subwoofer for Portable and Installation Applications



For service, support or more information contact the TANNOY location nearest you:

Europe
MUSIC Tribe Brands UK Ltd.
 Tel: +44156 273 2290
 Email: CARECrea@music-group.com
 CAREEnte@music-group.com
 CARELife@music-group.com

USA/Canada
MUSIC Tribe Commercial NV Inc.
 Tel: +1 702 800 8290
 Email: CARECrea@music-group.com
 CAREEnte@music-group.com
 CARELife@music-group.com

Japan
MUSIC Tribe Services JP K.K.
 Tel: +81 3 6231 0453
 Email: CARECrea@music-group.com
 CAREEnte@music-group.com
 CARELife@music-group.com

MUSIC Tribe accepts no liability for any loss which may be suffered by any person who relies either wholly or in part upon any description, photograph, or statement contained herein. Technical specifications, appearances and other information are subject to change without notice. All trademarks are the property of their respective owners. MIDAS, KLARK TEKNIK, LAB GRUPPEN, LAKE, TANNNOY, TURBOSOUND, TC ELECTRONIC, TC HELICON, BEHRINGER, BUGERA and COOLAUDIO are trademarks or registered trademarks of MUSIC Tribe Global Brands Ltd. © MUSIC Tribe Global Brands Ltd. 2018 All rights reserved.

TANNOY