

## Install

# VXP 8

1,600 Watt 8" Dual Concentric Powered Sound Reinforcement Loudspeaker with Integrated LAB GRUPPEN IDEEA Class-D Amplification

- Full range multi-purpose powered sound reinforcement loudspeaker for portable and installation applications
- 1,600 Watt power featuring LAB GRUPPEN IDEEA electronics Class-D amplification
- 8" Dual Concentric full range driver for point source phase coherence
- Tightly controlled 90° dispersion for optimum coverage and forward projection
- Ideal for FOH, floor monitor, delay and stage front fill applications
- Switchable full range or high pass filter operation
- Vented and internally braced plywood enclosure
- Finished with hard wearing semi matt black paint
- Rugged powder coated perforated steel mesh grille
- Blanking plate for optional VTH pole mount
- Versatile mounting via optional custom designed hardware
- Fully balanced input and link output on Neutrik\* XLR connectors
- Neutrik powerCON\* for a secure locking mains power connection
- 10-Year Warranty Program\*
- Designed and engineered in the U.K.

The VXP 8 may be one of the smaller Dual Concentric full range loudspeakers in the VXP range, but it boasts an exceptional performance-to-size ratio – plus includes LAB GRUPPEN IDEEA Class-D amplification. VXP 8 provides a compact, yet punchy and sonically articulate solution for small-scale performance sound reinforcement, as well as more demanding background music and high-intelligibility speech applications where clarity and natural vocal reproduction are paramount. The VXP 8 is also ideally suited for use complimenting much larger systems, making it an excellent choice for both installed and portable applications.

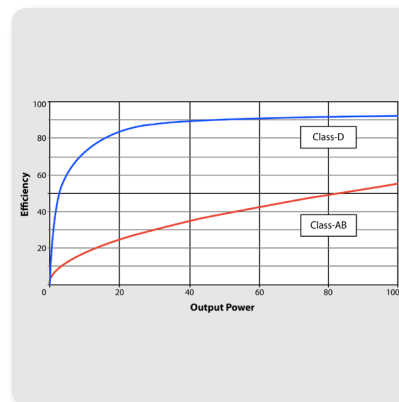

## Class-D – Massive Power, Perfect Sound

Equipped with a very efficient and lightweight LAB GRUPPEN IDEEA Class-D power amplifier, the VXP 8 provides an impressive 1,600 Watts of output power in a highly portable and lightweight package. Class-D amplification makes all the difference, offering the ultimate in energy efficiency and eliminating the need for heavy power supplies and large heat sinks.

## Install

# VXP 8

1,600 Watt 8" Dual Concentric Powered Sound Reinforcement Loudspeaker with Integrated LAB GRUPPEN IDEEA Class-D Amplification

## Dual Concentric Driver

The 1,600-Watt 200 mm (8") version of TANNÖY's VXP Series powered point source loudspeakers, VXP 8's constant directivity Dual Concentric drive unit technology ensures high power output with high sensitivity and exceptional efficiency. VXP 8 delivers precise 90° dispersion for optimum coverage with exceptional forward gain.



## Performance Applications

VXP 8's trapezoidal enclosure design provides a multitude of placement options including: small scale FOH, floor monitor, delay and stage front fill deployment, and more. A blanking plate for optional VTH pole mounting is provided for placement atop a subwoofer in small-scale portable PA applications. An extensive range of optional high performance steel mounting hardware (available separately) includes a horizontal yoke bracket, and Omnimount\* spaced inserts for wall and ceiling installation. All hardware has been tested and certified for a greater than 5:1 safety ratio – giving installers complete peace of mind.

## Construction

Finished in a hard wearing semi matt black paint, the vented and internally braced cabinet is constructed from 15 mm (5/8") plywood – and includes a rugged powder coated perforated steel mesh grille. The rear panel connector plate carries a switch for selecting between full range (FR) or high pass filter (HPF) operation, and fully balanced input and link output on Neutrik\* XLR connectors for input and link connections to additional powered enclosures. A secure locking Neutrik powerCON\* connector delivers mains power to the electronics, with a selection switch for either manual (MAN) or auto (AUTO) operation. VXP 8 loudspeakers are optimized for use LAKE LM Series controllers, and a full range of DSP settings to suit many configurations is available for free download at [tannoy.com](http://tannoy.com).



# VXP 8

1,600 Watt 8" Dual Concentric Powered Sound Reinforcement Loudspeaker with Integrated LAB GRUPPEN IDEEA Class-D Amplification



## You Are Covered

We always strive to provide the best possible Customer Experience. Our products are made in our own [MUSIC Tribe](#) factory using state-of-the-art automation, enhanced production workflows and quality assurance labs with the most sophisticated test equipment available in the world. As a result, we have one of the lowest product failure rates in the industry, and we confidently back it up with a generous [Warranty program](#).

# VXP 8

1,600 Watt 8" Dual Concentric Powered Sound Reinforcement Loudspeaker with Integrated LAB GRUPPEN IDEEA Class-D Amplification

## Frequency Response Sensitivity 1 W / 1 m

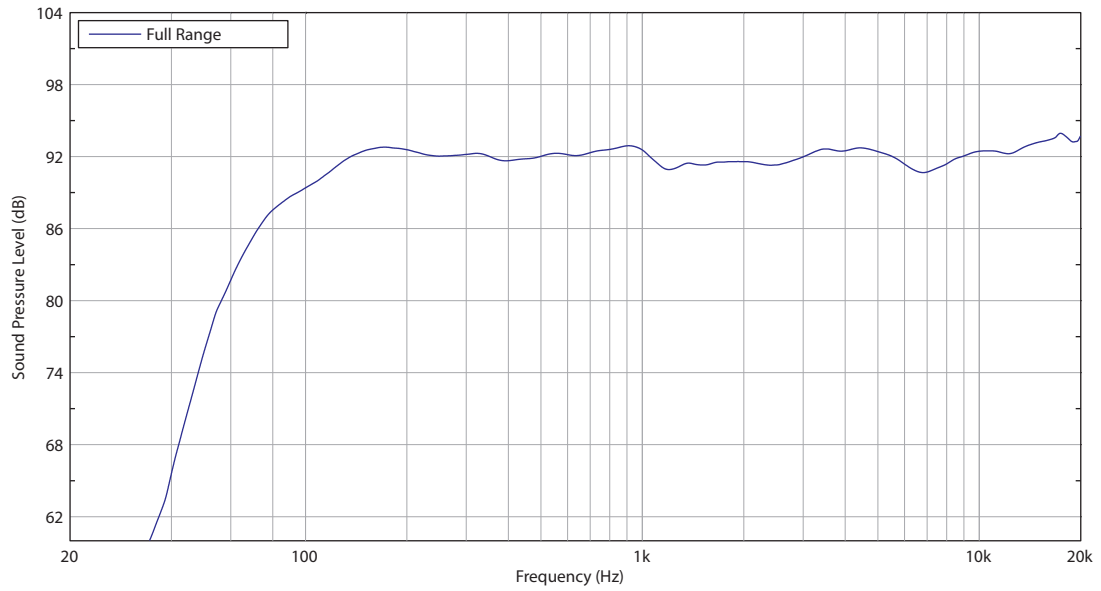

# VXP 8

1,600 Watt 8" Dual Concentric Powered Sound Reinforcement Loudspeaker with Integrated LAB GRUPPEN IDEEA Class-D Amplification

## Horizontal Beamwidth

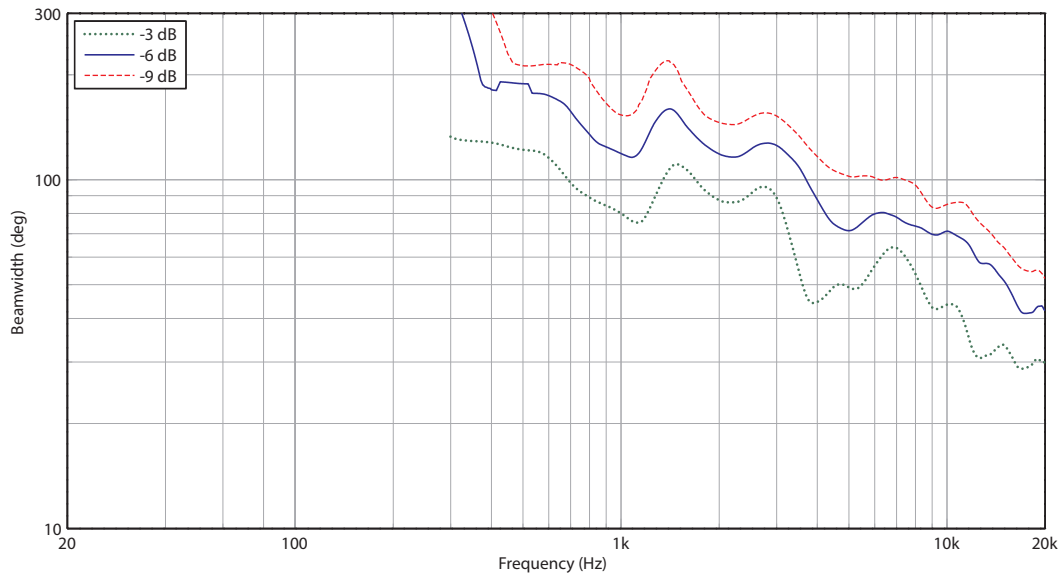

## Vertical Beamwidth

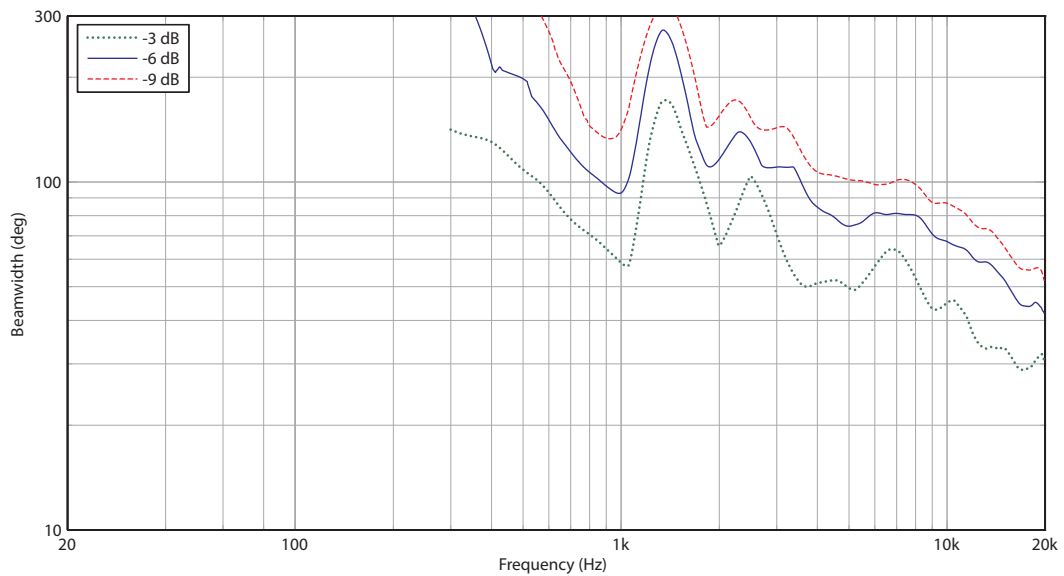

Install

# VXP 8

1,600 Watt 8" Dual Concentric Powered Sound Reinforcement Loudspeaker with Integrated LAB GRUPPEN IDEEA Class-D Amplification

## Horizontal Polar Plots

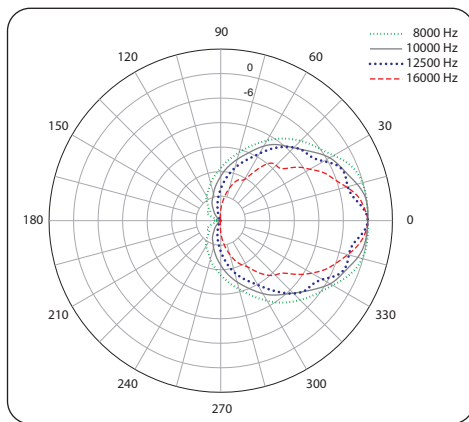
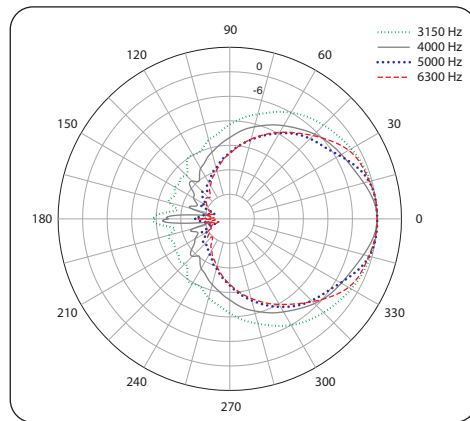
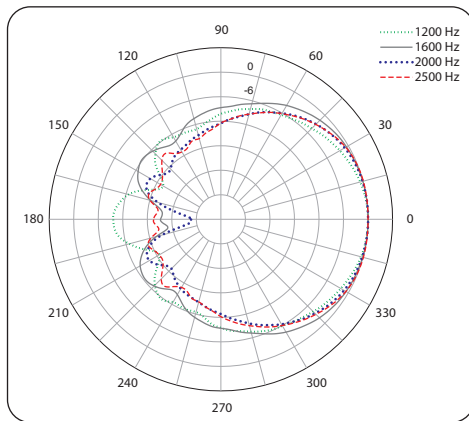
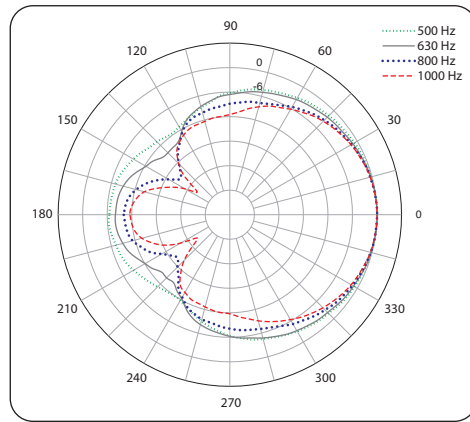
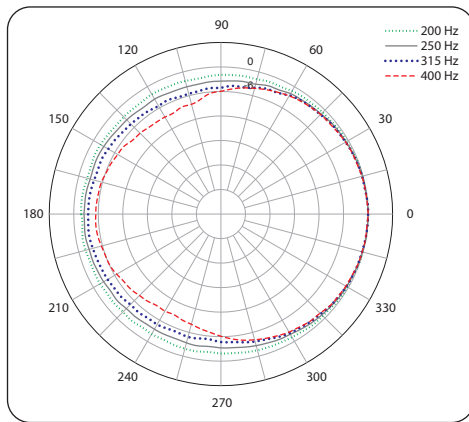

Install

# VXP 8

1,600 Watt 8" Dual Concentric Powered Sound Reinforcement Loudspeaker with Integrated LAB GRUPPEN IDEEA Class-D Amplification

## Vertical Polar Plots

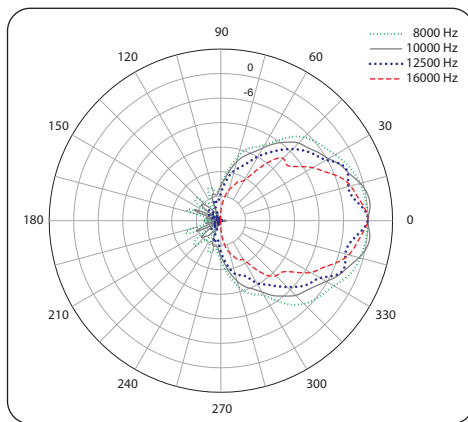
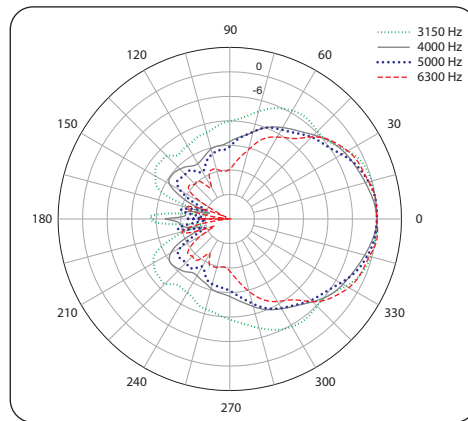
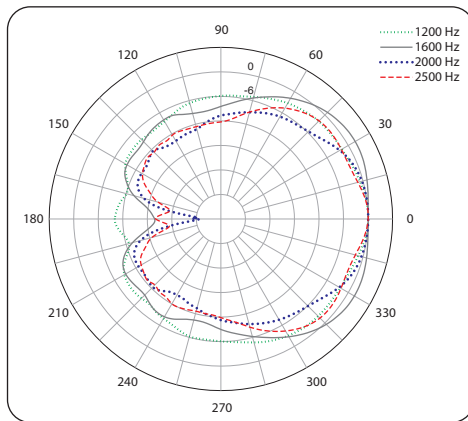
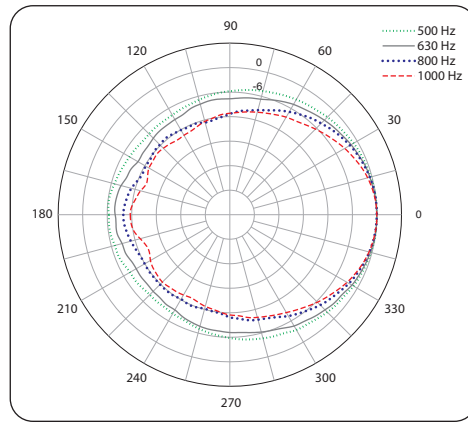
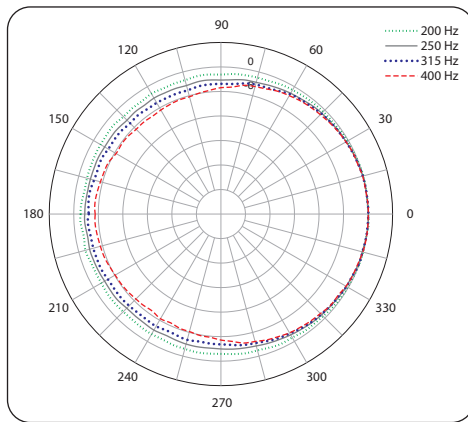

Install

# VXP 8

1,600 Watt 8" Dual Concentric Powered Sound Reinforcement Loudspeaker with Integrated LAB GRUPPEN IDEEA Class-D Amplification

## Dimensions

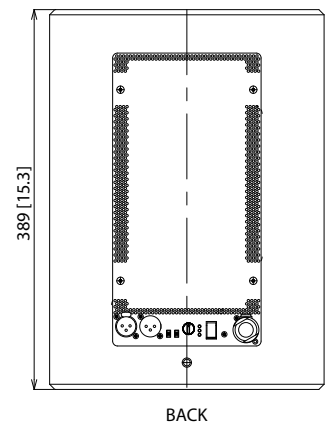
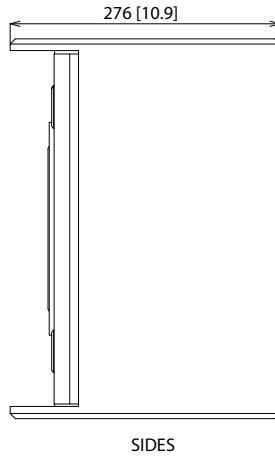
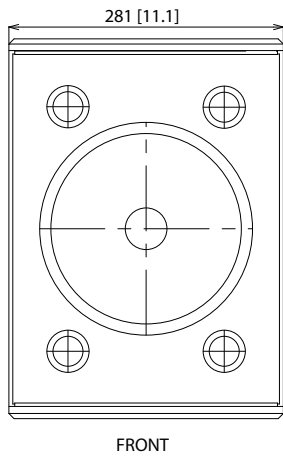
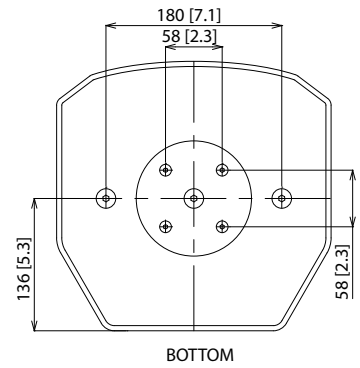
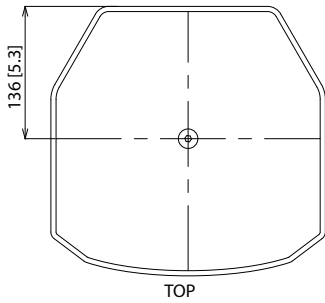



## Install

# VXP 8

1,600 Watt 8" Dual Concentric Powered Sound Reinforcement Loudspeaker with Integrated LAB GRUPPEN IDEEA Class-D Amplification

## Technical Specifications

### System

Frequency response (Full range mode)	80 Hz - 35 kHz $\pm$ 3 dB 67 Hz - 45 kHz -10 dB
Frequency response (Hi-pass mode)	120 Hz - 35 kHz $\pm$ 3 dB 100 Hz - 45 kHz -10 dB
Nominal dispersion	90° conical @ -6dB point
Directivity factor (Q)	6.8
Directivity index (DI)	7.9
Dynamic range	106 dB
Maximum SPL	125 dB peak
Crossover type	Passive 1.7 kHz with dynamic HF protection
Transducers	200 mm (1 x 8") constant directivity Dual Concentric™

### Amplifier

Maximum output power*	1600 W
Type	Class-D
Protection	Output current limiter, clip limiter, brownout protection and recovery, thermal

### Connectors

Input	1 x XLR, balanced
Input impedance	10 k $\Omega$ unbalanced, 20 k $\Omega$ balanced
Maximum input level for clip	+4.5 dBu (hard clip at +14.5 dBu input signal)
Link	1 x XLR
Mains Supply	Neutrik powerCON 20A†

### Controls

Level	Recessed potentiometer
Filter	Hi-pass (HPF)/ full range (FR), switchable
Power mode	Manual (MAN)/ auto (AUTO), switchable

### Power Supply

Type	Switch-mode autorange power supply
Mains voltage	100-240 V~, 50/60 Hz
Power consumption	75 W @ 1/8 max power

### Enclosure

Dimensions (HWD)	389 x 281 x 276 mm (15.3 x 11.1 x 10.9")
Net weight	10.1 kg (22.2 lbs)
Construction	15 mm (5/8") plywood, vented and internally braced
Finish	Semi matt black paint (white optional)
Grille	Powder coated perforated steel
Flying hardware	2 x M10 flying inserts 2 x M10 yoke bracket inserts (6 mm allen key) Blanking plate for optional VTH pole mount

### Accessories

Yoke Horizontal VX8  
Yoke Horizontal VX8 - WH  
Yoke Vertical VX8/VX8.2  
Yoke Vertical VX8/VX8.2 - WH  
VTH Top Hat

\*independent of limiters and driver protection circuits

†Neutrik and powerCON speakON are registered trademarks of Neutrik AG.

‡Only qualified personnel are allowed to modify the AC-Main cord and to adhere to all applicable national standards.

## Install

# VXP 8

1,600 Watt 8" Dual Concentric Powered Sound Reinforcement Loudspeaker with Integrated LAB GRUPPEN IDEEA Class-D Amplification

## Architecture & Engineering Specifications

The loudspeaker shall consist of a 200 mm (8") full-range, point source Dual Concentric transducer. The low and high frequency elements shall be driven by an integrated single-channel Class D amplifier through an internal passive crossover network operating at 1.7 kHz. The amplifier module shall incorporate an auto power down (APD) circuit that places the loudspeaker in standby mode with less than 1 W power consumption when input signal is absent for more than 20 minutes, resuming full operation when signal is again present at the input.

Performance of the loudspeaker shall meet or exceed the following criteria: Frequency response measured at 1 metre on axis with swept sine wave shall be 80 Hz to 35 kHz (3 dB) in full range mode and 120 Hz to 35 kHz in high pass mode. Rated peak SPL shall be 125 dB (anechoic) on axis at 1 metre. The dispersion of the loudspeaker shall be 90 degrees conical (-6 dB).

The enclosure shall be an optimally tuned 16.3 litre vented 15 mm (0.62") plywood cabinet. Connectors shall be 1 x female XLR (input), 1 x male XLR (link) and 1 x Neutrik powerCON. The speaker shall be fitted with the following controls and indicators: level control, blue power LED, green signal LED, red limit LED, full-range / high-pass switch (110 Hz) and a power switch. The enclosure shall be fitted with 4 x integral M10 inserts for flying hardware and 2 x M10 yoke bracket inserts. There shall be a blanking plate for an optional pole mount adaptor. The enclosure shall not exceed the following dimensions: 389 x 281 x 276 mm or 15.3 x 11.1 x 10.9" (H x W x D). The loudspeaker shall be the [TANNOY VXP 8](#).

## Install

# VXP 8

1,600 Watt 8" Dual Concentric Powered Sound Reinforcement Loudspeaker with Integrated LAB GRUPPEN IDEEA Class-D Amplification



## Install

# VXP 8

1,600 Watt 8" Dual Concentric Powered Sound Reinforcement Loudspeaker with Integrated LAB GRUPPEN IDEEA Class-D Amplification

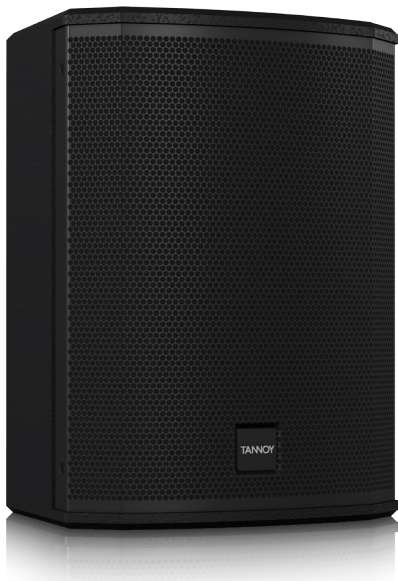
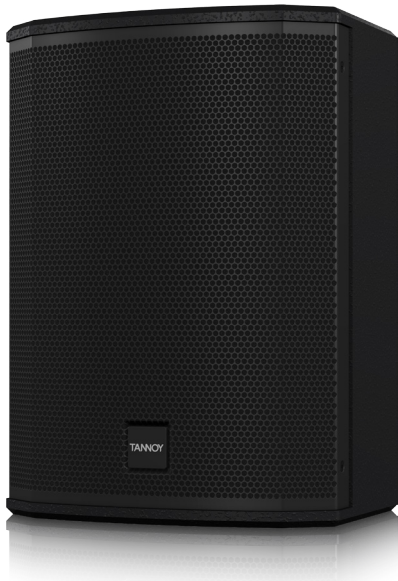

Install

# VXP 8

1,600 Watt 8" Dual Concentric Powered Sound  
Reinforcement Loudspeaker with Integrated  
LAB GRUPPEN IDEEA Class-D Amplification



Install

# VXP 8

1,600 Watt 8" Dual Concentric Powered Sound  
Reinforcement Loudspeaker with Integrated  
LAB GRUPPEN IDEEA Class-D Amplification



Install

# VXP 8

1,600 Watt 8" Dual Concentric Powered Sound Reinforcement Loudspeaker with Integrated LAB GRUPPEN IDEEA Class-D Amplification



For service, support or more information contact the TANNOY location nearest you:

**Europe**  
**MUSIC Tribe Brands UK Ltd.**  
 Tel: +44156 273 2290  
 Email: CARECrea@music-group.com  
 CAREEnte@music-group.com  
 CARELife@music-group.com

**USA/Canada**  
**MUSIC Tribe Commercial NV Inc.**  
 Tel: +1 702.800 8290  
 Email: CARECrea@music-group.com  
 CAREEnte@music-group.com  
 CARELife@music-group.com

**Japan**  
**MUSIC Tribe Services JP K.K.**  
 Tel: +81 3 6231 0453  
 Email: CARECrea@music-group.com  
 CAREEnte@music-group.com  
 CARELife@music-group.com

MUSIC Tribe accepts no liability for any loss which may be suffered by any person who relies either wholly or in part upon any description, photograph, or statement contained herein. Technical specifications, appearances and other information are subject to change without notice. All trademarks are the property of their respective owners. MIDAS, KLARK TEKNIK, LAB GRUPPEN, LAKE, TANNNOY, TURBOSOUND, TC ELECTRONIC, TC HELICON, BEHRINGER, BUGERA and COOLAUDIO are trademarks or registered trademarks of MUSIC Tribe Global Brands Ltd. © MUSIC Tribe Global Brands Ltd. 2018 All rights reserved.

