

Install

VXP 15HP-WH

1,600 Watt 15" PowerDual Powered Sound Reinforcement Loudspeaker with Integrated LAB GRUPPEN IDEEA Class-D Amplification (White)

- Full range multi-purpose powered sound reinforcement loudspeaker for portable and installation applications
- 1,600 Watt power featuring LAB GRUPPEN IDEEA electronics Class-D amplification
- 15" PowerDual full range driver for point source phase coherence
- Tightly controlled 75° dispersion for optimum coverage and forward projection
- Ideal for FOH, floor monitor and side fill applications
- Switchable full range or high pass filter operation
- Vented and internally braced plywood enclosure
- Finished with hard wearing semi matt white paint
- Rugged powder coated perforated steel mesh grille
- Blanking plate for optional VTH pole mount
- Versatile mounting via optional custom designed hardware
- Fully balanced input and link output on Neutrik* XLR connectors
- Neutrik powerCON* for a secure locking mains power connection
- 10-Year Warranty Program*
- Designed and engineered in the U.K.

The 1,600-Watt VXP 15HP-WH is built around a single 380 mm (15") PowerDual driver mounted within a compact, rugged plywood cabinet, and renowned for its exceptional performance and versatility. The latest high power-handling version of TANNOY's exclusive point source, VXP 15HP-WH's constant directivity PowerDual technology and LAB GRUPPEN IDEEA Class-D amplification ensure high power output with high sensitivity and exceptional efficiency. The point source driver technology allows this unique configuration to deliver exceptionally smooth beam-width characteristics resulting in an even coverage pattern aiding predictable system design. Symmetrical dispersion characteristics enhance speaker placement flexibility, allowing vertical or horizontal mounting of single or multi-cabinet arrays without any compromise in sound quality. The VXP 15HP-WH is also ideally suited for use complimenting much larger systems, making it an excellent choice for both installed and portable applications.

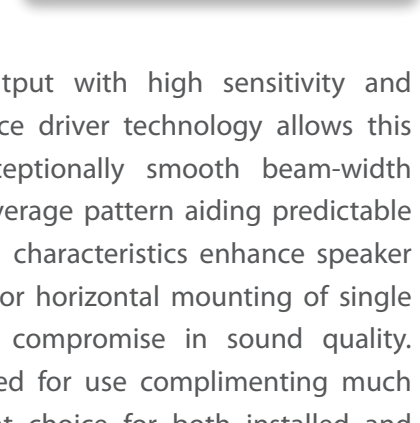

Install

VXP 15HP-WH

1,600 Watt 15" PowerDual Powered Sound Reinforcement Loudspeaker with Integrated LAB GRUPPEN IDEEA Class-D Amplification (White)

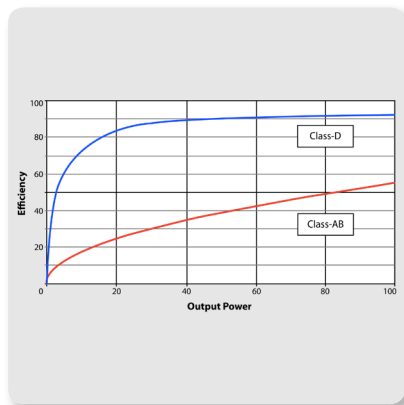

Class-D – Massive Power, Perfect Sound

Equipped with a very efficient and lightweight LAB GRUPPEN IDEEA Class-D power amplifier, the VXP 15HP-WH provides an impressive 1,600 Watts of output power in a highly portable and lightweight package. Class-D amplification makes all the difference, offering the ultimate in energy efficiency and eliminating the need for heavy power supplies and large heat sinks.

PowerDual Driver

The 1,600-Watt 380 mm (15") version of TANNOY's VXP Series exclusive point source loudspeakers, VXP 15HP-WH's PowerDual driver ensures high power output with high sensitivity and exceptional efficiency. VXP 15HP-WH delivers precise 75° dispersion for optimum coverage, exceptional forward gain plus the added benefit of improved low-mid extension from the twin driver configuration.



Performance Applications

VXP 15HP-WH's trapezoidal enclosure design provides a multitude of placement options including: FOH, floor monitor, delay, and more. A blanking plate for optional VTH pole mounting is provided for placement atop a subwoofer in small-scale portable PA applications. Mounting options include horizontal and vertical mounting yokes (available separately), an Omnimount* for wall and ceiling installation, and items to facilitate pole-mounting. All hardware has been tested and certified for a greater than 5:1 safety ratio – giving installers complete peace of mind.

Install

VXP 15HP-WH

1,600 Watt 15" PowerDual Powered Sound Reinforcement Loudspeaker with Integrated LAB GRUPPEN IDEEA Class-D Amplification (White)

Construction

Finished in a hard wearing semi matt white paint, the vented and internally braced cabinet is constructed from 18 mm (¾") plywood – and includes a rugged powder coated perforated steel mesh grille. The rear panel connector plate carries a switch for selecting between full range (FR) or high pass filter (HPF) operation, and fully balanced input and link output on Neutrik* XLR connectors for input and link connections to additional powered enclosures. A secure locking Neutrik powerCON* connector delivers mains power to the electronics, with a selection switch for either manual (MAN) or auto (AUTO) operation. VXP 15HP-WH loudspeakers are optimized for use LAKE LM Series controllers, and a full range of DSP settings to suit many configurations is available for free download at tannoy.com.



You Are Covered

We always strive to provide the best possible Customer Experience. Our products are made in our own MUSIC Tribe factory using state-of-the-art automation, enhanced production workflows and quality assurance labs with the most sophisticated test equipment available in the world. As a result, we have one of the lowest product failure rates in the industry, and we confidently back it up with a generous Warranty program.

Install

VXP 15HP-WH

1,600 Watt 15" PowerDual Powered Sound Reinforcement Loudspeaker with Integrated LAB GRUPPEN IDEEA Class-D Amplification (White)

Frequency Response Sensitivity 1 W / 1 m

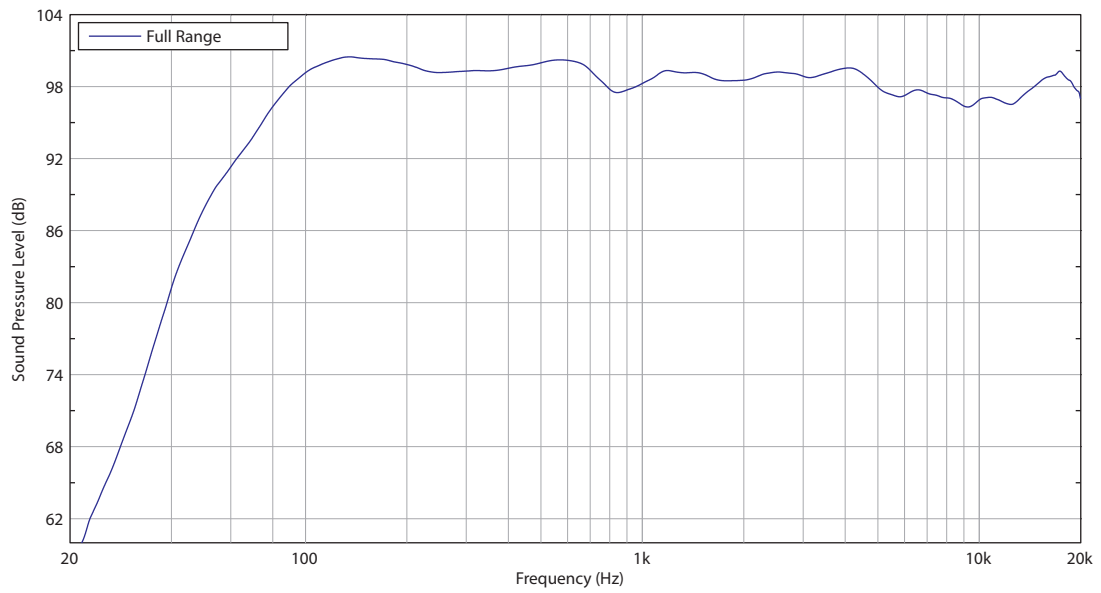

VXP 15HP-WH

1,600 Watt 15" PowerDual Powered Sound Reinforcement Loudspeaker with Integrated LAB GRUPPEN IDEEA Class-D Amplification (White)

Horizontal Beamwidth

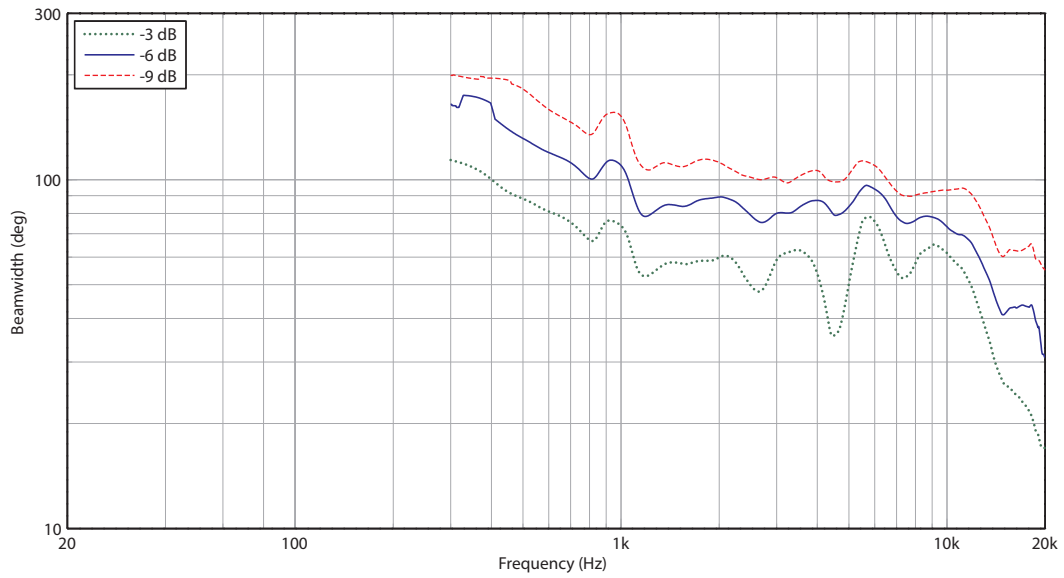

Vertical Beamwidth

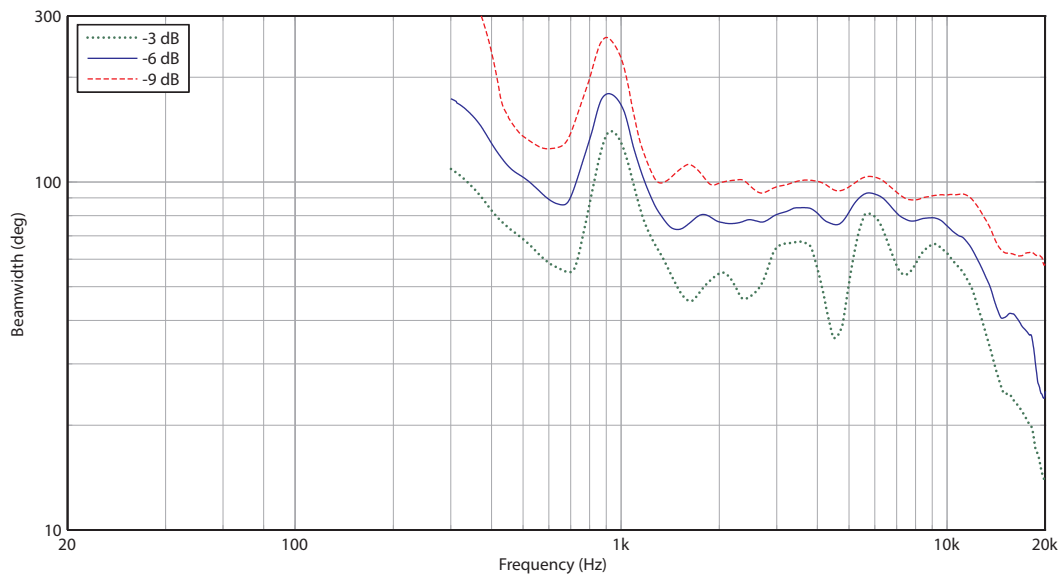

Install

VXP 15HP-WH

1,600 Watt 15" PowerDual Powered Sound Reinforcement Loudspeaker with Integrated LAB GRUPPEN IDEEA Class-D Amplification (White)

Horizontal Polar Plots

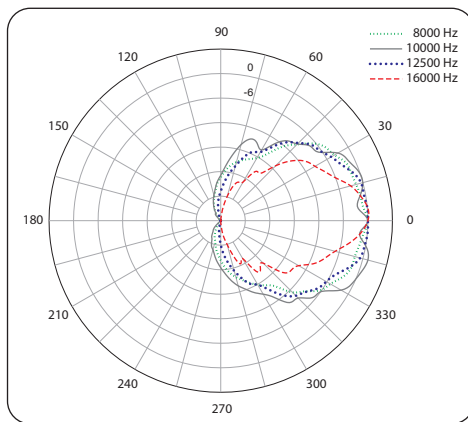
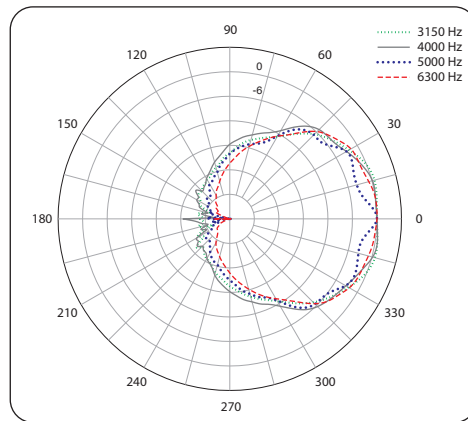
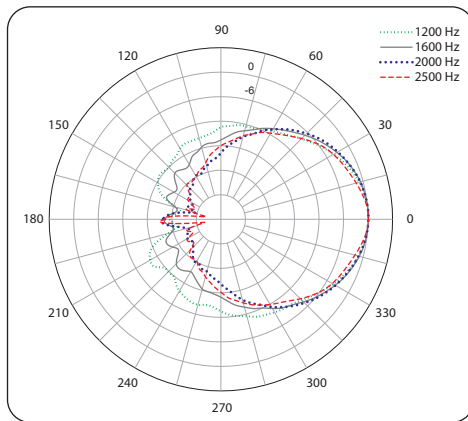
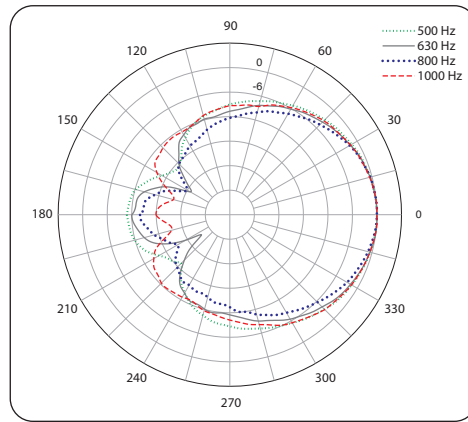
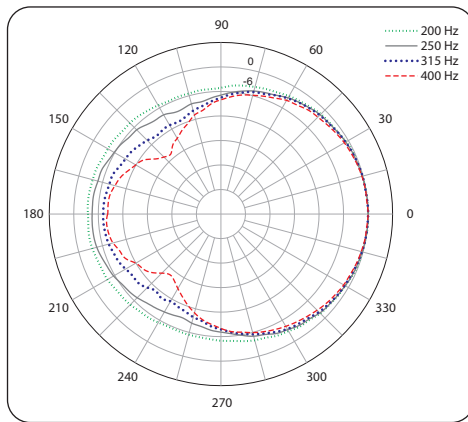

Install

VXP 15HP-WH

1,600 Watt 15" PowerDual Powered Sound Reinforcement Loudspeaker with Integrated LAB GRUPPEN IDEEA Class-D Amplification (White)

Vertical Polar Plots

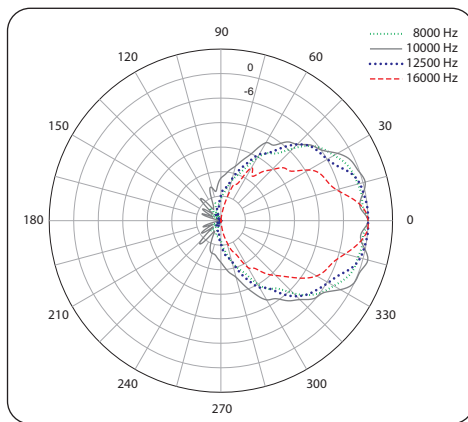
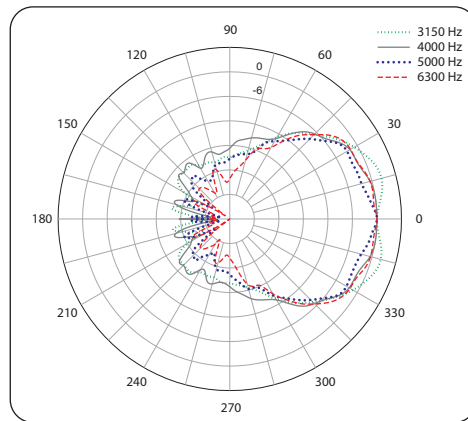
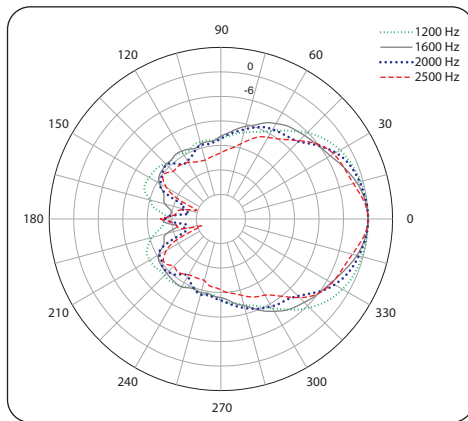
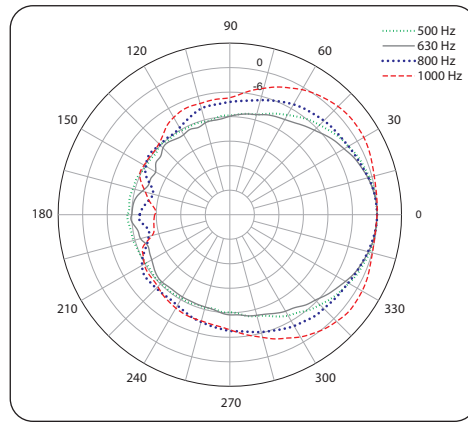
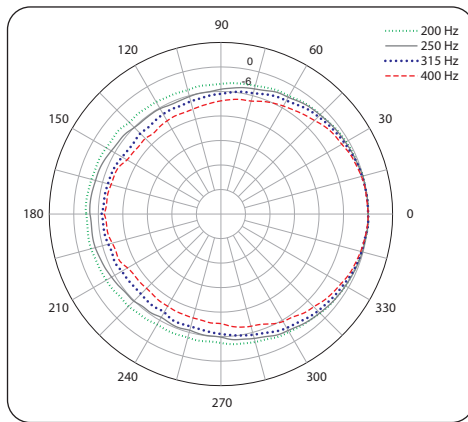

Install

VXP 15HP-WH

1,600 Watt 15" PowerDual Powered Sound Reinforcement Loudspeaker with Integrated LAB GRUPPEN IDEEA Class-D Amplification (White)

Dimensions

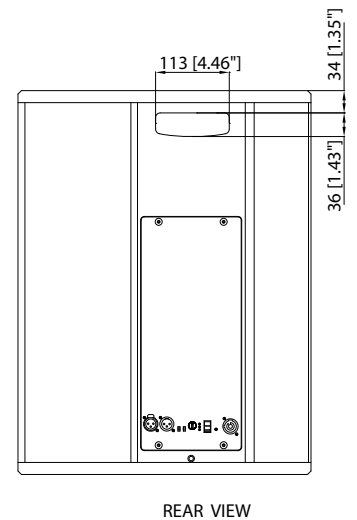
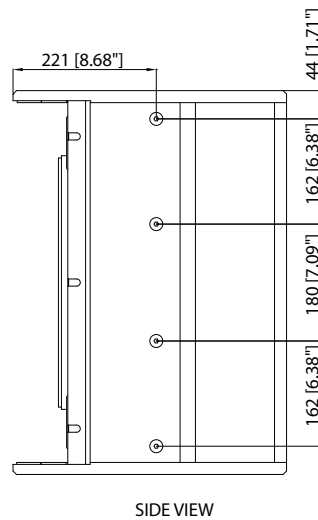
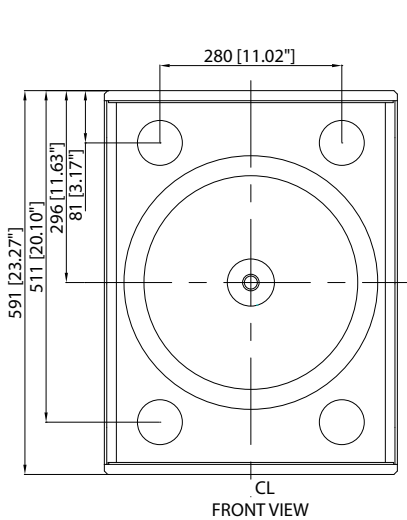
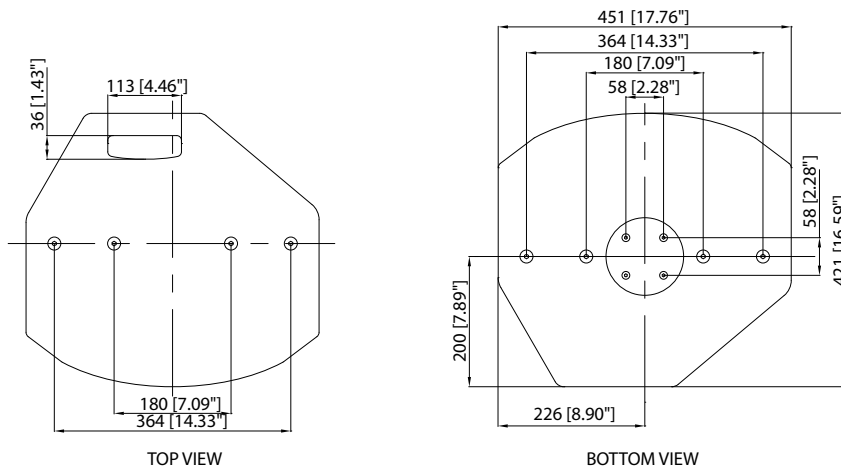

Install

VXP 15HP-WH

1,600 Watt 15" PowerDual Powered Sound Reinforcement Loudspeaker with Integrated LAB GRUPPEN IDEEA Class-D Amplification (White)

Technical Specifications

System

Frequency response (Full range mode)	60 Hz - 25 kHz \pm 3 dB 47 Hz - 30 kHz -10 dB
Frequency response (Hi-pass mode)	100 Hz - 25 kHz \pm 3 dB 80 Hz - 30 kHz -10 dB
Nominal dispersion	75° conical @ -6dB point
Directivity factor (Q)	9.7
Directivity index (DI)	9.9
Dynamic range	106 dB
Maximum SPL	131 dB peak
Crossover type	Passive 1.3 kHz
Transducers	380 mm (1 x 15") constant directivity PowerDual™

Amplifier

Maximum output power*	1600 W
Type	Class-D
Protection	Output current limiter, clip limiter, brownout protection and recovery, thermal

Connectors

Input	1 x XLR, balanced
Input impedance	10 k Ω unbalanced, 20 k Ω balanced
Maximum input level for clip	+4.5 dBu (hard clip at +14.5 dBu input signal)
Link	1 x XLR
Mains Supply	Neutrik powerCON 20A†

Controls

Level	Recessed potentiometer
Filter	Hi-pass (HPF)/ full range (FR), switchable
Power mode	Manual (MAN)/ auto (AUTO), switchable

Power Supply

Type	Switch-mode autorange power supply
Mains voltage	100-240 V~, 50/60 Hz
Power consumption	150 W @ 1/8 max power

Enclosure

Dimensions (H x W x D)	591 x 451 x 421 mm (23.3 x 17.8 x 16.6")
Net weight	27.3 kg (60.1 lbs)
Construction	18 mm (¾") plywood, vented and internally braced
Finish	Semi matt black paint (white optional)
Grille	Powder coated perforated steel
Flying hardware	8 x M10 corner flying inserts 8 x M10 yoke bracket inserts 1 x Integrip carrying handles Blanking plate for optional VTH pole mount

Accessories

Yoke Horizontal VX15
Yoke Vertical VX15
VTH Top Hat

*independent of limiters and driver protection circuits

†Neutrik and powerCON speakON are registered trademarks of Neutrik AG.

‡Only qualified personnel are allowed to modify the AC-Main cord and to adhere to all applicable national standards.

TANNOY

Install

VXP 15HP-WH

1,600 Watt 15" PowerDual Powered Sound
Reinforcement Loudspeaker with Integrated
LAB GRUPPEN IDEEA Class-D
Amplification (White)

Architecture & Engineering Specifications

The loudspeaker shall consist of a 380 mm (15") full-range, point source Power Dual transducer. The low and high frequency elements shall be driven by an integrated single-channel Class D amplifier through an internal passive crossover network operating at 1.3 kHz. The amplifier module shall incorporate an auto power down (APD) circuit that places the loudspeaker in standby mode with less than 1 W power consumption when input signal is absent for more than 20 minutes, resuming full operation when signal is again present at the input.

Performance of the loudspeaker shall meet or exceed the following criteria: Frequency response measured at 1 metre on axis with swept sine wave shall be 60 Hz to 25 kHz (3 dB) in full-range mode and 100 Hz to 25 kHz in high-pass mode. Rated peak SPL shall be 131 dB (anechoic) on axis at 1 metre. The dispersion of the loudspeaker shall be 75 degrees conical (-6 dB).

The enclosure shall be an optimally tuned 54.9 litre vented 18 mm (0.71") plywood cabinet. Connectors shall be 1 x female XLR (input), 1 x male XLR (link) and 1 x Neutrik powerCON. The speaker shall be fitted with the following controls and indicators: level control, blue power LED, green signal LED, red limit LED, full range / high pass switch (110 Hz) and a power switch. The enclosure shall be fitted with 8 x integral M10 inserts for flying hardware, 8 x M10 yoke bracket inserts and an integrated carrying handle. There shall be a blanking plate for an optional pole mount adaptor. The enclosure shall not exceed the following dimensions: 591 x 451 x 421 mm or 23.3 x 17.8 x 16.6" (H x W x D). The loudspeaker shall be the [TANNOY VXP 15HP](#).

Install

VXP 15HP-WH

1,600 Watt 15" PowerDual Powered Sound
Reinforcement Loudspeaker with Integrated
LAB GRUPPEN IDEEA Class-D
Amplification (White)

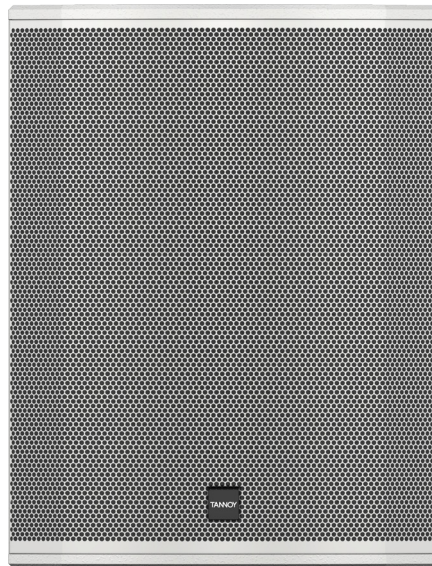

Install

VXP 15HP-WH

1,600 Watt 15" PowerDual Powered Sound
Reinforcement Loudspeaker with Integrated
LAB GRUPPEN IDEEA Class-D
Amplification (White)

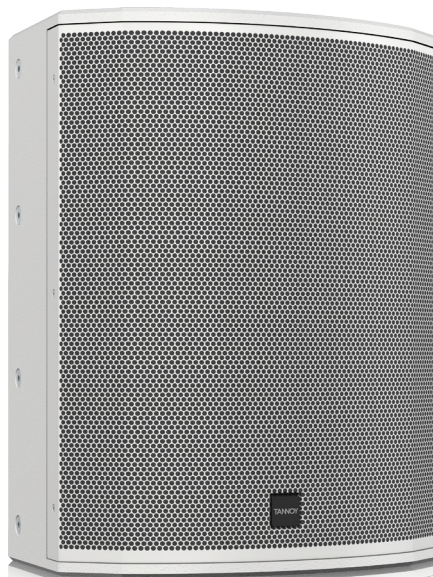
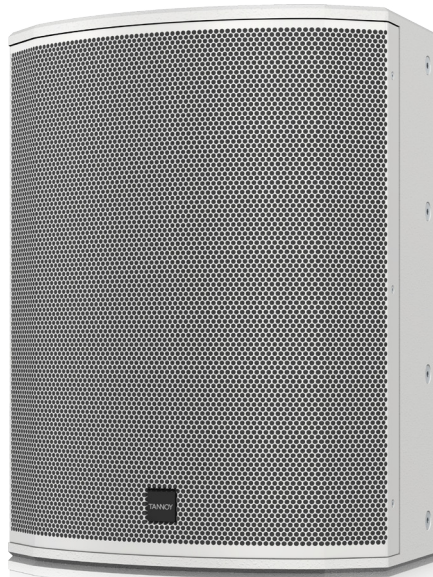

Install

VXP 15HP-WH

1,600 Watt 15" PowerDual Powered Sound
Reinforcement Loudspeaker with Integrated
LAB GRUPPEN IDEEA Class-D
Amplification (White)

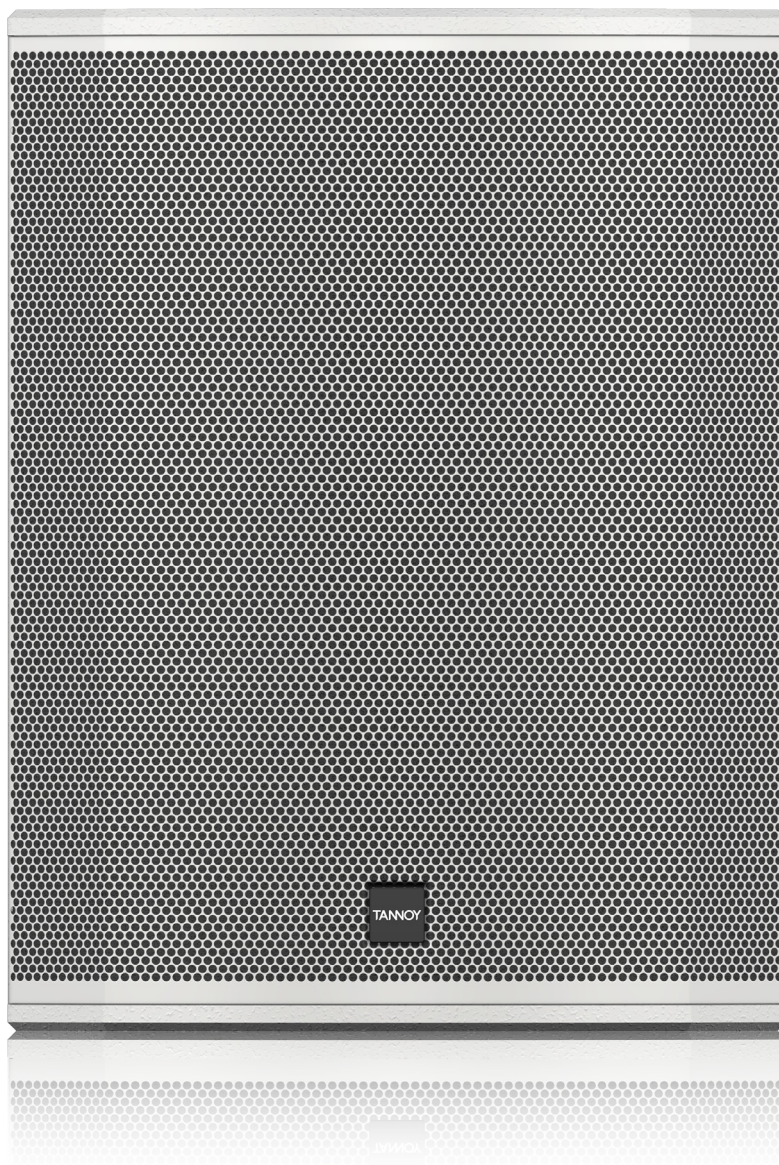

Install

VXP 15HP-WH

1,600 Watt 15" PowerDual Powered Sound
Reinforcement Loudspeaker with Integrated
LAB GRUPPEN IDEEA Class-D
Amplification (White)



Install

VXP 15HP-WH

1,600 Watt 15" PowerDual Powered Sound Reinforcement Loudspeaker with Integrated LAB GRUPPEN IDEEA Class-D Amplification (White)



For service, support or more information contact the TANNOY location nearest you:

Europe
MUSIC Tribe Brands UK Ltd.
 Tel: +44156 273 2290
 Email: CARECrea@music-group.com
 CAREEnte@music-group.com
 CARELife@music-group.com

USA/Canada
MUSIC Tribe Commercial NV Inc.
 Tel: +1 702.800 8290
 Email: CARECrea@music-group.com
 CAREEnte@music-group.com
 CARELife@music-group.com

Japan
MUSIC Tribe Services JP K.K.
 Tel: +81 3 6231 0453
 Email: CARECrea@music-group.com
 CAREEnte@music-group.com
 CARELife@music-group.com

MUSIC Tribe accepts no liability for any loss which may be suffered by any person who relies either wholly or in part upon any description, photograph, or statement contained herein. Technical specifications, appearances and other information are subject to change without notice. All trademarks are the property of their respective owners. MIDAS, KLARK TEKNIK, LAB GRUPPEN, LAKE, TANNNOY, TURBOSOUND, TC ELECTRONIC, TC HELICON, BEHRINGER, BUGERA and COOLAUDIO are trademarks or registered trademarks of MUSIC Tribe Global Brands Ltd. © MUSIC Tribe Global Brands Ltd. 2018 All rights reserved.

