

Install Speakers

DVS 6T (EN 54)

6" Coaxial Surface-Mount Loudspeaker with Transformer for Installation Applications (EN 54 Certified)

- Full range surface-mount loudspeaker for indoor and outdoor installation applications
- 60 Watts continuous, 240 Watts peak power
- 6" mineral loaded polypropylene driver with nitrile rubber surround for enhanced durability and long-term reliability
- 0.75" ferrofluid cooled soft dome neodymium high frequency driver
- 90° constant directivity dispersion for optimum coverage
- EN 54-24 certified for fire detection and fire alarm systems
- UV and weather resistant UL 94 V-0 ABS enclosure
- Multiple transformer taps for 70 V and 100 V line systems
- Low insertion loss 60 W line transformer with EN 54 compliant tamper-resistant tapping switch
- All components weather resistant to IP64 for outdoor use
- Stylish durable enclosure in a semi matt black paint finish fits unobtrusively in any environment
- Painted perforated aluminium mesh grille with dust protection
- Yoke bracket included for ease of installation
- Phoenix* connectors with ABS cover and EN 54 compliant strain relief clamping mechanism for fire rated cable
- 5-Year Warranty Program*
- Designed and engineered in the U.K.



Designed to excel in a wide variety of sound reinforcement applications, the full range DVS 6T (EN 54) is an ultra-compact 240-Watt surface mount loudspeaker that provides both exceptional value and inspiring acoustic performance. The DVS 6T (EN 54) is ideally suited for stereo or mono background/foreground music applications in theme parks, hotels, restaurants and bars, retail stores, as well as corporate AV, residential developments, and houses of worship. EN 54-24 certification for fire detection and fire alarm systems makes the DVS 6T (EN 54) the perfect choice where safety is a top priority.



Superb Point-Source Performance

DVS 6T (EN 54)'s point-source design comprises a 150 mm (6.00") mid bass driver with a coaxially mounted 19 mm (0.75") high frequency section mounted in a stylish injection moulded ABS enclosure. Certified for water and dust ingress protection to IP64 standard, the DVS 6T (EN 54) is an exceptional choice for challenging environments such as indoor swimming pools, saunas, or work areas with unusually high levels of dust or moisture, and outdoor applications where weather conditions are moderate.

Install Speakers

DVS 6T (EN 54)

6" Coaxial Surface-Mount Loudspeaker with Transformer for Installation Applications (EN 54 Certified)

Attractive and Easy to Install

The highly durable and scuff resistant ABS enclosure features a semi mat black painted finish, and comes with an aesthetically pleasing aluminium grille. Installation is quick and easy, thanks to the included colour-matched steel mounting bracket and finger-adjustable hardware on the enclosure top and bottom. Additionally, two threaded inserts are provided on the back of the cabinet, which are compatible with industry standard brackets. Phoenix* I/O connectors with ABS cover and EN 54 compliant strain relief clamping mechanism for fire rated cable are provided for added convenience.



You Are Covered

We always strive to provide the best possible Customer Experience. Our products are made in our own MUSIC Group factory using state-of-the-art automation, enhanced production workflows and quality assurance labs with the most sophisticated test equipment available in the world. As a result, we have one of the lowest product failure rates in the industry, and we confidently back it up with a generous [5-Year Warranty program](#).

Install Speakers

DVS 6T (EN 54)

6" Coaxial Surface-Mount Loudspeaker with Transformer for Installation Applications
(EN 54 Certified)

Frequency Response Sensitivity 1 W / 1 m

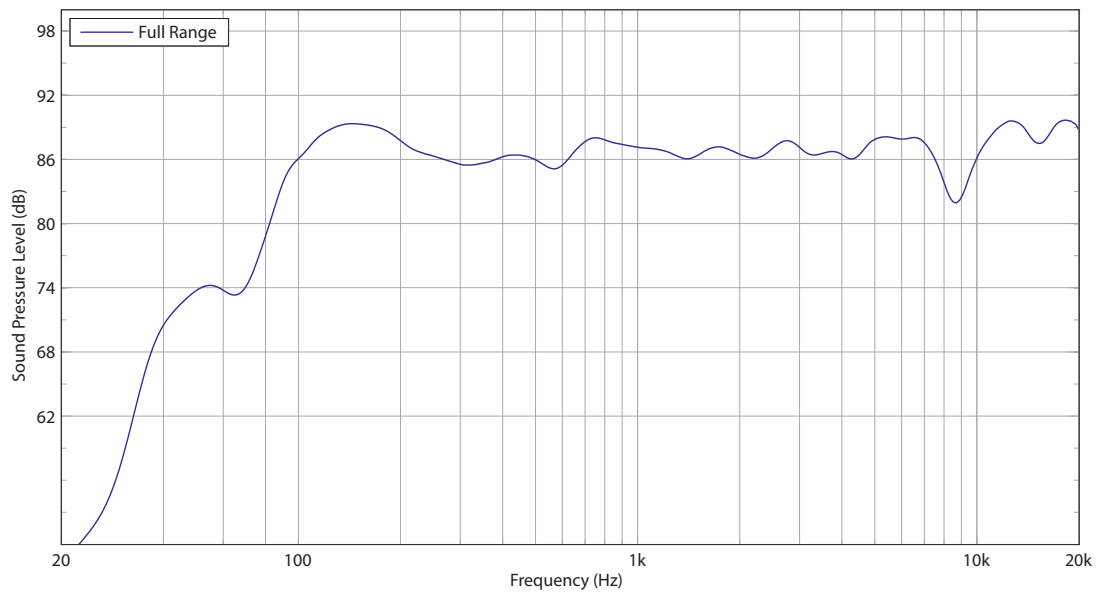

Impedance

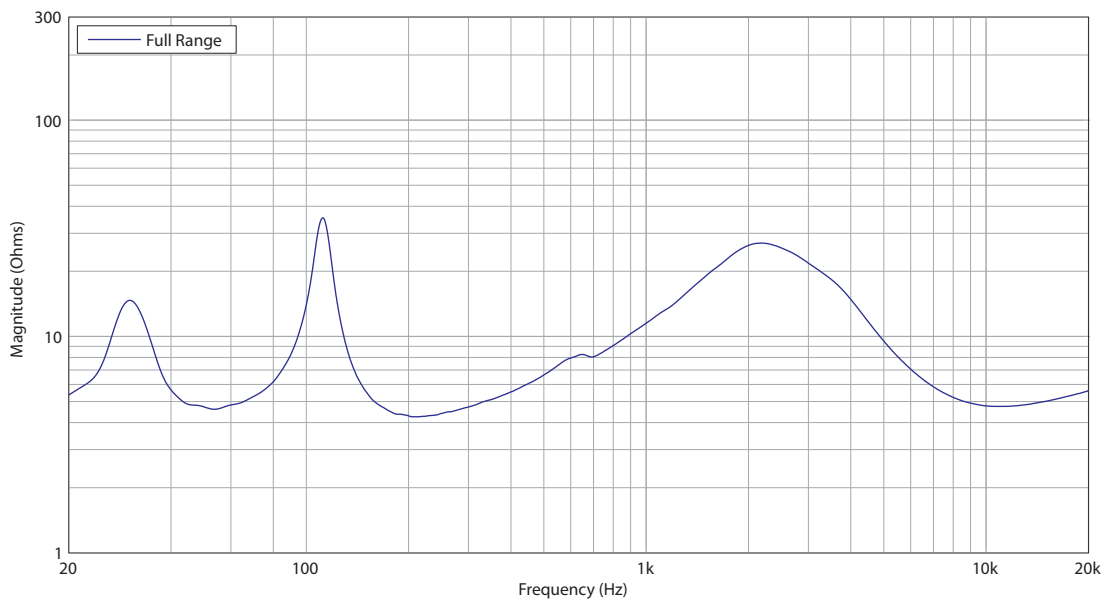

Install Speakers

DVS 6T (EN 54)

6" Coaxial Surface-Mount Loudspeaker with Transformer for Installation Applications
(EN 54 Certified)

Horizontal Beamwidth

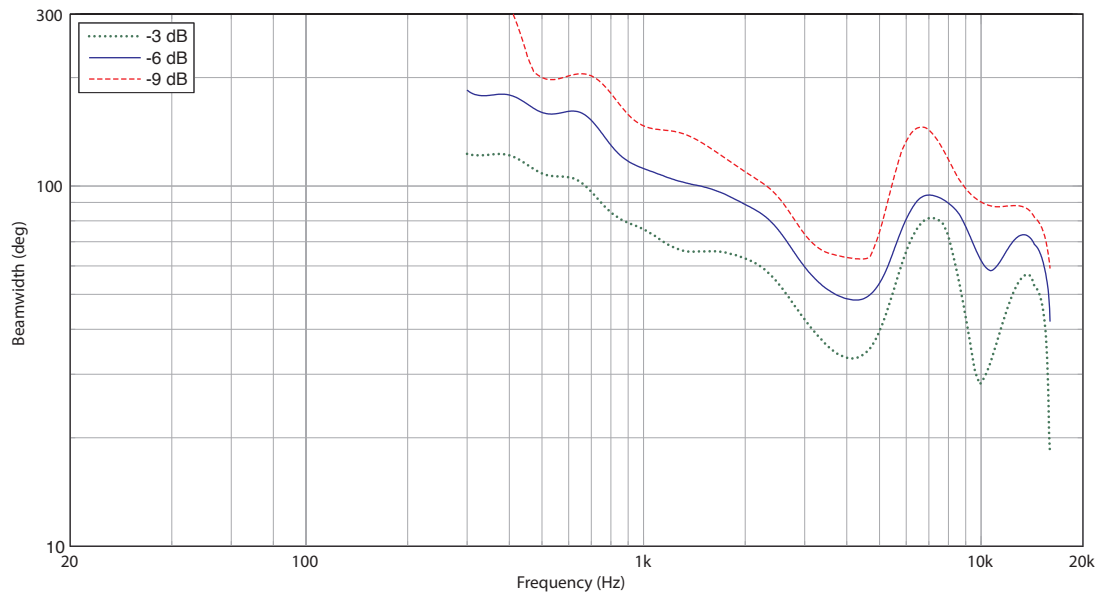

Vertical Beamwidth

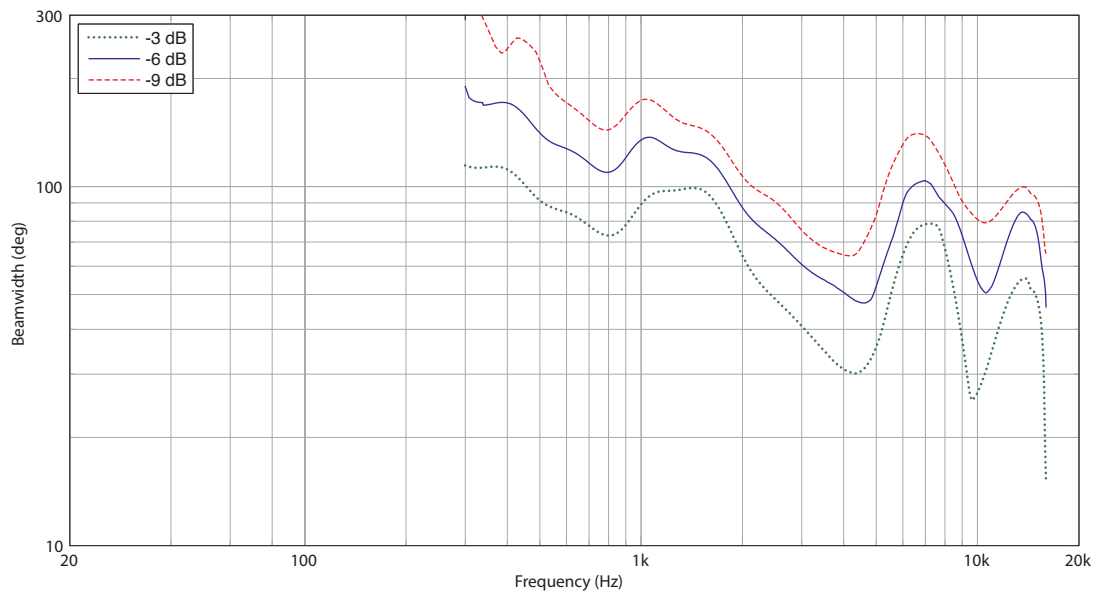

Install Speakers

DVS 6T (EN 54)

6" Coaxial Surface-Mount Loudspeaker with Transformer for Installation Applications
(EN 54 Certified)

Horizontal Polar Plots

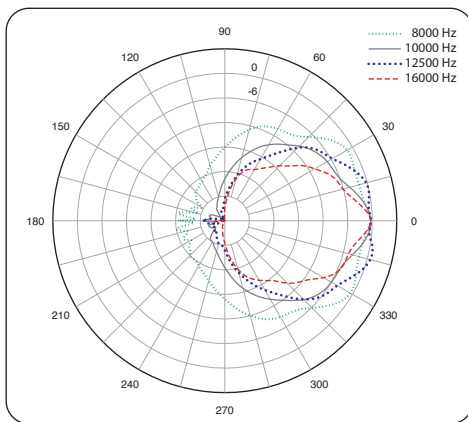
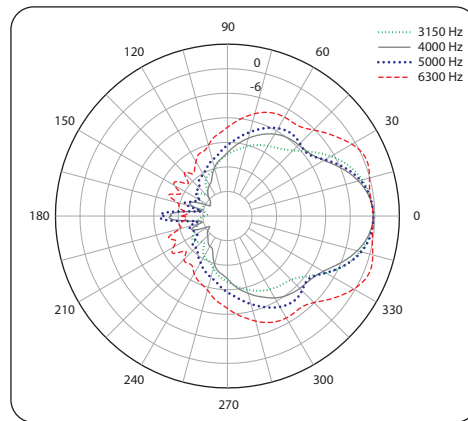
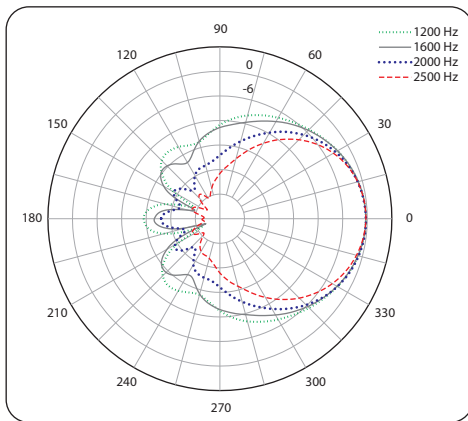
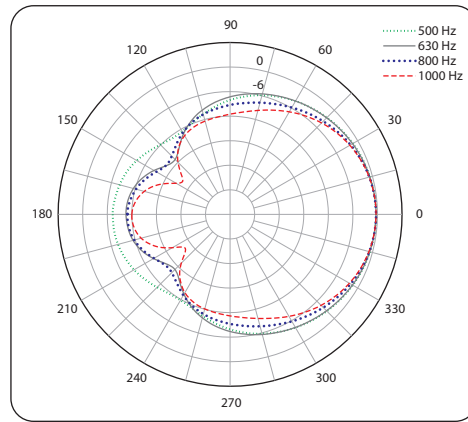
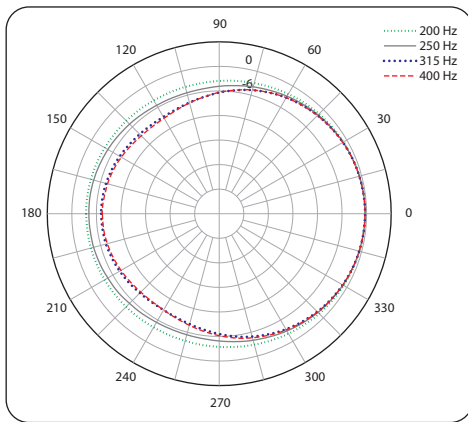

Install Speakers

DVS 6T (EN 54)

6" Coaxial Surface-Mount Loudspeaker with Transformer for Installation Applications
(EN 54 Certified)

Vertical Polar Plots

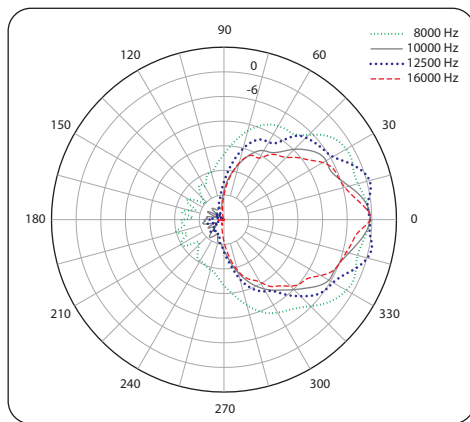
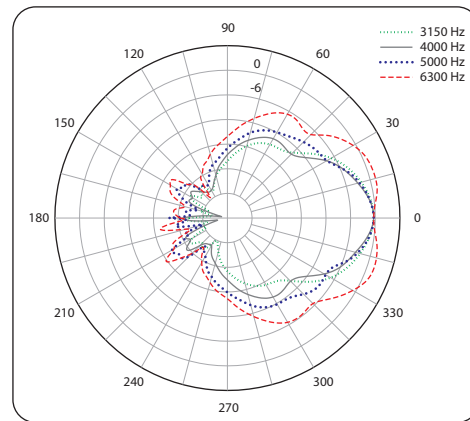
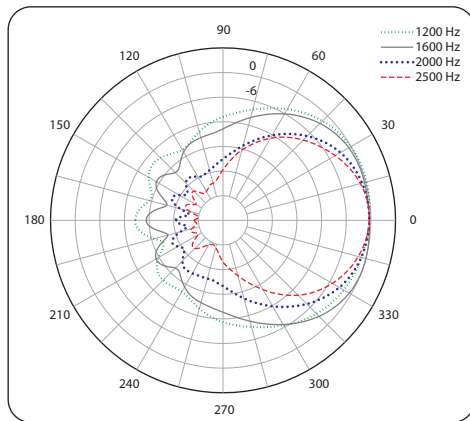
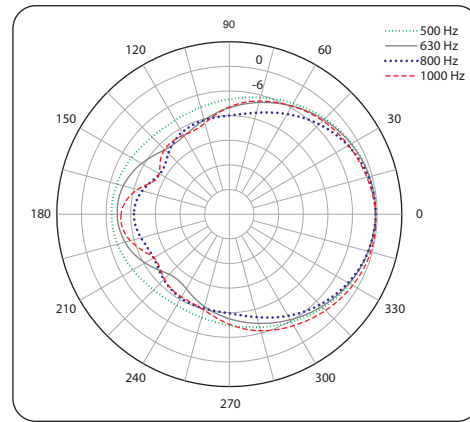
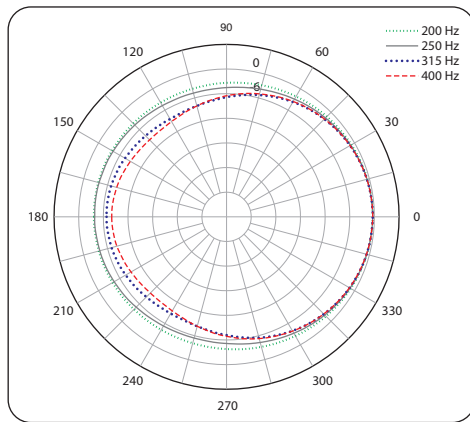

Install Speakers

DVS 6T (EN 54)

6" Coaxial Surface-Mount Loudspeaker with Transformer for Installation Applications
(EN 54 Certified)

Dimensions

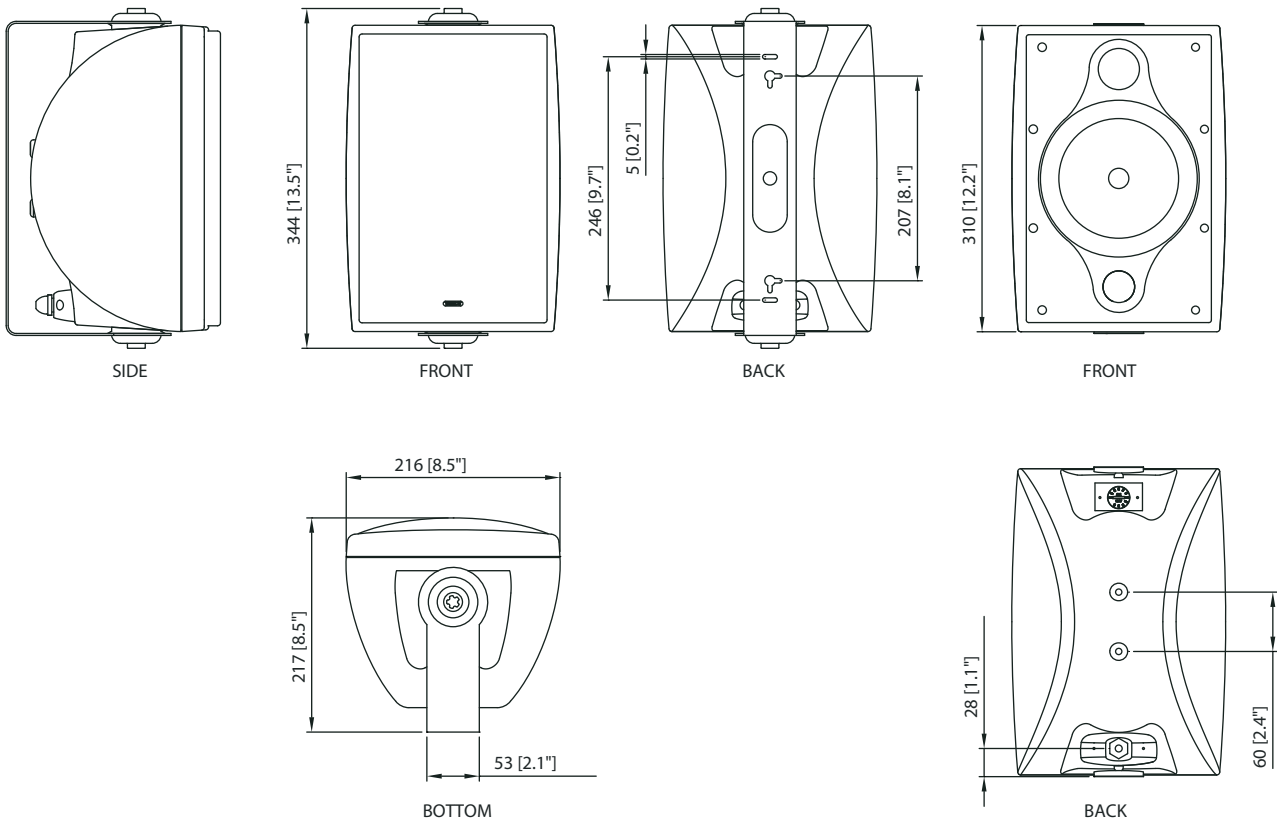

Install Speakers

DVS 6T (EN 54)

6" Coaxial Surface-Mount Loudspeaker with Transformer for Installation Applications (EN 54 Certified)

Technical Specifications

Performance

Frequency response (-3 dB)	80 Hz – 20 kHz
Frequency response (-10 dB)	65 Hz – 30 kHz
Rated sensitivity (1 W, Lo Z)	88 dB
Sensitivity as per EN54 (4 m, through transformer)	75.7 dB
Directivity factor (Q)	10.6 averaged 1 kHz to 10 kHz
Directivity index (DI)	9.6 averaged 1 kHz to 10 kHz
Power Handling	
Average	60 W
Programme	120 W
Peak	240 W
Recommended amplifier power	120 W @ 6 Ω
Nominal Impedance (Lo Z)	6 Ω
Maximum SPL as per EN54 (4 m, through transducer)	92 dB
Rated Maximum SPL (1 m, Lo Z)	
Average	105 dB
Peak	111 dB
Transformer Taps (Via Front Rotary Switch)	
70 V	60 W (70 Ω) / 30 W (165 Ω) / 15 W (280 Ω) / 7.5 W (580 Ω) / OFF & low impedance operation
100 V	60 W (165 Ω) / 30 W (280 Ω) / 15 W (580 Ω) / OFF & low impedance operation
Crossover point	4.3 kHz – 2nd order LF, 2nd order HF

Coverage Angles

500 Hz	360° horizontal, 288° vertical
1 kHz	167° horizontal, 141° vertical
2 kHz	99° horizontal, 109° vertical
4 kHz	74° horizontal, 74° vertical

Transducers

Low frequency	150 mm (6") mineral loaded cone material
High frequency	19 mm (0.75") coaxially mounted

Physical

Enclosure	ABS
Grille	Aluminium, painted
Transformer setting	Rotary switch
Connectors	Removable locking connector with screw terminals with "loop through" facility
Dimensions	341 x 212 x 217 mm (13.4 x 8.4 x 8.5")
Net weight	4.8 kg (10.6 lbs)
Shipped weight	5.7 kg (12.5 lbs)
Included accessories	Yoke bracket
Packed quantity	2

Notes:

- (1) Average over stated bandwidth. Measured in an IEC baffle in an Anechoic Chamber
- (2) Unweighted pink noise input, measured at 1 metre on axis
- (3) Long term power handling capacity as defined in EIA - 426B test
- (4) The reference point for the reference axis (on-axis) is the centre of the baffle. The horizontal and vertical planes are defined with the speaker mounted with the transformer tapping selector at the bottom

A full range of measurements, performance data, CLF and Ease Data for DVS 6T (EN54)/-WH and DVS 4T (EN54)/-WH can be downloaded from tannoy.com. They also apply to the DVS 6T (EN54)/-WH and DVS 4T (EN54)/-WH.

Install Speakers

DVS 6T (EN 54)

6" Coaxial Surface-Mount Loudspeaker with
Transformer for Installation Applications
(EN 54 Certified)

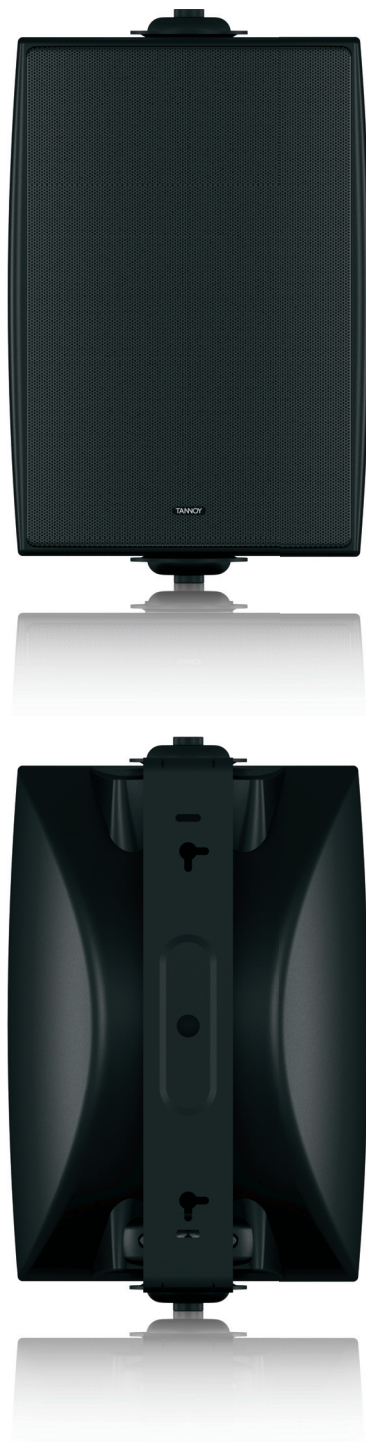

Install Speakers

DVS 6T (EN 54)

6" Coaxial Surface-Mount Loudspeaker with
Transformer for Installation Applications
(EN 54 Certified)



Install Speakers

DVS 6T (EN 54)

6" Coaxial Surface-Mount Loudspeaker with
Transformer for Installation Applications
(EN 54 Certified)



Install Speakers

DVS 6T (EN 54)

6" Coaxial Surface-Mount Loudspeaker with
Transformer for Installation Applications
(EN 54 Certified)



Install Speakers

DVS 6T (EN 54)

6" Coaxial Surface-Mount Loudspeaker with Transformer for Installation Applications (EN 54 Certified)

SUSPENDING THIS SYSTEM SHOULD ONLY BE DONE BY QUALIFIED PERSONS FOLLOWING SAFE INSTALLATION STANDARDS

EN54-24 TYPE B

CPR-DVSEN54-01

MADE IN CHINA

XXXX

DVS 6T (EN 54)

INPUT	POWER	WIRING	PASSIVE
70V LINE	7.5, 15, 30, 60 W	1+/2-	INPUT
100V LINE	15, 30, 60 W	3-/4+	LINK
6Ω	120 W PROGRAM	N/A	N/A

TANNOY

DESIGNED AND ENGINEERED IN ENGLAND

DESIGNED AND ENGINEERED IN ENGLAND



For service, support or more information contact the TANNOY location nearest you:

Europe
MUSIC Group Services UK
 Tel: +44 1562 547 100
 Email: CARE@music-group.com

USA/Canada
MUSIC Group Services NV Inc.
 Tel: +1 702 963 1300
 Email: CARE@music-group.com

Japan
MUSIC Group Services JP K.K.
 Tel: +81 3 5833 9121
 Email: CARE@music-group.com

MUSIC Group accepts no liability for any loss which may be suffered by any person who relies either wholly or in part upon any description, photograph, or statement contained herein. Technical specifications, appearances and other information are subject to change without notice. All trademarks are the property of their respective owners. MIDAS, KLARK TEKNIK, LAB GRUPPEN, LAKE, TANNOY, TURBOSOUND, TC ELECTRONIC, TC HELICON, BEHRINGER, BUGERA and DDA are trademarks or registered trademarks of MUSIC Group IP Ltd.
 © MUSIC Group IP Ltd. 2017 All rights reserved.

