



# ATHENS

## TCS Weather Resistant Series

TCS62-R (R-WH), TCS122/64-R (R-WH), TCS122/96-R (R-WH),  
TCS122/94-R (R-WH), TCS152/64-R (R-WH), TCS152/96-R (R-WH),  
TCS152/94-R (R-WH), TCS115B-R (R-WH), TCS218B-R (R-WH)

**Arrayable 2 Way Full Range Loudspeakers for Installation Applications  
(Weather Resistant)**

### Quickstart Guide





EN

**EN Important Safety Instructions**

 Terminals marked with this symbol carry electrical current of sufficient magnitude to constitute risk of electric shock. Use only high-quality commercially-available speaker cables with plugs pre-installed. All other installation or modification should be performed only by qualified personnel.

 This symbol, wherever it appears, alerts you to the presence of uninsulated dangerous voltage inside the enclosure - voltage that may be sufficient to constitute a risk of shock.

 This symbol, wherever it appears, alerts you to important operating and maintenance instructions in the accompanying literature. Please read the manual.

 **Caution**  
To reduce the risk of electric shock, do not remove the top cover (or the rear section). No user serviceable parts inside. Refer servicing to qualified personnel.

 **Caution**  
To reduce the risk of fire or electric shock, do not expose this appliance to rain and moisture. The apparatus shall not be exposed to dripping or splashing liquids and no objects filled with liquids, such as vases, shall be placed on the apparatus.

 **Caution**  
These service instructions are for use by qualified service personnel only. To reduce the risk of electric shock do not perform any servicing other than that contained in the operation instructions. Repairs have to be performed by qualified service personnel.

1. Read these instructions.
2. Keep these instructions.
3. Heed all warnings.
4. Follow all instructions.
5. Do not use this apparatus near water.
6. Clean only with dry cloth.
7. Do not block any ventilation openings. Install in accordance with the manufacturer's instructions.
8. Do not install near any heat sources such as radiators, heat registers, stoves, or other apparatus (including amplifiers) that produce heat.

9. Do not defeat the safety purpose of the polarized or grounding-type plug. A polarized plug has two blades with one wider than the other. A grounding-type plug has two blades and a third grounding prong. The wide blade or the third prong are provided for your safety. If the provided plug does not fit into your outlet, consult an electrician for replacement of the obsolete outlet.

10. Protect the power cord from being walked on or pinched particularly at plugs, convenience receptacles, and the point where they exit from the apparatus.

11. Use only attachments/accessories specified by the manufacturer.



12. Use only with the cart, stand, tripod, bracket, or table specified by the manufacturer, or sold with the apparatus. When a cart is used, use caution when

moving the cart/apparatus combination to avoid injury from tip-over.

13. Unplug this apparatus during lightning storms or when unused for long periods of time.

14. Refer all servicing to qualified service personnel. Servicing is required when the apparatus has been damaged in any way, such as power supply cord or plug is damaged, liquid has been spilled or objects have fallen into the apparatus, the apparatus has been exposed to rain or moisture, does not operate normally, or has been dropped.

15. The apparatus shall be connected to a MAINS socket outlet with a protective earthing connection.

16. Where the MAINS plug or an appliance coupler is used as the disconnect device, the disconnect device shall remain readily operable.



17. Correct disposal of this product: This symbol indicates that this product must not be disposed of with household waste, according to the WEEE Directive (2012/19/EU) and your national law.

This product should be taken to a collection center licensed for the recycling of waste electrical and electronic equipment (EEE). The mishandling of this type of waste could have a possible negative impact on the environment and human health due to potentially hazardous substances that are generally associated with EEE. At the same time, your cooperation in the correct disposal of this product will contribute to the efficient use of natural resources. For more information about where you can take your waste equipment for recycling, please contact your local city office, or your household waste collection service.

**LEGAL DISCLAIMER**

MUSIC Group accepts no liability for any loss which may be suffered by any person who relies either wholly or in part upon any description, photograph, or statement contained herein. Technical specifications, appearances and other information are subject to change without notice. All trademarks are the property of their respective owners. MIDAS, KLARK TEKNIK, TURBOSOUND, BEHRINGER, BUGERA and DDA are trademarks or registered trademarks of MUSIC Group IP Ltd. © MUSIC Group IP Ltd. 2014 All rights reserved.

**LIMITED WARRANTY**

For the applicable warranty terms and conditions and additional information regarding MUSIC Group's Limited Warranty, please see complete details online at [music-group.com/warranty](http://music-group.com/warranty).

ES

**ES Instrucciones de seguridad**

 Las terminales marcadas con este símbolo transportan corriente eléctrica de magnitud suficiente como para constituir un riesgo de descarga eléctrica. Utilice solo cables de altavoz de alta calidad con clavijas TS de 6,3 mm pre-instaladas (puede adquirirlas en comercios especializados en audio). Cualquier otra instalación o modificación debe ser realizada únicamente por un técnico cualificado.

 Este símbolo, siempre que aparece, le advierte de la presencia de voltaje peligroso sin aislar dentro de la caja; este voltaje puede ser suficiente para constituir un riesgo de descarga.

 Este símbolo, siempre que aparece, le advierte sobre instrucciones operativas y de mantenimiento que aparecen en la documentación adjunta. Por favor, lea el manual.

 **Atención**  
Para reducir el riesgo de descarga eléctrica, no quite la tapa (o la parte posterior). No hay piezas en el interior del equipo que puedan ser reparadas por el usuario. Si es necesario, póngase en contacto con personal cualificado.

 **Atención**  
Para reducir el riesgo de incendio o descarga eléctrica, no exponga este aparato a la lluvia, humedad o alguna otra fuente que pueda salpicar o derramar algún líquido sobre el aparato. No coloque ningún tipo de recipiente para líquidos sobre el aparato.

 **Atención**  
Las instrucciones de servicio deben llevarlas a cabo exclusivamente personal cualificado. Para evitar el riesgo de una descarga eléctrica, no realice reparaciones que no se encuentren descritas en el manual de operaciones. Las reparaciones deben ser realizadas exclusivamente por personal cualificado.

1. Lea las instrucciones.
2. Conserve estas instrucciones.
3. Preste atención a todas las advertencias.

4. Siga todas las instrucciones.
5. No use este aparato cerca del agua.
6. Limpie este aparato con un paño seco.
7. No bloquee las aberturas de ventilación. Instale el equipo de acuerdo con las instrucciones del fabricante.
8. No instale este equipo cerca de fuentes de calor tales como radiadores, acumuladores de calor, estufas u otros aparatos (incluyendo amplificadores) que puedan producir calor.
9. No elimine o deshabilite nunca la conexión a tierra del aparato o del cable de alimentación de corriente. Un enchufe polarizado tiene dos polos, uno de los cuales tiene un contacto más ancho que el otro. Una clavija con puesta a tierra dispone de tres contactos: dos polos y la puesta a tierra. El contacto ancho y el tercer contacto, respectivamente, son los que garantizan una mayor seguridad. Si el enchufe suministrado con el equipo no concuerda con la toma de corriente, consulte con un electricista para cambiar la toma de corriente obsoleta.
10. Coloque el cable de suministro de energía de manera que no pueda ser pisado y que esté protegido de objetos afilados. Asegúrese de que el cable de suministro de energía esté protegido, especialmente en la zona de la clavija y en el punto donde sale del aparato.
11. Use únicamente los dispositivos o accesorios especificados por el fabricante.



equipo, tenga cuidado para evitar daños y caídas al tropezar con algún obstáculo.

13. Desenchufe el equipo durante tormentas o si no va a utilizarlo durante un periodo largo.

14. Confíe las reparaciones únicamente a servicios técnicos cualificados. La unidad requiere mantenimiento siempre que haya sufrido algún daño, si el cable de suministro de energía o el enchufe presentaran daños, se hubiera derramado un líquido o hubieran caído objetos dentro del equipo, si el aparato hubiera estado expuesto a la humedad o la lluvia, si ha dejado de funcionar de manera normal o si ha sufrido algún golpe o caída.

15. Al conectar la unidad a la toma de corriente eléctrica asegúrese de que la conexión disponga de una unión a tierra.

16. Si el enchufe o conector de red sirve como único medio de desconexión, éste debe ser accesible fácilmente.



17. Cómo debe deshacerse de este aparato: Este símbolo indica que este aparato no debe ser tratado como basura orgánica, según lo indicado en la Directiva WEEE (2012/19/EU) y a las

normativas aplicables en su país. En lugar de ello deberá llevarlo al punto limpio más cercano para el reciclaje de sus elementos eléctricos / electrónicos (EEE). Al hacer esto estará ayudando a prevenir las posibles consecuencias negativas para el medio ambiente y la salud que podrían ser provocadas por una gestión inadecuada de este tipo de aparatos. Además, el reciclaje de materiales ayudará a conservar los recursos naturales. Para más información acerca del reciclaje de este aparato, póngase en contacto con el Ayuntamiento de su ciudad o con el punto limpio local.

**NEGACIÓN LEGAL**

MUSIC Group no admite ningún tipo de responsabilidad por cualquier daño o pérdida que pudiera sufrir cualquier persona por confiar total o parcialmente en la descripción, fotografías o afirmaciones contenidas en este documento. Las especificaciones técnicas, imágenes y otras informaciones contenidas en este documento están sujetas a modificaciones sin previo aviso. Todas las marcas comerciales que aparecen aquí son propiedad de sus respectivos dueños. MIDAS, KLARK TEKNIK, TURBOSOUND, BEHRINGER, BUGERA y DDA son marcas comerciales o marcas registradas de MUSIC Group IP Ltd. © MUSIC Group IP Ltd. 2014 Reservados todos los derechos.

**GARANTÍA LIMITADA**

Si quiere conocer los detalles y condiciones aplicables de la garantía así como información adicional sobre la Garantía limitada de MUSIC group, consulte online toda la información en la web [music-group.com/warranty](http://music-group.com/warranty).

EN

ES

**FR** Consignes de sécurité

Les points repérés par ce symbole portent une tension électrique suffisante pour constituer un risque d'électrocution. Utilisez uniquement des câbles d'enceintes de haute qualité disponibles dans les points de vente avec les connecteurs Jack mono 6,35 mm déjà installés. Toute autre installation ou modification doit être effectuée uniquement par un personnel qualifié.



Ce symbole avertit de la présence d'une tension dangereuse et non isolée à l'intérieur de l'appareil - elle peut provoquer des chocs électriques.



**Attention**  
Ce symbol signale les consignes d'utilisation et d'entre ! Tien importantes dans la documentation fournie. Lisez les consignes de sécurité du manuel d'utilisation de l'appareil.



**Attention**  
Pour éviter tout risque de choc électrique, ne pas ouvrir le capot de l'appareil ni démonter le panneau arrière. L'intérieur de l'appareil ne possède aucun élément réparable par l'utilisateur. Laisser toute réparation à un professionnel qualifié.



**Attention**  
Pour réduire les risques de feu et de choc électrique, n'exposez pas cet appareil à la pluie, à la moisissure, aux gouttes ou aux éclaboussures. Ne posez pas de récipient contenant un liquide sur l'appareil (un vase par exemple).



**Attention**  
Ces consignes de sécurité et d'entretien sont destinées à un personnel qualifié. Pour éviter tout risque de choc électrique, n'effectuez aucune réparation sur l'appareil qui ne soit décrite par le manuel d'utilisation. Les éventuelles réparations doivent être effectuées uniquement par un technicien spécialisé.

1. Lisez ces consignes.
2. Conservez ces consignes.
3. Respectez tous les avertissements.
4. Respectez toutes les consignes d'utilisation.
5. N'utilisez jamais l'appareil à proximité d'un liquide.

6. Nettoyez l'appareil avec un chiffon sec.

7. Veillez à ne pas empêcher la bonne ventilation de l'appareil via ses ouïes de ventilation. Respectez les consignes du fabricant concernant l'installation de l'appareil.

8. Ne placez pas l'appareil à proximité d'une source de chaleur telle qu'un chauffage, une cuisinière ou tout appareil dégageant de la chaleur (y compris un ampli de puissance).

9. Ne supprimez jamais la sécurité des prises bipolaires ou des prises terre. Les prises bipolaires possèdent deux contacts de largeur différente. Le plus large est le contact de sécurité. Les prises terre possèdent deux contacts plus une mise à la terre servant de sécurité. Si la prise du bloc d'alimentation ou du cordon d'alimentation fourni ne correspond pas à celles de votre installation électrique, faites appel à un électricien pour effectuer le changement de prise.

10. Installez le cordon d'alimentation de telle façon que personne ne puisse marcher dessus et qu'il soit protégé d'arêtes coupantes. Assurez-vous que le cordon d'alimentation est suffisamment protégé, notamment au niveau de sa prise électrique et de l'endroit où il est relié à l'appareil; cela est également valable pour une éventuelle rallonge électrique.

11. Utilisez exclusivement des accessoires et des appareils supplémentaires recommandés par le fabricant.



12. Utilisez exclusivement des chariots, des diables, des présentoirs, des pieds et des surfaces de travail recommandés par le fabricant

ou livrés avec le produit. Déplacez précautionneusement tout chariot ou diable chargé pour éviter d'éventuelles blessures en cas de chute.

13. Débranchez l'appareil de la tension secteur en cas d'orage ou si l'appareil reste inutilisé pendant une longue période de temps.

14. Les travaux d'entretien de l'appareil doivent être effectués uniquement par du personnel qualifié. Aucun entretien n'est nécessaire sauf si l'appareil est endommagé de quelque façon que ce soit (dommages sur le cordon d'alimentation ou la prise par exemple), si un liquide ou un objet a pénétré à l'intérieur du châssis, si l'appareil a été exposé à la pluie ou à l'humidité, s'il ne fonctionne pas correctement ou à la suite d'une chute.

15. L'appareil doit être connecté à une prise secteur dotée d'une protection par mise à la terre.

16. La prise électrique ou la prise IEC de tout appareil dénué de bouton marche/arrêt doit rester accessible en permanence.



17. Mise au rebut appropriée de ce produit: Ce symbole indique qu'en accord avec la directive DEEE (2012/19/EU) et les lois en vigueur dans votre pays, ce produit ne doit pas être jeté avec les

déchets ménagers. Ce produit doit être déposé dans un point de collecte agréé pour le recyclage des déchets d'équipements électriques et électroniques (EEE). Une mauvaise manipulation de ce type de déchets pourrait avoir un impact négatif sur l'environnement et la santé à cause des substances potentiellement dangereuses généralement associées à ces équipements. En même temps, votre coopération dans la mise au rebut de ce produit contribuera à l'utilisation efficace des ressources naturelles. Pour plus d'informations sur l'endroit où vous pouvez déposer vos déchets d'équipements pour le recyclage, veuillez contacter votre mairie ou votre centre local de collecte des déchets.

**DÉNI LÉGAL**

MUSIC Group ne peut être tenu pour responsable pour toute perte pouvant être subie par toute personne se fiant en partie ou en totalité à toute description, photographie ou affirmation contenue dans ce document. Les caractéristiques, l'apparence et d'autres informations peuvent faire l'objet de modifications sans notification. Toutes les marques appartiennent à leurs propriétaires respectifs. MIDAS, KLARK TEKNIK, TURBOSOUND, BEHRINGER, BUGERA et DDA sont des marques ou marques déposées de MUSIC Group IP Ltd. © MUSIC Group IP Ltd. 2014 Tous droits réservés.

**GARANTIE LIMITÉE**

Pour connaître les termes et conditions de garantie applicables, ainsi que les informations supplémentaires et détaillées sur la Garantie Limitée de MUSIC Group, consultez le site Internet [music-group.com/warranty](http://music-group.com/warranty).

**DE** Wichtige Sicherheitshinweise

**Vorsicht**  
Die mit dem Symbol markierten Anschlüsse führen so viel Spannung, dass die Gefahr eines Stromschlags besteht. Verwenden Sie nur hochwertige, im Handel erhältliche Lautsprecherkabel mit vorinstallierten 6,3 mm TS-Steckern. Alle anderen Installationen oder Modifikationen sollten nur von qualifiziertem Fachpersonal ausgeführt werden.



**Achtung**  
Um eine Gefährdung durch Stromschlag auszuschließen, darf die Geräteabdeckung bzw. Geräterückwand nicht abgenommen werden. Im Innern des Geräts befinden sich keine vom Benutzer reparierbaren Teile. Reparaturarbeiten dürfen nur von qualifiziertem Personal ausgeführt werden.



**Achtung**  
Um eine Gefährdung durch Feuer bzw. Stromschlag auszuschließen, darf dieses Gerät weder Regen oder Feuchtigkeit ausgesetzt werden noch sollten Spritzwasser oder tropfende Flüssigkeiten in das Gerät gelangen können. Stellen Sie keine mit Flüssigkeit gefüllten Gegenstände, wie z. B. Vasen, auf das Gerät.



**Achtung**  
Die Service-Hinweise sind nur durch qualifiziertes Personal zu befolgen. Um eine Gefährdung durch Stromschlag zu vermeiden, führen Sie bitte keinerlei Reparaturen an dem Gerät durch, die nicht in der Bedienungsanleitung detailliert sind. Reparaturen sind nur von qualifiziertem Fachpersonal durchzuführen.

1. Lesen Sie diese Hinweise.
2. Bewahren Sie diese Hinweise auf.
3. Beachten Sie alle Warnhinweise.
4. Befolgen Sie alle Bedienungshinweise.
5. Betreiben Sie das Gerät nicht in der Nähe von Wasser.
6. Reinigen Sie das Gerät mit einem trockenen Tuch.
7. Blockieren Sie nicht die Belüftungsschlitze. Beachten Sie beim Einbau des Gerätes die Herstellerhinweise.
8. Stellen Sie das Gerät nicht in der Nähe von Wärmequellen auf. Solche Wärmequellen sind z. B. Heizkörper, Herde oder andere Wärme erzeugende Geräte (auch Verstärker).

9. Entfernen Sie in keinem Fall die Sicherheitsvorrichtung von Zweipol- oder geerdeten Steckern. Ein Zweipolstecker hat zwei unterschiedlich breite Steckkontakte. Ein geerdeter Stecker hat zwei Steckkontakte und einen dritten Erdungskontakt. Der breitere Steckkontakt oder der zusätzliche Erdungskontakt dient Ihrer Sicherheit. Falls das mitgelieferte Steckerformat nicht zu Ihrer Steckdose passt, wenden Sie sich bitte an einen Elektriker, damit die Steckdose entsprechend ausgetauscht wird.

10. Verlegen Sie das Netzkabel so, dass es vor Tritten und scharfen Kanten geschützt ist und nicht beschädigt werden kann. Achten Sie bitte insbesondere im Bereich der Stecker, Verlängerungskabel und an der Stelle, an der das Netzkabel das Gerät verlässt, auf ausreichenden Schutz.

11. Das Gerät muss jederzeit mit intaktem Schutzleiter an das Stromnetz angeschlossen sein.

12. Sollte der Hauptnetzstecker oder eine Gerätesteckdose die Funktionseinheit zum Abschalten sein, muss diese immer zugänglich sein.

13. Verwenden Sie nur Zusatzgeräte/ Zubehörteile, die laut Hersteller geeignet sind.



14. Verwenden Sie nur Wagen, Standvorrichtungen, Stative, Halter oder Tische, die vom Hersteller benannt oder im Lieferumfang des Geräts enthalten

sind. Falls Sie einen Wagen benutzen, seien Sie vorsichtig beim Bewegen der Wagen-Gerätkombination, um Verletzungen durch Stolpern zu vermeiden.

15. Ziehen Sie den Netzstecker bei Gewitter oder wenn Sie das Gerät längere Zeit nicht benutzen.

16. Lassen Sie alle Wartungsarbeiten nur von qualifiziertem Service-Personal ausführen. Eine Wartung ist notwendig, wenn das Gerät in irgendeiner Weise beschädigt wurde (z. B. Beschädigung des Netzkabels oder Steckers), Gegenstände oder Flüssigkeit in das Geräteinnere gelangt sind, das Gerät Regen oder Feuchtigkeit ausgesetzt wurde, das Gerät nicht ordnungsgemäß funktioniert oder auf den Boden gefallen ist.



17. Korrekte Entsorgung dieses Produkts: Dieses Symbol weist darauf hin, das Produkt entsprechend der WEEE Richtlinie (2012/19/EU) und der jeweiligen nationalen Gesetze nicht zusammen mit Ihren Haushaltsabfällen zu entsorgen. Dieses Produkt sollte bei einer autorisierten Sammelstelle für Recycling elektrischer und elektronischer Geräte (EEE) abgegeben werden. Wegen bedenklicher Substanzen,

die generell mit elektrischen und elektronischen Geräten in Verbindung stehen, könnte eine unsachgemäße Behandlung dieser Abfallart eine negative Auswirkung auf Umwelt und Gesundheit haben. Gleichzeitig gewährleistet Ihr Beitrag zur richtigen Entsorgung dieses Produkts die effektive Nutzung natürlicher Ressourcen. Für weitere Informationen zur Entsorgung Ihrer Geräte bei einer Recycling-Stelle nehmen Sie bitte Kontakt zum zuständigen städtischen Büro, Entsorgungsamt oder zu Ihrem Haushaltsabfallentsorger auf.

**HAFTUNGSAUSSCHLUSS**

MUSIC Group übernimmt keine Haftung für Verluste, die Personen entstanden sind, die sich ganz oder teilweise auf hier enthaltene Beschreibungen, Fotos oder Aussagen verlassen haben. Technische Daten, Erscheinungsbild und andere Informationen können ohne vorherige Ankündigung geändert werden. Alle Warenzeichen sind Eigentum der jeweiligen Inhaber. MIDAS, KLARK TEKNIK, TURBOSOUND, BEHRINGER, BUGERA und DDA sind Warenzeichen oder eingetragene Warenzeichen der MUSIC Group IP Ltd. © MUSIC Group IP Ltd. 2014 Alle Rechte vorbehalten.

**BESCHRÄNKTE GARANTIE**

Die geltenden Garantiebedingungen und zusätzliche Informationen bezüglich der von MUSIC Group gewährten beschränkten Garantie finden Sie online unter [music-group.com/warranty](http://music-group.com/warranty).

## PT Instruções de Segurança Importantes



### Aviso!

Terminais marcados com o símbolo carregam corrente elétrica de magnitude suficiente para constituir um risco de choque elétrico. Use apenas cabos de alto-falantes comercialmente disponíveis de alta qualidade com plugues TS de ¼" pré-instalados. Todas as outras instalações e modificações devem ser efetuadas por pessoas qualificadas.



Este símbolo, onde quer que o encontre, alerta-o para a leitura das instruções de manuseamento que acompanham o equipamento. Por favor leia o manual de instruções.



### Atenção

De forma a diminuir o risco de choque elétrico, não remover a cobertura (ou a secção de trás). Não existem peças substituíveis por parte do utilizador no seu interior. Para esse efeito recorrer a um técnico qualificado.



### Atenção

Para reduzir o risco de incêndios ou choques elétricos o aparelho não deve ser exposto à chuva nem à humidade. Além disso, não deve ser sujeito a salpicos, nem devem ser colocados em cima do aparelho objectos contendo líquidos, tais como jarras.



### Atenção

Estas instruções de operação devem ser utilizadas, em exclusivo, por técnicos de assistência qualificados. Para evitar choques elétricos não proceda a reparações ou intervenções, que não as indicadas nas instruções de operação, salvo se possuir as qualificações necessárias. Para evitar choques elétricos não proceda a reparações ou intervenções, que não as indicadas nas instruções de operação. Só o deverá fazer se possuir as qualificações necessárias.

1. Leia estas instruções.
2. Guarde estas instruções.
3. Preste atenção a todos os avisos.
4. Siga todas as instruções.
5. Não utilize este dispositivo perto de água.
6. Limpe apenas com um pano seco.
7. Não obstrua as entradas de ventilação. Instale de acordo com as instruções do fabricante.

8. Não instale perto de quaisquer fontes de calor tais como radiadores, bocas de ar quente, fogões de sala ou outros aparelhos (incluindo amplificadores) que produzam calor.

9. Não anule o objectivo de segurança das fichas polarizadas ou do tipo de ligação à terra. Uma ficha polarizada dispõe de duas palhetas sendo uma mais larga do que a outra. Uma ficha do tipo ligação à terra dispõe de duas palhetas e um terceiro dente de ligação à terra. A palheta larga ou o terceiro dente são fornecidos para sua segurança. Se a ficha fornecida não encaixar na sua tomada, consulte um electricista para a substituição da tomada obsoleta.

10. Proteja o cabo de alimentação de pisadelas ou apertos, especialmente nas fichas, extensões, e no local de saída da unidade. Certifique-se de que o cabo eléctrico está protegido. Verifique particularmente nas fichas, nos receptáculos e no ponto em que o cabo sai do aparelho.

11. O aparelho tem de estar sempre conectado à rede eléctrica com o condutor de protecção intacto.

12. Se utilizar uma ficha de rede principal ou uma tomada de aparelhos para desligar a unidade de funcionamento, esta deve estar sempre acessível.

13. Utilize apenas ligações/acessórios especificados pelo fabricante.



14. Utilize apenas com o carrinho, estrutura, tripé, suporte, ou mesa especificados pelo fabricante ou vendidos com o dispositivo. Quando utilizar

um carrinho, tenha cuidado ao mover o conjunto carrinho/dispositivo para evitar danos provocados pela terpidação.

15. Desligue este dispositivo durante as trovoadas ou quando não for utilizado durante longos períodos de tempo.

16. Qualquer tipo de reparação deve ser sempre efectuado por pessoal qualificado. É necessária uma reparação sempre que a unidade tiver sido de alguma forma danificada, como por exemplo: no caso do cabo de alimentação ou ficha se encontrarem danificados; na eventualidade de líquido ter sido derramado ou objectos terem caído para dentro do dispositivo; no caso da unidade ter estado exposta à chuva ou à humidade; se esta não funcionar normalmente, ou se tiver caído.



17. Correcta eliminação deste produto: este símbolo indica que o produto não deve ser eliminado juntamente com os resíduos domésticos, segundo a Directiva REEE

(2012/19/EU) e a legislação nacional. Este produto deverá ser levado para um centro de recolha licenciado para a reciclagem de resíduos de equipamentos eléctricos e electrónicos (EEE). O tratamento incorrecto deste tipo de resíduos pode ter um eventual impacto negativo no ambiente e na saúde humana devido a substâncias potencialmente perigosas que estão geralmente associadas aos EEE. Ao mesmo tempo, a sua colaboração para a eliminação correcta deste produto irá contribuir para a utilização eficiente dos recursos naturais. Para mais informação acerca dos locais onde poderá deixar o seu equipamento usado para reciclagem, é favor contactar os serviços municipais locais, a entidade de gestão de resíduos ou os serviços de recolha de resíduos domésticos.

## LEGAL RENUNCIANTE

O MUSIC Group não se responsabiliza por perda alguma que possa ser sofrida por qualquer pessoa que dependa, seja de maneira completa ou parcial, de qualquer descrição, fotografia, ou declaração aqui contidas. Dados técnicos, aparências e outras informações estão sujeitas a modificações sem aviso prévio. Todas as marcas são propriedade de seus respectivos donos. MIDAS, KLARK TEKNIK, TURBOSOUND, BEHRINGER, BUGERA e DDA são marcas ou marcas registradas do MUSIC Group IP Ltd. © MUSIC Group IP Ltd. 2014 Todos direitos reservados.

## GARANTIA LIMITADA

Para obter os termos de garantia aplicáveis e condições e informações adicionais a respeito da garantia limitada do MUSIC group, favor verificar detalhes na íntegra através do website [music-group.com/warranty](http://music-group.com/warranty).

## JP 安全にお使いいただくために



### 注意

感電の恐れがありますので、カバーやその他の部品を取り外したり、開けたりしないでください。高品質なプロ用スピーカーケーブル (¼" TS 標準ケーブルおよびツイスト ロッキングプラグケーブル) を使用してください。



### 注意

火事および感電の危険を防ぐため、本装置を水分や湿気のあるところには設置しないで下さい。装置には決して水分がかからないように注意し、花瓶など水分を含んだものは、装置の上には置かないようにしてください。



### 注意

このマークが表示されている箇所には、内部に高圧電流が生じています。手を触れると感電の恐れがあります。



### 注意

取り扱いとお手入れの方法についての重要な説明が付属の取扱説明書に記載されています。ご使用前に良くお読みください。



### 注意

1. 取扱説明書を通してご覧ください。
2. 取扱説明書を大切に保管してください。
3. 警告に従ってください。
4. 指示に従ってください。
5. 本機を水の近くで使用しないでください。
6. お手入れの際は常に乾燥した布巾を使用してください。
7. 本機は、取扱説明書の指示に従い、適切な換気を妨げない場所に設置してください。取扱説明書に従って設置してください。
8. 本機は、電気ヒーターや温風機器、ストーブ、調理台やアンプといった熱源から離して設置してください。

9. 二極式プラグおよびアースタイプ (三芯) プラグの安全ピンは取り外さないでください。二極式プラグにはピンが二本ついており、そのうち一本はもう一方よりも幅が広がっています。アースタイプの三芯プラグには二本のピンに加えてアース用のピンが一本ついてます。これらの幅の広いピン、およびアースピンは、安全のためのものです。備え付けのプラグが、お使いのコンセントの形状と異なる場合は、電器技師に相談してコンセントの交換をして下さい。

10. 電源コードを踏みつけたり、挟んだりしないようご注意ください。電源コードやプラグ、コンセント及び製品との接続には十分にご注意ください。

11. すべての装置の接地 (アース) が確保されていることを確認して下さい。



12. 電源タップや電源プラグは電源遮断機として利用されている場合には、これが直ぐに操作できるように手元に設置して下さい。

13. 付属品は本機製造元が指定したもののみをお使いください。

14. カートスタンド、三脚、ブラケット、テーブルなどは、本機製造元が指定したものの、もしくは本機の付属品となるもののみをお使いください。カートを使用時の運搬の際は、器具の落下による怪我に十分ご注意ください。

15. 雷雨の場合、もしくは長期間ご使用にならない場合は、電源プラグをコンセントから抜いてください。

16. 故障の際は当社指定のサービス技術者にお問い合わせください。電源コードもしくはプラグの損傷、液体の装置内への浸入、装置の上に物が落下した場合、雨や湿気に装置が晒されてしまった場合、正常に作動しない場合、もしくは装置を地面に落下させてしまった場合など、いかなる形であれ装置に損傷が加わった場合は、装置の修理・点検を受けてください。



17. 本製品に電源コードが付属されている場合、付属の電源コードは本製品以外ではご使用いたしません。電源コードは必ず本製品に付属された電源コードのみご使用ください。

## 法的放棄

ここに含まれる記述、写真、意見の全体または一部に依拠して、いかなる人が損害を生じさせた場合にも、MUSIC Groupは一切の賠償責任を負いません。技術仕様、外観およびその他の情報は予告なく変更になる場合があります。商標はすべて、それぞれの所有者に帰属します。MIDAS、KLARK TEKNIK、TURBOSOUND、BEHRINGER、BUGERA および DDA は MUSIC Group IP Ltd. の商標または登録商標です。© MUSIC Group IP Ltd. 2014 無断転用禁止。

## 限定保証

適用される保証条件と MUSIC Group の限定保証に関する概要については、オンライン上 [music-group.com/warranty](http://music-group.com/warranty) にて詳細をご確認ください。

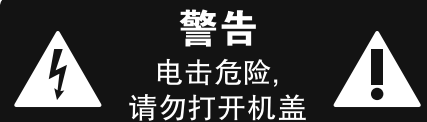
**CN 重要的安全须知**

 带有此标志的终端设备具有强大的电流, 存在触电危险。仅限使用带有 ¼" TS 或扭锁式插头的高品质专业扬声器线。所有的安装或调整均须由合格的专业人员进行。

 此标志提醒您, 产品内存在未绝缘的危险电压, 有触电危险。

 此标志提醒您查阅所附的重要的使用及维修说明。请阅读有关手册。

 **小心**  
为避免触电危险, 请勿打开机顶盖 (或背面挡板)。设备内没有可供用户维修使用的部件。请将维修事项交由合格的专业人员进行。

 **小心**  
为避免着火或触电危险, 请勿将此设备置于雨淋或潮湿中。此设备也不可受液体滴溅, 盛有液体的容器也不可置于其上, 如花瓶等。

 **小心**  
维修说明仅是给合格的专业维修人员使用的。为避免触电危险, 除了使用说明书提到的以外, 请勿进行任何其它维修。所有维修均须由合格的专业人员进行。

1. 请阅读这些说明。
2. 请妥善保存这些说明。
3. 请注意所有的警示。
4. 请遵守所有的说明。
5. 请勿在靠近水的地方使用本产品。
6. 请用干布清洁本产品。
7. 请勿堵塞通风口。安装本产品时请遵照厂家的说明。
8. 请勿将本产品安装在热源附近, 如暖气片, 炉子或其它产生热量的设备 (包括功放器)。
9. 请勿移除极性插头或接地插头的安全装置。接地插头是由两个插塞接点及一个接地头构成。若随货提供的插头不适合您的插座, 请找电工更换一个合适的插座。
10. 妥善保护电源线, 使其不被践踏或刺破, 尤其注意电源插头、多用途插座及设备连接处。

11. 请只使用厂家指定的附属设备和配件。



备倾倒是受伤。

13. 遇闪电雷鸣或长期不使用本设备时, 请拔出电源插头。

14. 所有维修均须由合格的维修人员进行。设备受损时需进行维修, 例如电源线或电源插头受损, 液体流入或异物落入设备内, 设备遭雨淋或受潮, 设备不能正常运作或被摔坏。

15. 本设备连接电源时一定要接地保护。



16. 若电源插头或器具耦合器用作断电装置, 应当保证它们处于随时可方便操作状态。

17. 本产品仅适用于海拔 2000 米以下地区, 本产品仅适用于非热带气候条件下。

**法律声明**

对于任何因在此说明书提到的全部或部分描述、图片或声明而造成的损失, MUSIC Group 不负任何责任。技术参数和外观若有更改, 恕不另行通知。所有的商标均为其各自所有者的财产。MIDAS, KLARK TEKNIK, TURBOSOUND, BEHRINGER, BUGERA 和 DDA 是 MUSIC Group IP Ltd. 公司的商标或注册商标。© MUSIC Group IP Ltd. 2014 版权所有。

**保修条款**

有关音乐集团保修的适用条款及其它相关信息, 请登陆 [music-group.com/warranty](http://music-group.com/warranty) 网站查看完整的详细信息。

Thank you for choosing a TURBOSOUND loudspeaker product for your application. If you would like further information about this or any other TURBOSOUND product, please visit our website at [turbosound.com](http://turbosound.com).

**Unpacking the Loudspeaker**

After unpacking the unit please check carefully for damage. If damage is found, please notify your supplier at once. You, the consignee, must instigate any claim. Please retain all packaging in case of future re-shipment.

**System Requirements – Passive and Bi-amped Loudspeakers**

TCS62-R 2-way loudspeaker operates as a passive system and requires only one amplifier channel.

The input signal is divided between the low-frequency and high-frequency drivers internally with a passive crossover.

TCS122-R and TCS152-R are switchable passive / bi-amp 2-way loudspeakers. Passive and bi-amp modes are controlled by an internal switch. Passive operation (full range or with a subwoofer) requires 1 amplifier channel and 1 controller channel. The input signal is divided between the low-frequency and high-frequency drivers internally with a passive crossover. Bi-amp operation (full range or with a subwoofer) requires 2 amplifier channels and 2 controller channels, one for low frequencies one for high frequencies. The input signal is divided between the low frequency and high frequency driver in the controller and the individual amplified signals are fed to the speaker input.

TCS218B-R subwoofer has a 4-wire input to allow operation in parallel or discrete modes. Parallel operation is achieved by wiring inputs 1 and 2 in parallel and requires only 1 amplifier channel and 1 controller channel. Discrete operation is achieved by wiring inputs 1 and 2 separately, requiring 2 amplifier channels and 2 controller channels.

TCS115B subwoofer operates as a passive system and requires only one amplifier channel.

Correct controller settings for all models, horn variants and operation with subwoofers can be downloaded from the website, and are also available as presents for the LMS series controllers.

TCS weather-resistant loudspeakers are equipped with a 2 metre 4-core cable tail for connection to your chosen cabling infrastructure, with the exception of TCS62-R and TCS115B-R, which use a 2-core cable tail. To avoid wasting amplifier power, you should use heavy-duty speaker cable, with a minimum wire size of 1.5 mm<sup>2</sup> (16 AWG), and preferably 2.5 mm<sup>2</sup> (14 AWG) for longer runs. Use larger wire sizes for TCS218B-R and speakers wired in parallel. For extreme cable lengths, be aware of cable impedance and resistive losses. Always observe the correct polarity.



## Amplifier Considerations

The TCS series loudspeakers are optimised for use with the TURBOSOUND T series amplifiers with the LMS series controllers. A full range of DSP settings to suit any configuration are provided for download on the TURBOSOUND website. The use of third party amplification and processing is only advised using the matrix of manual settings as well as the limiter calculator provided on the TURBOSOUND website. The TCS series loudspeaker enclosures should be driven by high quality power amplifiers designed for true professional use. Power amplifiers should be capable of delivering long term broadband power **equal to half the loudspeaker's peak power rating at its stated nominal impedance**. The use of underpowered amplifiers must be avoided as heavily clipped signals can cause permanent loudspeaker damage. Limiters, crossovers and equalisation points must be set in accordance with the settings provided on the TURBOSOUND website. This will ensure the optimum sound quality and long-term reliability as well as protection from damage.

2 meter 4-core cable tails are provided, allowing options for passive, bi-amp, parallel and discrete operation, with the exception of TCS62-R and TCS115B-R, which use a 2-core cable tail.

## Recommended Minimum Amplifier Power

Model	TCS62-R	TCS122-R		TCS152-R			TCS115B-R	TCS218B-R		
Mode	Passive	Passive	Bi-amp LF	Bi-amp LF	Passive	Bi-amp LF	Bi-amp HF	Passive		
Impedance	8 Ohms	8 Ohms	8 Ohms	6 Ohms	8 Ohms	8 Ohms	6 Ohms	8 Ohms		
Minimum Amplifier Power	Continuous RMS	175 W	600 W	600 W	75 W	600 W	600 W	75 W	500 W	1600 W
	Peak	700 W	2400 W	2400 W	750 W	2400 W	2400 W	750 W	2000 W	6400 W

## Outdoor Applications

TCS weather-resistant products are designed to provide robust protection against the elements when used outdoors in harsh environments. The cabinet is fully sealed inside and out, protected with a weather-resistant paint finish, and the plated and outdoor powder-coated perforated steel grille backed with reticulated foam resists the impact of showers. Hard wired speaker connection is made via a 4 or 2-core cable tail fitted through a weather-sealed cable gland mounted on an aluminium connector plate. Stainless steel external fixings are used throughout. Internally, the drivers are treated to resist moisture absorption while the internal corner brackets are zinc plated and outdoor powder-coated.

While TCS series loudspeakers with the "R" suffix are constructed for outdoor use, care should be taken when installing these loudspeakers outdoors in coastal areas where high salinity and extreme temperature variations are present in addition to high humidity and UV light exposure.

Loudspeakers must always be mounted with a downward angle. Do not allow loudspeakers to become fully immersed in water at any time. Routine inspection and maintenance programs must be carried out on a regular basis and parts replaced as necessary to provide continued satisfactory performance.

## Connections

### TCS62-R

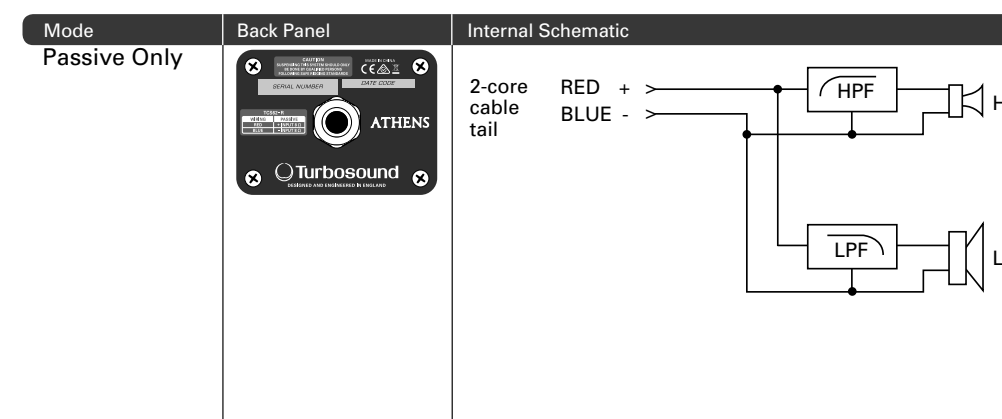

### TCS122-R, TCS152-R

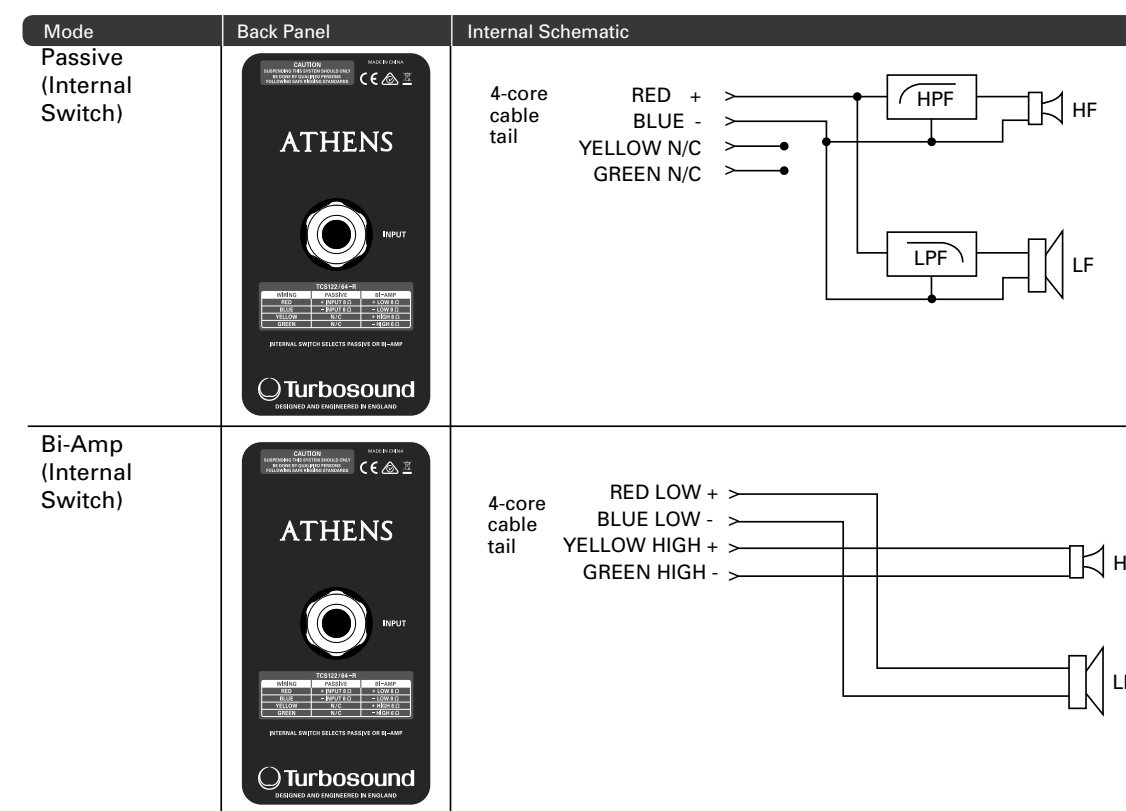

EN

TCS115B-R

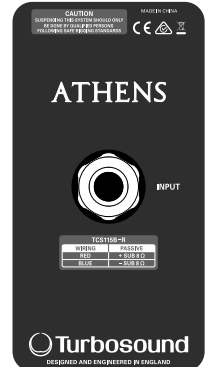
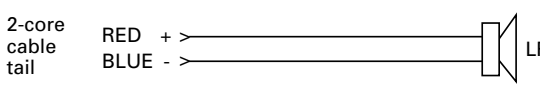
Mode	Back Panel	Internal Schematic
Passive		<p>2-core cable tail</p> <p>RED + &gt;</p> <p>BLUE - &gt;</p>  <p>LF</p>

TCS218B-R

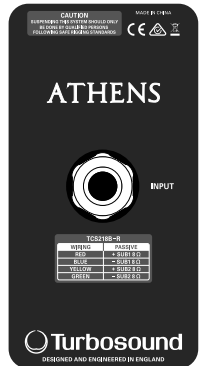
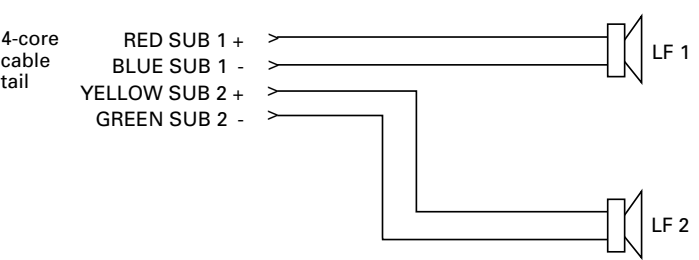
Mode	Back Panel	Internal Schematic
Parallel or Discrete are configured with external connection		<p>4-core cable tail</p> <p>RED SUB 1 + &gt;</p> <p>BLUE SUB 1 - &gt;</p> <p>YELLOW SUB 2 + &gt;</p> <p>GREEN SUB 2 - &gt;</p>  <p>LF 1</p> <p>LF 2</p>

## Mounting and Fixing

The table below summarises the rigging parts or kits required for various applications, and some examples of the possible rigging options are illustrated.

TCS series cabinets are designed with multiple internal rigging points to suit many possible mounting methods in permanent installations. All cabinets can be simply suspended using optional M8 or M10 shoulder eyebolts coupled to the internal rigging points provided. Remove the appropriate countersunk screws and replace them with eyebolts, which must have a thread length of at least 18mm. Use the rear rigging point to angle the cabinet for optimum room coverage. Cabinets may be hung upside down if required. Turbosound WB-20, WB-55 and CB-55 wall and ceiling brackets are optionally available for TCS series cabinets, and these are also compatible with OmniMount\* wall and ceiling brackets which use 60 mm x 60 mm hole spacing.

Model	Wall	Ceiling	Downfill	Array Kit	Eyebolts
TCS62-R	WB-20 TCS62-SB	CB-55 TCS62-SB	TCS62-SB		M8 Thread
TCS122-R	WB-55	CB-55		TCS122-FP TCS-FK1 TCS-FK2	EB-10-40
TCS152-R	WB-55	CB-55		TCS152-FP TCS-FK1 TCS-FK2	EB-10-40
TCS115B-R				TCS115-FP TCS-FK3	EB-10-40
TCS-R Subwoofers					EB-10-40

Some typical examples of the possible rigging options are shown here:

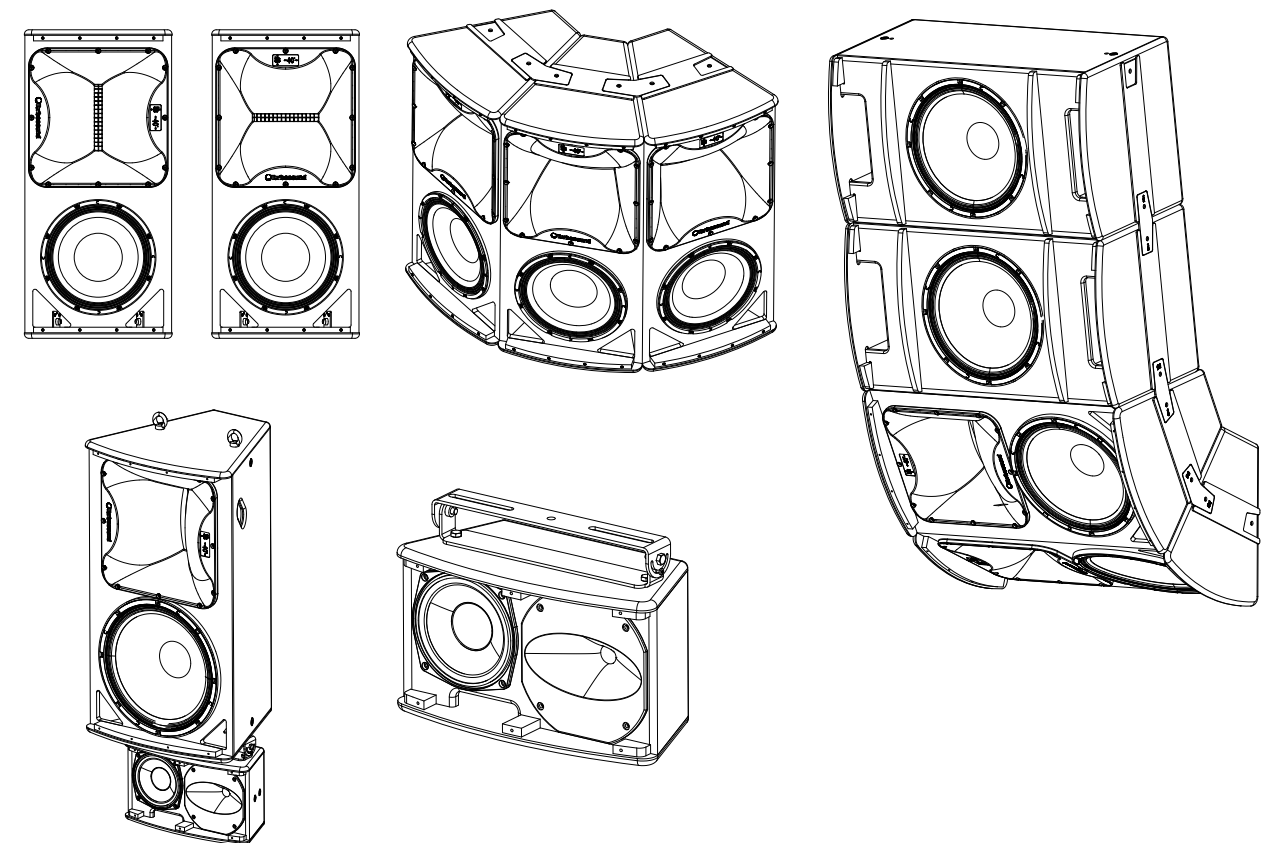

EN

# EN TCS Series Flying Components

## Wall and Ceiling Brackets

To install a loudspeaker using Turbosound wall and ceiling brackets, first separate the brackets into their wall/ceiling plate and speaker plate component parts. Remove the countersunk bolts on the rear panel of the cabinet. Attach the speaker plate to the cabinet with the bolts supplied. Fix the wall/ceiling plate in the venue using appropriate fixings (not supplied). Lift the loudspeaker on to the wall plate and re-assemble the bracket parts, adjust the vertical angle and tighten all bolts.

## Downfill Applications

The TCS62-R can be mounted underneath a TCS122-R or TCS152-R cabinet to provide downfill coverage using the TCS62-SB swivel bracket. First disassemble the swivel bracket into its component parts. Remove the countersunk bolts from the bottom panel of the TCS152-R cabinet and fit the section with the elongated holes using the fixings supplied. Remove the countersunk bolts on the top panel and fit the swivel bracket using the supplied fixings. Re-assemble the swivel bracket, angle as appropriate and tighten all fixings.

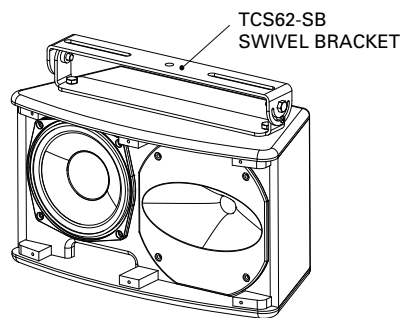

To install the TCS62-R in a ceiling-mount application, separate the component parts as above, and fix the top section to the ceiling with appropriate fixings (not supplied). Fit the other half to the TCS62-R cabinet, re-assemble the bracket, angle as appropriate and tighten all fixings.

## Loudspeaker Arrays and Clusters

An array of two or more cabinets requires the use of kits of flyplates and inter-cabinet couplers, which are fixed to the cabinet sides through the M10 rigging points and assembled together in a 'daisy chain' fashion to build up the required array. For all loudspeaker arrays consisting of two or more cabinets:

**The number of inter cabinet coupler kits required = the number of boxes – 1, The number of flyplate kits required = the number of boxes.**

Illustrated here are the components parts available for TCS cabinets:

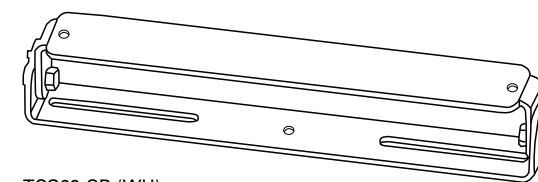

TCS62-SB (WH)  
Swivel bracket for TCS62-R

Contents:

- 1 x Bracket
- 2 x M8 Bolts
- 2 x M8 Spring Washers
- 2 x M8 Flat Washers
- 2 x M10 Bolts
- 2 x M10 Spring Washers
- 2 x M10 Flat Washers

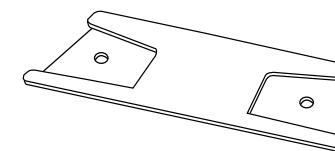

TCS122-FP (WH)  
Fly Plate Kit for TCS122-R

Contents:

- 2 x Fly Plates
- 4 x M10 Bolts
- 4 x M10 Spring Washers
- 4 x M10 Flat Washers

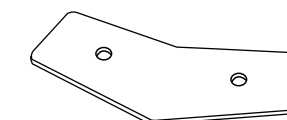

TCS-FK1 (WH)  
Inter-Cabinet Coupler Kit for TCS122-R or TCS152-R

Contents:

- 2 x ICC

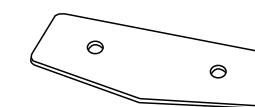

TCS-FK2 (WH)  
Inter-Cabinet Coupler Kit for TCS122-R or TCS152-R

Contents:

- 2 x ICC

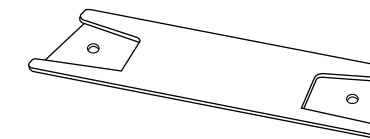

TCS152-FP (WH)  
Fly Plate Kit for TCS152-R

Contents:

- 2 x Fly Plates
- 4 x M10 Bolts
- 4 x M10 Spring Washers
- 4 x M10 Flat Washers

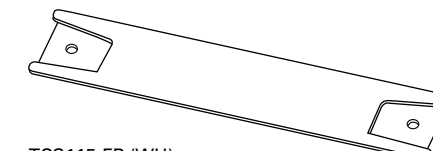

TCS115-FP (WH)  
Fly Plate Kit for TCS115B-R

Contents:

- 2 x Fly Plates
- 4 x M10 Bolts
- 4 x M10 Spring Washers
- 4 x M10 Flat Washers

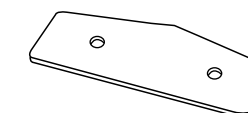

TCS-FK3 (WH)  
Inter-Cabinet Coupler Kit for TCS115B-R

Contents:

- 2 x ICC



EB-10-40  
Eyebolt M10 x 40mm

Contents:

- 1 x Eyebolt



EN

## Suspending with Eyebolts

TCS cabinets can be suspended using optional eyebolts coupled to the internal rigging points provided on the top, bottom and sides and back. The simplest method is to use the two rigging points on the top and a single pull-back rigging point in the centre of the rear panel.

Remove the appropriate countersunk screws and replace them with shoulder eyebolts, which must have a thread length of at least 18 mm. Use the rear rigging point to angle the cabinet for optimum room coverage. Cabinets may be hung upside down if required.

**IMPORTANT NOTE FOR ALL INSTALLATION METHODS:** The mounting of a permanently installed sound system may be dangerous unless undertaken by qualified personnel with the required experience and certification to perform the necessary tasks. Walls, floors or ceilings must be capable of safely and securely supporting the actual load. The mounting accessory used must be safely and securely fixed both to the loudspeaker and to the wall, floor or ceiling.

When mounting rigging components on walls, floors or ceilings, ensure that all fixings and fasteners used are of an appropriate size and load rating. Wall and ceiling claddings, and the construction and composition of walls and ceilings, all need to be taken into account when determining whether a particular fixing arrangement can be safely employed for a particular load. Cavity plugs or other specialist fixings, if required, must be of an appropriate type, and must be fitted and used in accordance with the maker's instructions.

The operation of your speaker cabinet as part of a flown system, if installed incorrectly and improperly, can potentially expose persons to serious health risks and even death. In addition, please ensure that electrical, mechanical and acoustic considerations are discussed with qualified and certified (by local state or national authorities) personnel prior to any installation or flying.

Make sure that speaker cabinets are set up and flown by qualified and certified personnel only, using dedicated equipment and original parts and components delivered with the unit. If any parts or components are missing please contact your Dealer before attempting to set up the system.

Be sure to observe the local, state and other safety regulations applicable in your country. MUSIC Group, including the MUSIC Group companies listed on the enclosed "Service Information Sheet", assumes no liability for any damage or personal injury resulting from improper use, installation or operation of the product. Regular checks must be conducted by qualified personnel to ensure that the system remains in a secure and stable condition. Make sure that, where the speaker is flown, the area underneath the speaker is free of human traffic. Do not fly the speaker in areas that can be entered or used by members of the public.

Speakers create a magnetic field, even if not in operation. Therefore, please keep all materials that can be affected by such fields (discs, computers, monitors, etc) at a safe distance. A safe distance is usually between 1 and 2 metres.

## Rotating the HF horn pattern

The high frequency horn in all TCS122-R and TCS152-R models can be rotated through 90° in order to swap the horizontal and vertical dispersion patterns, particularly useful when assembling clusters or for example to retain the original dispersion when the cabinet is installed in a horizontal orientation.

1. Place the cabinet on its back on a suitable work surface. Take care of the protruding cable gland.
2. Remove the 10 posi-drive screws that hold the grille in place and set the grille aside (fig 1).
3. Remove and disconnect the bass driver (fig 2) to access the compression driver retaining brace, making a note of the bass driver polarity for later reconnection.
4. Reach in through the bass driver cavity and loosen the two wing nuts securing the compression driver retaining brace (fig 3).
5. Remove the horn fixing screws that secure the horn to the enclosure and lift out the horn and compression driver assembly (fig 4). (If required for servicing or replacement, disconnect the cables from the compression driver, making a note of the polarity for later reconnection.)
6. Rotate the horn to achieve the desired coverage pattern (fig 5).
7. Re-assemble the cabinet and drivers by reversing steps 1-5.
8. If the compression driver cables have been disconnected, reconnect the cables while observing the correct polarity (white cable to the +ve terminal, black cable to the -ve terminal).
9. Place the horn and compression driver back into the cabinet, making sure that the driver cables pass underneath the compression driver retainer and that the compression driver fits squarely back into the retaining brace.
10. Tighten the wing nuts back onto the compression driver retaining brace (fig 3).
11. Replace the horn fixing screws and tighten to secure the horn back into the enclosure (fig 4).
12. Reconnect the bass driver cables, observing the correct polarity (red cable to the +ve terminal, blue cable to the -ve terminal).
13. Check all components and confirm the horn orientation is correct (fig 6).
14. Replace the grille (fig 1) and phase check the cabinet before use.

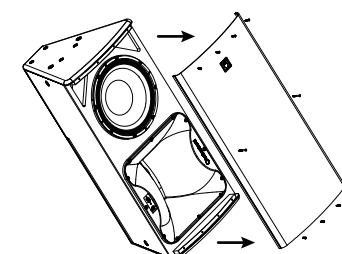

Fig. 1

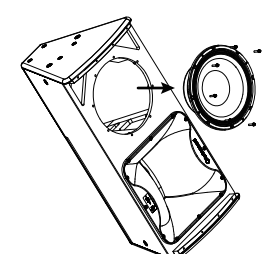

Fig. 2

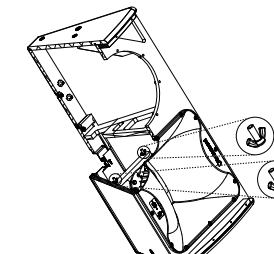

Fig. 3

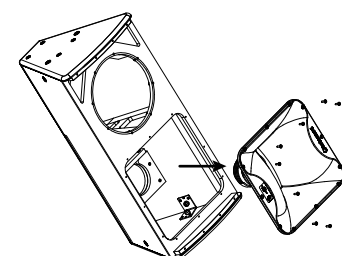

Fig. 4

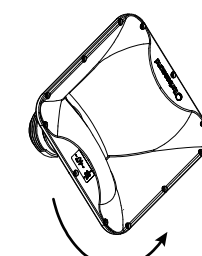

Fig. 5

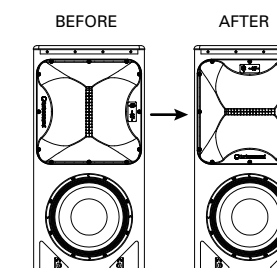

Fig. 6

EN

# Technical Specifications

	TCS62-R (-WH)	TCS122/64-R (-WH)	TCS122/94-R (-WH)
<b>System</b>			
<b>Frequency response</b>	60 Hz - 20 kHz ±3 dB 50 Hz - 20 kHz -10 dB	50 Hz - 18 kHz ±3 dB 45 Hz - 20 kHz -10 dB	50 Hz - 18 kHz ±3 dB 45 Hz - 20 kHz -10 dB
<b>Nominal dispersion</b>	100° H x 60° V @ -6dB points, rotatable	60° H x 40° V @ -6 dB points, rotatable	90° H x 40° V @ -6 dB points, rotatable
<b>Directivity factor (Q)</b>	12.8	18.3	12.9
<b>Directivity index (DI)</b>	11.1	12.6	11.1
<b>Power handling (IEC)</b>			
Passive	175 W continuous, 700 W peak	600 W continuous, 2400 W peak	600 W continuous, 2400 W peak
Bi-amp	-	LF:600 W continuous, 2400 W peak HF:75 W continuous, 300 W peak	LF:600 W continuous, 2400 W peak HF:75 W continuous, 300 W peak
<b>Sensitivity</b>	90 dB (1 W @ 1 m)	96 dB (1 W @ 1 m)	96 dB (1 W @ 1 m)
<b>Maximum SPL</b>			
Passive	112.5 dB continuous, 118.5 dB peak	124 dB continuous, 130 dB peak	124 dB continuous, 130 dB peak
Bi-amp	-	LF: 124 dB continuous, 130 dB peak HF: 128 dB continuous, 134 dB peak	LF: 124 dB continuous, 130 dB peak HF: 128 dB continuous, 134 dB peak
<b>Impedance</b>			
Passive	8 Ω	8 Ω	8 Ω
Bi-amp	-	LF: 8 Ω HF: 6 Ω	LF: 8 Ω HF: 6 Ω
<b>Crossover type</b>	Passive	Passive / Bi-amp, internally switchable	Passive / Bi-amp, internally switchable
<b>Components</b>	1 x 6" (162 mm) LF driver 1 x 1" (25 mm) HF compression driver	1 x 12" (312 mm) LF driver 1 x 1.4" (36 mm) HF compression driver	1 x 12" (312 mm) LF driver 1 x 1.4" (36 mm) HF compression driver
<b>Enclosure</b>			
<b>Connectors</b>	2-core captive cable tail	4-core captive cable tail	4-core captive cable tail
<b>Wiring</b>			
Passive	Red/Blue input + / -	Red/Blue input + / -, Yellow/Green NC	Red/Blue input + / -, Yellow/Green NC
Bi-amp	-	Red/Blue LF + / -, Yellow/Green HF + / -	Red/Blue LF + / -, Yellow/Green HF + / -
<b>Dimensions (HWD)</b>	224 x 402 x 198 mm (18.8 x 15.8 x 7.8")	834 x 399 x 425 mm (32.8 x 15.7 x 16.7")	834 x 399 x 425 mm (32.8 x 15.7 x 16.7")
<b>Net weight</b>	7.3 kg (16.1 lbs)	26.9 kg (59.3 lbs)	26.9 kg (59.3 lbs)
<b>Construction</b>	12 mm (½") birch plywood	15 mm (⅝") birch plywood	15 mm (⅝") birch plywood
<b>Finish</b>	Semi matt black paint (white optional)	Semi matt black paint (white optional)	Semi matt black paint (white optional)
<b>Grille</b>	Powder-coated perforated steel	Powder-coated perforated steel	Powder-coated perforated steel
<b>Flying hardware</b>	M8 X 8, M6 X 2 Points	M10 x 9, M8 X 8 Points	M10 x 9, M8 X 8 Points
<b>Accessories</b>			
	TCS62-SB (WH) swivel bracket for TCS62	TCS122-FP (WH) fly plate kit for TCS122 TCS-FK1 (WH) inter-cabinet coupler kit for TCS122 or TCS152 TCS-FK2 (WH) inter-cabinet coupler kit for TCS115B with TCS122 or TCS152	TCS122-FP (WH) fly plate kit for TCS122 TCS-FK1 (WH) inter-cabinet coupler kit for TCS122 or TCS152 TCS-FK2 (WH) inter-cabinet coupler kit for TCS115B with TCS122 or TCS152

	TCS122/96-R (-WH)	TCS152/64-R (-WH)	TCS152/94-R (-WH)	TCS152/96-R (-WH)
<b>System</b>				
<b>Frequency response</b>	50 Hz - 18 kHz ±3 dB 45 Hz - 20 kHz -10 dB	41 Hz - 18 kHz ±3 dB 35 Hz - 20 kHz -10 dB	41 Hz - 18 kHz ±3 dB 35 Hz - 20 kHz -10 dB	41 Hz - 18 kHz ±3 dB 35 Hz - 20 kHz -10 dB
<b>Nominal dispersion</b>	90° H x 60° V @ -6 dB points, rotatable	60° H x 40° V @ -6 dB points, rotatable	90° H x 40° V @ -6 dB points, rotatable	90° H x 60° V @ -6 dB points, rotatable
<b>Directivity factor (Q)</b>	8.7	18.3	12.9	8.7
<b>Directivity index (DI)</b>	9.4	12.6	11.1	9.4
<b>Power handling (IEC)</b>				
Passive	600 W continuous, 2400 W peak	600 W continuous, 2400 W peak	600 W continuous, 2400 W peak	600 W continuous, 2400 W peak
Bi-amp	LF:600 W continuous, 2400 W peak HF:75 W continuous, 300 W peak	LF:600 W continuous, 2400 W peak HF:75 W continuous, 300 W peak	LF:600 W continuous, 2400 W peak HF:75 W continuous, 300 W peak	LF:600 W continuous, 2400 W peak HF:75 W continuous, 300 W peak
<b>Sensitivity</b>	96 dB (1 W @ 1 m)	97 dB (1 W @ 1 m)	97 dB (1 W @ 1 m)	97 dB (1 W @ 1 m)
<b>Maximum SPL</b>				
Passive	124 dB continuous, 130 dB peak	125 dB continuous, 131 dB peak	125 dB continuous, 131 dB peak	125 dB continuous, 131 dB peak
Bi-amp	LF: 124 dB continuous, 130 dB peak HF: 128 dB continuous, 134 dB peak	LF: 125 dB continuous, 131 dB peak HF: 128 dB continuous, 134 dB peak	LF: 125 dB continuous, 131 dB peak HF: 128 dB continuous, 134 dB peak	LF: 125 dB continuous, 131 dB peak HF: 128 dB continuous, 134 dB peak
<b>Impedance</b>				
Passive	8 Ω	8 Ω	8 Ω	8 Ω
Bi-amp	LF: 8 Ω HF: 6 Ω	LF: 8 Ω HF: 6 Ω	LF: 8 Ω HF: 6 Ω	LF: 8 Ω HF: 6 Ω
<b>Crossover type</b>	Passive / Bi-amp, internally switchable	Passive / Bi-amp, internally switchable	Passive / Bi-amp, internally switchable	Passive / Bi-amp, internally switchable
<b>Components</b>	1 x 12" (312 mm) LF driver 1 x 1.4" (36 mm) HF compression driver	1 x 15" (394 mm) LF driver 1 x 1.4" (36 mm) HF compression driver	1 x 15" (394 mm) LF driver 1 x 1.4" (36 mm) HF compression driver	1 x 15" (394 mm) LF driver 1 x 1.4" (36 mm) HF compression driver
<b>Enclosure</b>				
<b>Connectors</b>	4-core captive cable tail	4-core captive cable tail	4-core captive cable tail	4-core captive cable tail
<b>Wiring</b>				
Passive	Red/Blue input + / -, Yellow/Green NC	Red/Blue input + / -, Yellow/Green NC	Red/Blue input + / -, Yellow/Green NC	Red/Blue input + / -, Yellow/Green NC
Bi-amp	Red/Blue LF + / -, Yellow/Green HF + / -	Red/Blue LF + / -, Yellow/Green HF + / -	Red/Blue LF + / -, Yellow/Green HF + / -	Red/Blue LF + / -, Yellow/Green HF + / -
<b>Dimensions (HWD)</b>	834 x 399 x 425 mm (32.8 x 15.7 x 16.7")	834 x 473 x 451 mm (32.8 x 18.6 x 17.8")	834 x 473 x 451 mm (32.8 x 18.6 x 17.8")	834 x 473 x 451 mm (32.8 x 18.6 x 17.8")
<b>Net weight</b>	26.9 kg (59.3 lbs)	28.6 kg (63.1 lbs)	28.6 kg (63.1 lbs)	28.6 kg (63.1 lbs)
<b>Construction</b>	15 mm (⅝") birch plywood	15 mm (⅝") birch plywood	15 mm (⅝") birch plywood	15 mm (⅝") birch plywood
<b>Finish</b>	Semi matt black paint (white optional)	Semi matt black paint (white optional)	Semi matt black paint (white optional)	Semi matt black paint (white optional)
<b>Grille</b>	Powder-coated perforated steel	Powder-coated perforated steel	Powder-coated perforated steel	Powder-coated perforated steel
<b>Flying hardware</b>	M10 x 9, M8 X 8 Points	M10 x 9, M8 X 8 Points	M10 x 9, M8 X 8 Points	M10 x 9, M8 X 8 Points
<b>Accessories</b>				
	TCS122-FP (WH) fly plate kit for TCS122 TCS-FK1 (WH) inter-cabinet coupler kit for TCS122 or TCS152 TCS-FK2 (WH) inter-cabinet coupler kit for TCS115B with TCS122 or TCS152	TCS152-FP (WH) fly plate kit for TCS152 TCS-FK1 (WH) inter-cabinet coupler kit for TCS122 or TCS152 TCS-FK2 (WH) inter-cabinet coupler kit for TCS115B with TCS122 or TCS152	TCS152-FP (WH) fly plate kit for TCS152 TCS-FK1 (WH) inter-cabinet coupler kit for TCS122 or TCS152 TCS-FK2 (WH) inter-cabinet coupler kit for TCS115B with TCS122 or TCS152	TCS152-FP (WH) fly plate kit for TCS152 TCS-FK1 (WH) inter-cabinet coupler kit for TCS122 or TCS152 TCS-FK2 (WH) inter-cabinet coupler kit for TCS115B with TCS122 or TCS152

# EN Technical Specifications

	TCS115B-R (-WH)	TCS218B-R (-WH)
<b>System</b>		
<b>Frequency response</b>	45 Hz - 150 Hz ± 3 dB 40 Hz - 200 Hz - 10 dB	33 Hz - 200 Hz ± 3 dB 27 Hz - 200 Hz - 10 dB
<b>Nominal dispersion</b>	Half space	Half space
<b>Power handling (IEC)</b>	500 W continuous, 2000 W peak	1600 W continuous, 6400 W peak
<b>Sensitivity</b>	97 dB (1 W @ 1 m)	99 dB (1 W @ 1 m)
<b>Maximum SPL</b>	124 dB continuous, 130 dB peak	131 dB continuous, 137 dB peak
<b>Impedance</b>	8 Ω	Parallel: 4 Ω Discrete: 8 Ω x 2
<b>Components</b>	1 x 15" (387 mm) LF driver	2 x 18" (460 mm) LF driver
<b>Enclosure</b>		
<b>Connectors</b>	2-core captive cable tail	4-core captive cable tail
<b>Wiring</b>		
Parallel / No switch	Red/Blue input + / -	Red/Blue input + / -, Yellow/Green link + / -
Discrete	-	Red/Blue input 1 + / -, Yellow/Green input 2 + / -
<b>Dimensions (HWD)</b>	834 x 469 x 452 mm (32.9 x 18.5 x 17.8")	1130 x 710 x 730 mm (44.5 x 28.0 x 28.8")
<b>Net weight</b>	33.9 kg (74.7 lbs)	94 kg (207.2 lbs)
<b>Construction</b>	15 mm (5/8") birch plywood	18 mm (5/8") birch plywood
<b>Finish</b>	Semi matt black paint (white optional)	Semi matt black paint (white optional)
<b>Grille</b>	Powder-coated perforated steel	Powder-coated perforated steel
<b>Flying hardware</b>	M10 x 8	M10 x 8
<b>Accessories</b>		
	TCS115-FP (WH) fly plate kit for TCS115B TCS-FK2 (WH) inter-cabinet coupler kit for TCS115B with TCS122 or TCS152 TCS-FK3 (WH) inter-cabinet coupler kit for TCS115B	

# Other important information

## EN Important information

- 1. Register online.** Please register your new MUSIC Group equipment right after you purchase it by visiting [turbosound.com](http://turbosound.com). Registering your purchase using our simple online form helps us to process your repair claims more quickly and efficiently. Also, read the terms and conditions of our warranty, if applicable.
- 2. Malfunction.** Should your MUSIC Group Authorized Reseller not be located in your vicinity, you may contact the MUSIC Group Authorized Fulfiller for your country listed under "Support" at [turbosound.com](http://turbosound.com). Should your country not be listed, please check if your problem can be dealt with by our "Online Support" which may also be found under "Support" at [turbosound.com](http://turbosound.com). Alternatively, please submit an online warranty claim at [turbosound.com](http://turbosound.com) BEFORE returning the product.
- 3. Power Connections.** Before plugging the unit into a power socket, please make sure you are using the correct mains voltage for your particular model. Faulty fuses must be replaced with fuses of the same type and rating without exception.

