

Portable

SIENA

TSP152-AN

2500 Watt 2 Way 15" Powered Loudspeaker with KLARK TEKNIK DSP Technology and ULTRANET Networking

- 2 way full range loudspeaker for portable PA applications
- 2,500 Watt power featuring KLARK TEKNIK Class-D technology
- KLARK TEKNIK Digital Signal Processing for total system control
- ULTRANET digital audio networking connects to mixers and other sources
- 15" low frequency driver with inside/outside wound coil for high power handling
- Titanium dome 1" compression driver with extended high frequency reproduction
- Fully featured user interface with LCD display for ease of navigation
- PC remote control software downloadable at turbosound.com
- Low distortion waveguide provides 70° H x 50° V dispersion
- 18 mm (¾") birch plywood enclosure, finished in a black semi-matt textured paint
- Rugged powder coated perforated steel mesh grille
- Dual angle pole mount for accurate coverage control
- Multiple internal rigging points for install applications
- Mains input on Neutrik powerCON* connectors
- 10-Year Warranty Program*
- Designed and engineered in the U.K.



The 2-way full range TSP152-AN is a 2,500 Watt 15" powered loudspeaker system that is ideally suited for a wide range of portable and fixed installation speech and music sound reinforcement applications. Designed to work individually without a controller, the TSP152-AN provides optimal performance for FOH, sidefill and delay line loudspeakers, and is an exceptional choice for wedge monitoring applications. It also offers the flexibility to accommodate venue-specific requirements for install applications.



Custom-Engineered Drivers

TURBOSOUND is recognised the world over for designing and building some of the most iconic loudspeakers and subwoofers. We take meticulous care and pride in maintaining that reputation by utilising only drivers designed specifically for each application – it's what sets us apart from the competition. The TSP152-AN loudspeaker features a 15" low frequency driver with an inside/outside wound low mass voice coil for improved transient response and an titanium dome 1" high frequency compression driver, which is mounted on a 70° horizontal by 50° vertical dispersion low distortion waveguide.

*All third-party trademarks are the property of their respective owners. Their use neither constitutes a claim of the trademark nor affiliation of the trademark owners with MUSIC Tribe. Product names are mentioned solely as a reference for compatibility, effects and/or components. Warranty details can be found at musictribe.be.

Portable

SIENA TSP152-AN

2500 Watt 2 Way 15" Powered Loudspeaker
with KLARK TEKNIK DSP Technology and
ULTRANET Networking

Class-D – Massive Power, Perfect Sound

Equipped with a very efficient and lightweight **KLARK TEKNIK** Class-D power amplifier, the TSP152-AN provides an impressive 2,500 Watts of output power in a highly portable and lightweight package. Class-D amplification makes all the difference, offering the ultimate in energy efficiency and eliminating the need for heavy power supplies and large heat sinks.

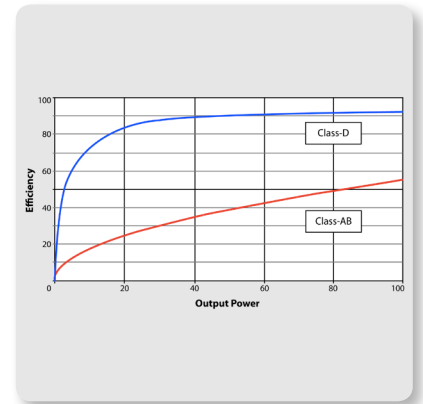

Onboard DSP

A high degree of control over the loudspeaker system's performance is managed by a sophisticated, but easy to use **KLARK TEKNIK** Digital Signal Processor (DSP), which provides dynamic EQ and transparent limiting for the utmost punch and definition at high output levels – and long-term reliability.

Intuitive User Interface

On the rear panel of the amplifier module, the user interface's LCD display and single rotary encoder provide intuitive access to: position compensation, user EQ control, subwoofer integration and signal routing features. In addition to the balanced XLR input, an XLR output is provided for daisy-chaining more active loudspeakers or for use with active subwoofers. An onboard USB port provides access for remote control of the TSP152-AN via a free PC computer software download from turbosound.com – as well as convenient DSP firmware updates.



Portable

SIENA TSP152-AN

2500 Watt 2 Way 15" Powered Loudspeaker
with KLARK TEKNIK DSP Technology and
ULTRANET Networking



ULTRANET Connectivity

ULTRANET connectivity is provided by two locking etherCON* connectors. Up to 16 independent channels of 24-bit digital audio and control data are transmitted via a single CAT5 cable between compatible digital devices – including mixers, I/O stage boxes, powered loudspeakers and personal monitoring systems. Simplified cable routing and ease of setup translate directly into significant time saved during installation.

Birch Plywood Construction

Finished in a highly durable semi matt black paint, the cabinet is constructed from 18 mm (¾") birch plywood – and includes a rugged powder coated perforated steel mesh grille backed with reticulated foam. Multiple threaded rigging points are provided for suspension in any orientation, a dual-angle pole mount socket for use with 35 mm poles/speaker stands to optimise audience coverage, and durable handles for easy transport. The wedge shape design also enables the TSP152-AN to be utilised in low profile stage monitor applications where improved audience line of sight is of paramount importance. Mains power input is provided via a Neutrik powerCON* connector.



Touring-Grade Performance

Designed to provide exceptional performance for traveling musicians, or permanent installations such as houses of worship, banquet facilities, night clubs – and a host of other venues, the 2,500-Watt Siena TSP152-AN puts touring-grade sound quality into a scalable loudspeaker system that is supremely portable and versatile.

Portable

SIENA TSP152-AN

2500 Watt 2 Way 15" Powered Loudspeaker
with KLARK TEKNIK DSP Technology and
ULTRANET Networking

You Are Covered

We always strive to provide the best possible Customer Experience. Our products are made in our own [MUSIC Tribe](#) factory using state-of-the-art automation, enhanced production workflows and quality assurance labs with the most sophisticated test equipment available in the world. As a result, we have one of the lowest product failure rates in the industry, and we confidently back it up with a generous [Warranty program](#).



Portable

SIENA TSP152-AN

2500 Watt 2 Way 15" Powered Loudspeaker
with KLARK TEKNIK DSP Technology and
ULTRANET Networking

Frequency Response Sensitivity 1 W / 1 m

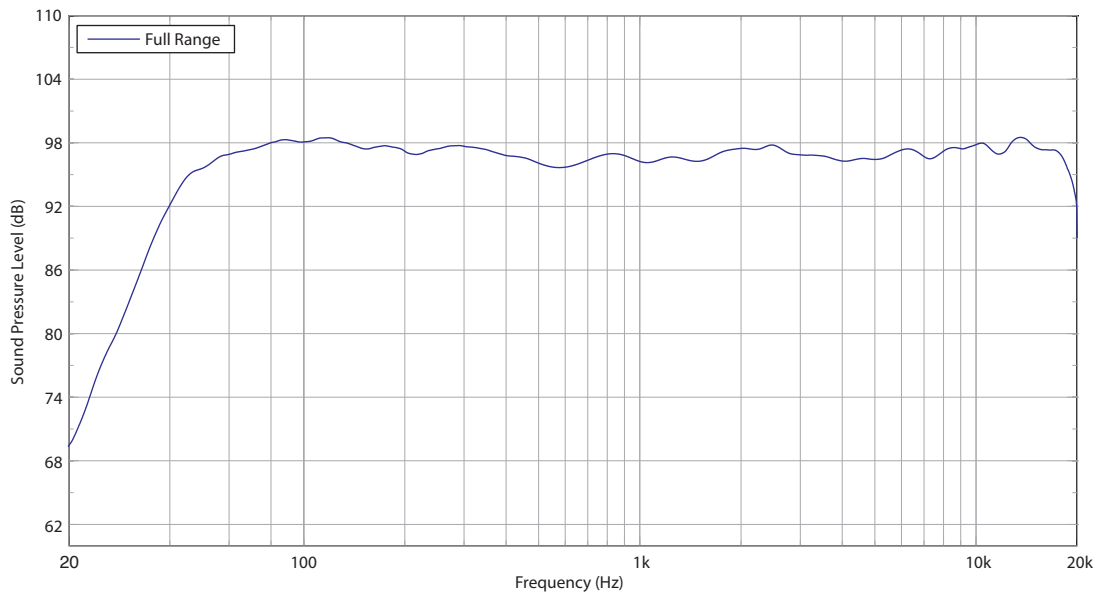

Portable

SIENA TSP152-AN

2500 Watt 2 Way 15" Powered Loudspeaker
with KLARK TEKNIK DSP Technology and
ULTRANET Networking

Horizontal Beamwidth

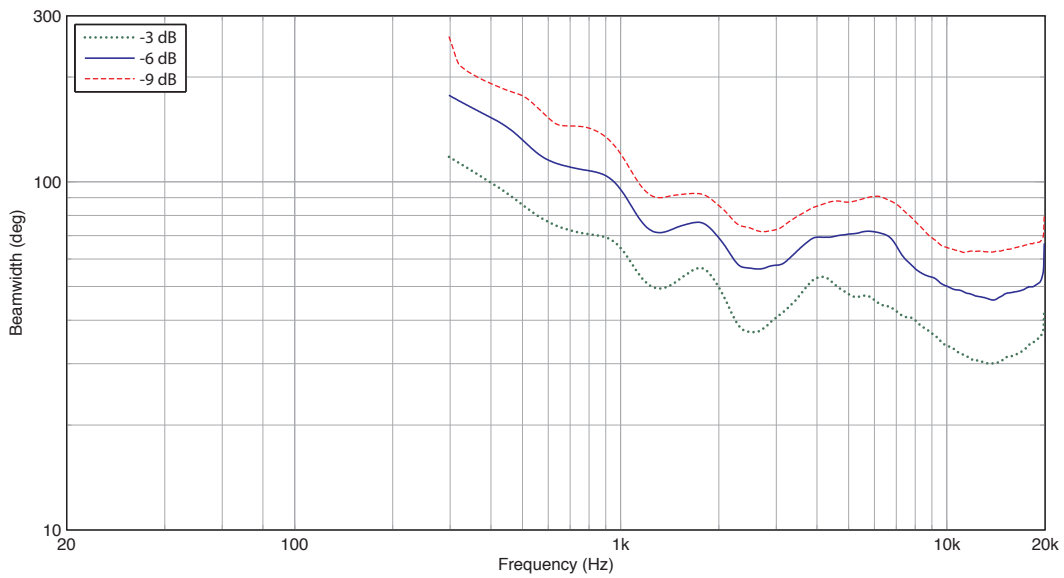

Vertical Beamwidth

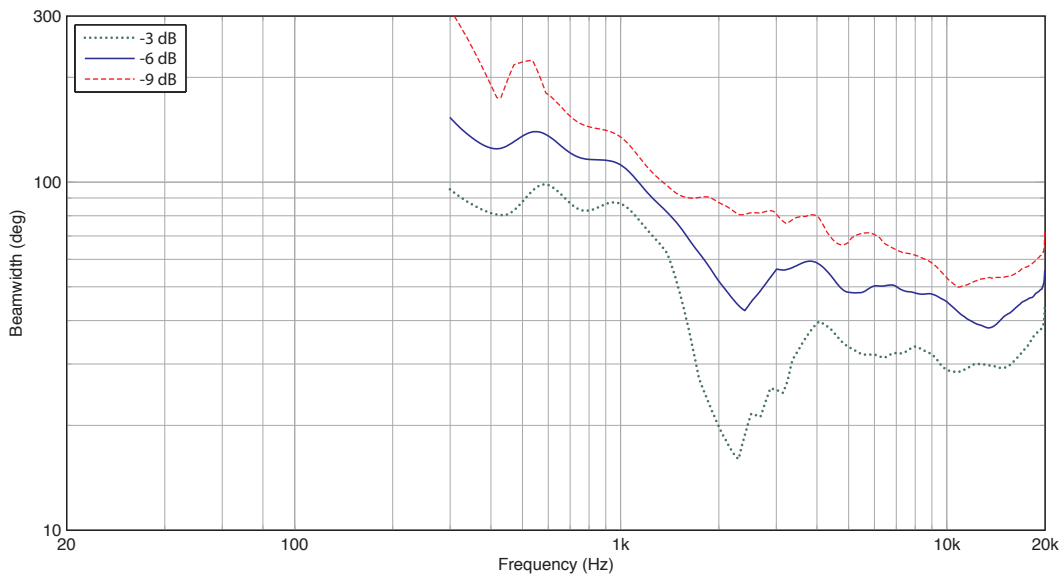

Portable

SIENA TSP152-AN

2500 Watt 2 Way 15" Powered Loudspeaker
with KLARK TEKNIK DSP Technology and
ULTRANET Networking

Horizontal Polar Plots

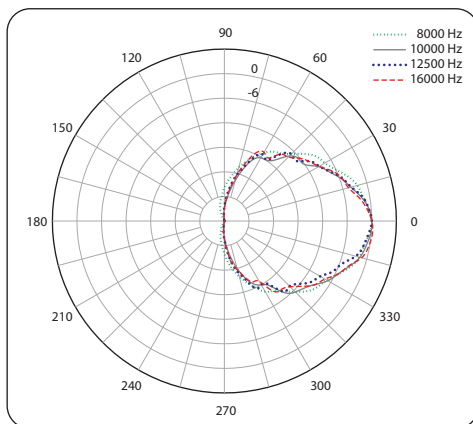
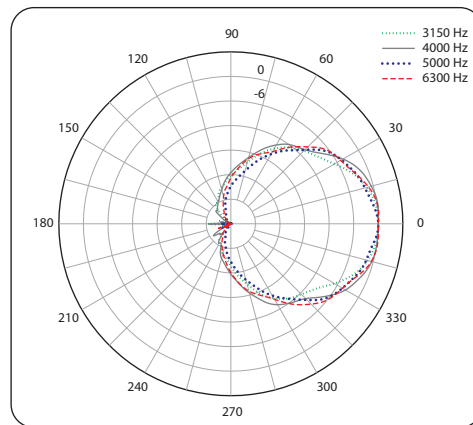
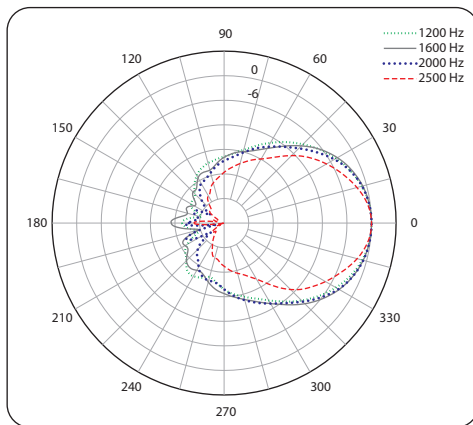
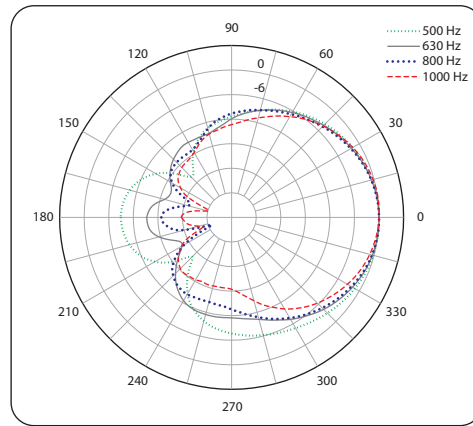
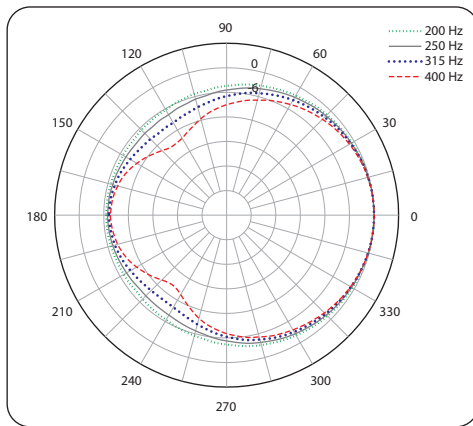

Portable

SIENA TSP152-AN

2500 Watt 2 Way 15" Powered Loudspeaker
with KLARK TEKNIK DSP Technology and
ULTRANET Networking

Vertical Polar Plots

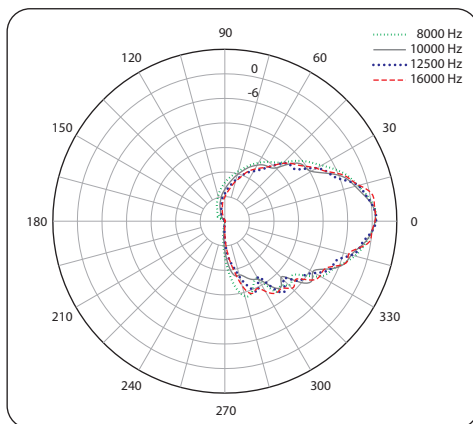
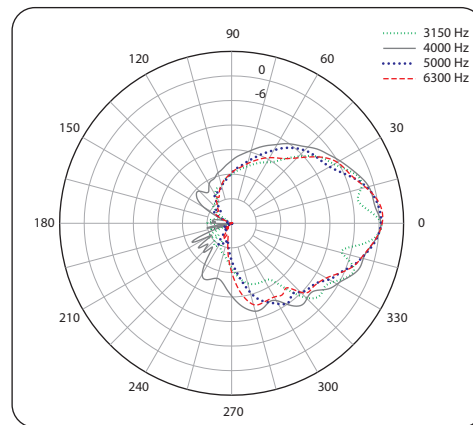
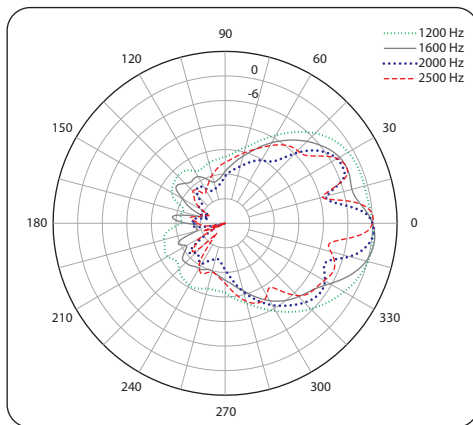
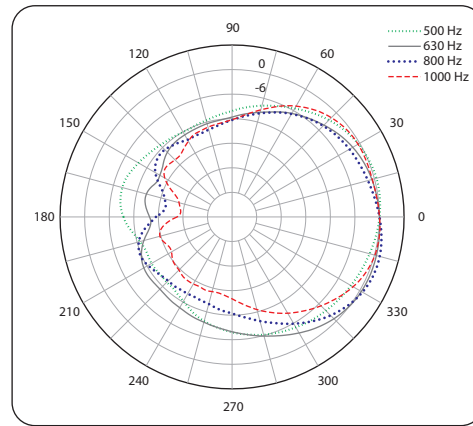
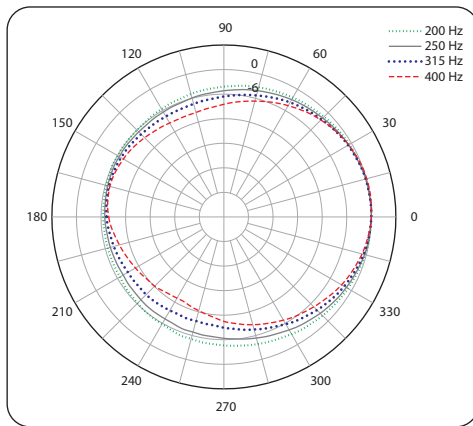

Portable

SIENA TSP152-AN

2500 Watt 2 Way 15" Powered Loudspeaker
with KLARK TEKNIK DSP Technology and
ULTRANET Networking

Dimensions

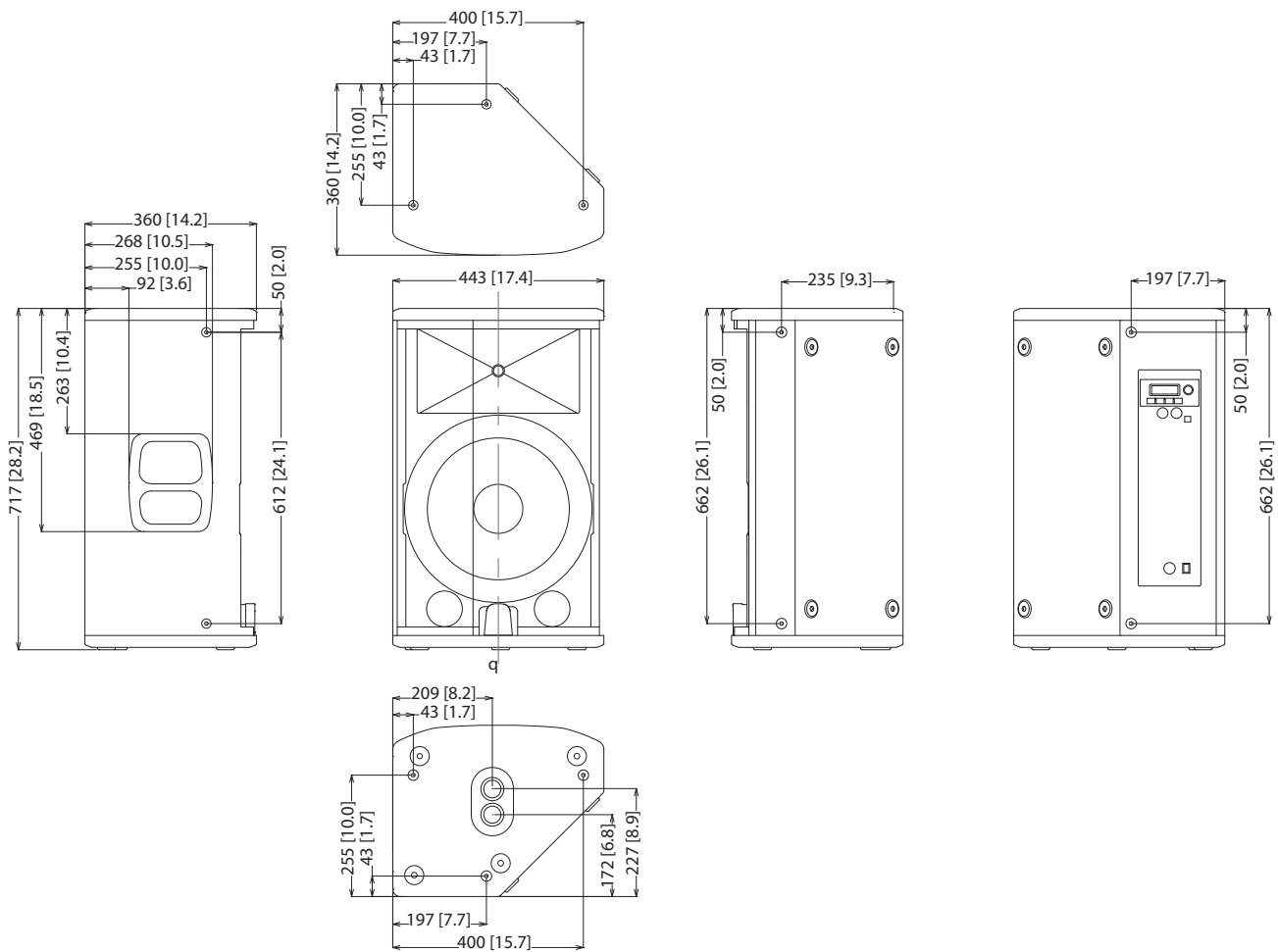

Portable

SIENA TSP152-AN

2500 Watt 2 Way 15" Powered Loudspeaker
with KLARK TEKNIK DSP Technology and
ULTRANET Networking

Dimensions

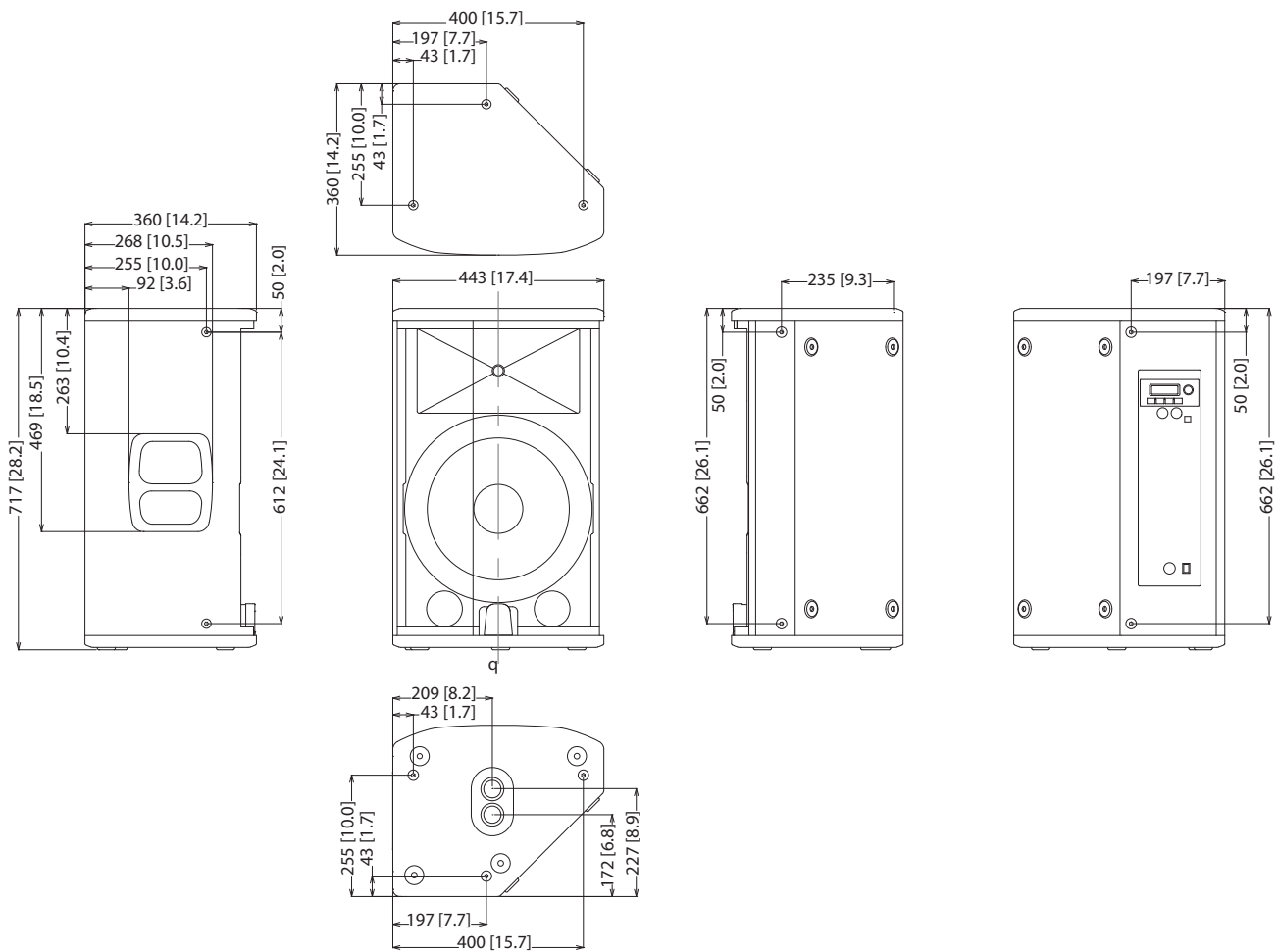

Portable

SIENA

TSP152-AN

2500 Watt 2 Way 15" Powered Loudspeaker
with KLARK TEKNIK DSP Technology and
ULTRANET Networking

Power Supply

| | |
|--------------------------|---------------------------------------|
| Power consumption | 90 W @ 1/8 max power |
| Voltage (fuses) | |
| USA / Canada | 120 V~, 60 Hz (T 15 A H 250 V) |
| UK / Australia / Europe | 220-240 V~, 50/60 Hz (T 10 A H 250 V) |
| Korea / China | 220-240 V~, 50/60 Hz (T 10 A H 250 V) |
| Japan | 100 V~, 50/60 Hz (T 15 A H 250 V) |

Enclosure

| | |
|------------------------|---|
| Dimensions HWD | 717 x 443 x 360 mm (28.2 x 17.4 x 14.2") |
| Net weight | 27 kg (61.2 lbs) |
| Construction | 18 mm (¾") birch plywood |
| Finish | Semi matt black paint |
| Grille | Powder coated perforated steel |
| Flying hardware | M10 x 6 points |

Accessories

TS-PC15-2 protective cover for TSP152

*Independent of limiters and driver protection circuits

†Only qualified personnel are allowed to modify the AC-Main cord and to adhere to all applicable national standards.

Portable

SIENA TSP152-AN

2500 Watt 2 Way 15" Powered Loudspeaker
with KLARK TEKNIK DSP Technology and
ULTRANET Networking



Portable

SIENA TSP152-AN

2500 Watt 2 Way 15" Powered Loudspeaker
with KLARK TEKNIK DSP Technology and
ULTRANET Networking



Portable

SIENA TSP152-AN

2500 Watt 2 Way 15" Powered Loudspeaker
with KLARK TEKNIK DSP Technology and
ULTRANET Networking



Portable

SIENA TSP152-AN

2500 Watt 2 Way 15" Powered Loudspeaker
with KLARK TEKNIK DSP Technology and
ULTRANET Networking



For service, support or more information contact the TURBOSOUND location nearest you:

Europe
MUSIC Tribe Brands UK Ltd.
Tel: +44156 273 2290
Email: CARECrea@music-group.com
CAREEnte@music-group.com
CARELife@music-group.com

USA/Canada
MUSIC Tribe Commercial NV Inc.
Tel: +1 702.800 8290
Email: CARECrea@music-group.com
CAREEnte@music-group.com
CARELife@music-group.com

Japan
MUSIC Tribe Services JP K.K.
Tel: +81 3 6231 0453
Email: CARECrea@music-group.com
CAREEnte@music-group.com
CARELife@music-group.com

MUSIC Tribe accepts no liability for any loss which may be suffered by any person who relies either wholly or in part upon any description, photograph, or statement contained herein. Technical specifications, appearances and other information are subject to change without notice. All trademarks are the property of their respective owners. MIDAS, KLARK TEKNIK, LAB GRUPPEN, LAKE, TANNÖY, TURBOSOUND, TC ELECTRONIC, TC HELICON, BEHRINGER, BUGERA and COOLAUDIO are trademarks or registered trademarks of MUSIC Tribe Global Brands Ltd. © MUSIC Tribe Global Brands Ltd. 2018 All rights reserved.