

# ULTRABASS

# BX4500H



## User's manual



Version 1.2 June 2006



[www.behringer.com](http://www.behringer.com) **JUST LISTEN.**

# ULTRABASS BX4500H

## IMPORTANT SAFETY INSTRUCTIONS



**CAUTION:** To reduce the risk of electric shock, do not remove the top cover (or the rear section). No user serviceable parts inside; refer servicing to qualified personnel.

**WARNING:** To reduce the risk of fire or electric shock, do not expose this appliance to rain and moisture. The apparatus shall not be exposed to dripping or splashing and no objects filled with liquids, such as vases, shall be placed on the apparatus.



This symbol, wherever it appears, alerts you to the presence of uninsulated dangerous voltage inside the enclosure—voltage that may be sufficient to constitute a risk of shock.



This symbol, wherever it appears, alerts you to important operating and maintenance instructions in the accompanying literature. Please read the manual.

## DETAILED SAFETY INSTRUCTIONS:

- 1) Read these instructions.
- 2) Keep these instructions.
- 3) Heed all warnings.
- 4) Follow all instructions.
- 5) Do not use this apparatus near water.
- 6) Clean only with dry cloth.
- 7) Do not block any ventilation openings. Install in accordance with the manufacturer's instructions.
- 8) Do not install near any heat sources such as radiators, heat registers, stoves, or other apparatus (including amplifiers) that produce heat.
- 9) Do not defeat the safety purpose of the polarized or grounding-type plug. A polarized plug has two blades with one wider than the other. A grounding type plug has two blades and a third grounding prong. The wide blade or the third prong are provided for your safety. If the provided plug does not fit into your outlet, consult an electrician for replacement of the obsolete outlet.
- 10) Protect the power cord from being walked on or pinched particularly at plugs, convenience receptacles, and the point where they exit from the apparatus.
- 11) Only use attachments/accessories specified by the manufacturer.
- 12) Use only with the cart, stand, tripod, bracket, or table specified by the manufacturer, or sold with the apparatus. When a cart is used, use caution when moving the cart/apparatus combination to avoid injury from tip-over.



13) Unplug this apparatus during lightning storms or when unused for long periods of time.

14) Refer all servicing to qualified service personnel. Servicing is required when the apparatus has been damaged in any way, such as power supply cord or plug is damaged, liquid has been spilled or objects have fallen into the apparatus, the apparatus has been exposed to rain or moisture, does not operate normally, or has been dropped.

15) **CAUTION** - These service instructions are for use by qualified service personnel only. To reduce the risk of electric shock do not perform any servicing other than that contained in the operation instructions unless you are qualified to do so.

# ULTRABASS

450-Watt Bass Amplifier Head with Shape Filter and Ultrabass Processor

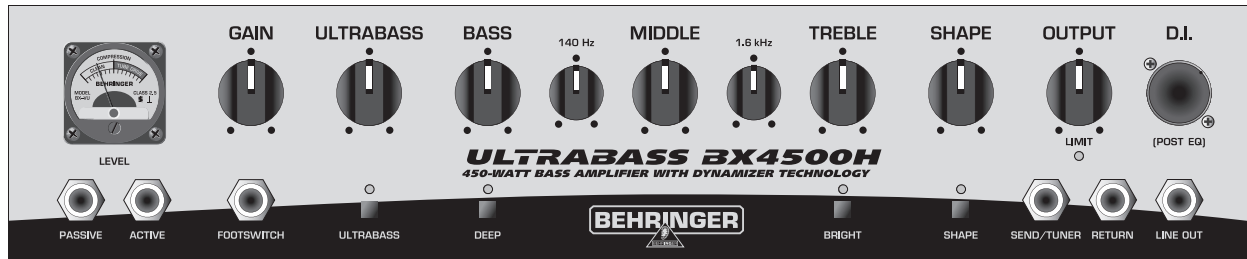

GB

- ▲ Extremely powerful 450-Watt bass amplifier head
- ▲ Patented\* Dynamizer technology for ultimate punch and to capture every nuance of your playing
- ▲ Switchable Ultrabass sub-harmonics processor for unbelievable low-end power
- ▲ Revolutionary Shape filter for extreme sound range
- ▲ Dedicated 5-band EQ with Bright and Deep functions for awesome sound shaping
- ▲ Musical opto-limiter for ultimate volume without distortion
- ▲ Vintage-style VU meter for precise signal level control
- ▲ Dual footswitch for Ultrabass and Shape functions included
- ▲ Balanced DI output for direct connection to your mixing console
- ▲ Dedicated Tuner Output/Effect Send and separate Line Output for additional flexibility
- ▲ FX Insert for external effects devices (stomp boxes, rack effects, etc.)
- ▲ 3 speaker outputs on 1/4" jack and professional speaker connectors (compatible with Neutrik® Speakon®)\*\*
- ▲ Integrated limiter and active, temperature-controlled cooling system for ultimate protection
- ▲ Ultra-rugged power supply with toroidal transformer for highest power reserves
- ▲ High-quality components and exceptionally rugged construction ensure long life
- ▲ Conceived and designed by BEHRINGER Germany

BX4500H

\* German Patent No.: 100 15 833

\*\* All Trademarks mentioned belong to their respective owners and are not affiliated with BEHRINGER®

# ULTRABASS BX4500H

## FOREWORD



Dear Customer,

Welcome to the team of ULTRABASS users and thank you very much for expressing your confidence in BEHRINGER products by purchasing the BEHRINGER BX4500H.

It is one of my most pleasant tasks to write this letter to you, because it is the culmination of many months of hard work delivered by our engineering team to reach a very ambitious goal: to present you with an outstanding bass workstation that gives

you maximum flexibility and performance with its unique sound character and broad range of functions.

The task to design the new ULTRABASS certainly meant a great deal of responsibility, which we assumed by focusing on you, the discerning user and musician. It also meant a lot of work and night shifts to accomplish this goal. But it was fun, too. Developing a product usually brings a lot of people together, and what a great feeling it is when everybody who participated in such a project can be proud of what we've achieved.

It is our philosophy to share our joy with you, because you are the most important member of the BEHRINGER team. With your highly competent suggestions for new products you've greatly contributed to shaping our company and making it successful. In return, we guarantee you uncompromising quality as well as excellent technical and audio properties at an extremely favorable price. All of this will enable you to fully unfold your creativity without being hampered by budget constraints.

We are often asked how we can produce such high-grade devices at such unbelievably low prices. The answer is quite simple: it's you, our customers! Many satisfied customers means large sales volumes enabling us to get better conditions of purchase for components, etc. Isn't it only fair to pass this benefit back to you? Because we know that your success is our success, too!

I would like to thank all people whose help on "Project ULTRABASS" has made it all possible. Everybody has made very personal contributions, starting from the designers of the unit to the many staff members in our company and finally to you, the users of BEHRINGER products.

My friends, it's been worth the trouble!

Thank you very much,

Uli Behringer

## TABLE OF CONTENTS

|  |           |
|--|-----------|
| <b>1. INTRODUCTION</b> .....   | <b>5</b>  |
| 1.1 The design concept .....   | 5         |
| 1.1.1 Patented Dynamizer technology .....  | 5         |
| 1.2 Before you get started .....   | 5         |
| 1.2.1 Shipment .....   | 5         |
| 1.2.2 Initial operation .....  | 5         |
| 1.2.3 Online registration .....  | 6         |
| <b>2. CONTROL ELEMENTS</b> .....   | <b>6</b>  |
| 2.1 Front panel .....  | 6         |
| 2.2 Rear panel .....   | 7         |
| <b>3. WIRING EXAMPLES</b> .....  | <b>7</b>  |
| 3.1 Standard setup comprising footswitch and <i>one</i> loudspeaker .....        | 7         |
| 3.2 Expanded setup with tuner and connection to a mixing console .....           | 8         |
| 3.3 Connecting <i>several</i> loudspeakers .....                                 | 8         |
| 3.3.1 Calculating the total impedance when connecting several loudspeakers ..... | 8         |
| 3.4 Connection of a multi-effects processor .....                                | 8         |
| 3.5 Setup for master/slave operation .....                                       | 8         |
| 3.5.1 ULTRABASS BX4500H as master .....  | 8         |
| 3.5.2 ULTRABASS BX4500H as slave controlled by an external amp/preamp .....      | 8         |
| <b>4. SHAPE FUNCTION</b> .....   | <b>9</b>  |
| <b>5. ULTRABASS FUNCTION</b> .....   | <b>9</b>  |
| <b>6. INSTALLATION</b> .....   | <b>9</b>  |
| 6.1 Mains connection .....   | 9         |
| 6.2 Audio connections .....  | 9         |
| 6.2.1 Loudspeaker connections .....  | 10        |
| <b>7. SPECIFICATIONS</b> .....   | <b>10</b> |
| <b>8. WARRANTY</b> .....   | <b>11</b> |

## WARNING!

☞ It should be pointed out that extreme output volumes may damage your hearing and/or your headphones. Turn down all LEVEL controls before you switch on the unit. Always set the volume at an appropriate level.

## 1. INTRODUCTION

Congratulations! With the BX4500H you have acquired a pro-level amplifier from our BX bass amplifier series. This revolutionary bass amplifier top has many of the features of our successful BX1200. Our top goal when designing the BX4500H was to set *new* standards. In fact, the BX4500H is a bass amp that gives you a full set of features plus a comprehensive range of connection and expansion options. With this amp you'll certainly rattle the planet!

BEHRINGER is an audio engineering company that has been successfully developing products for studio and live applications for many years now. Our range of products includes microphones and a variety of 19" devices (compressors, enhancers, noise gates, tube processors, headphone amps, digital effects devices, DI boxes, etc.) as well as monitoring and P.A. speakers plus professional live and recording consoles. You will find all of our technical know-how combined in your BX4500H.

Flexibility has become a particularly important factor in the music business over the past few years. Modern bass players need to offer a broad range of sounds, but should still be able to play in different kinds of applications at short notice: home recording, studio, live concerts. For this reason, it has always been our prime concern to give you a bass amplifier that offers a complete set of useful functions, but can still be operated intuitively and quickly.

Additionally, the world of electric bass playing has changed: new basses, with five or six strings, are being launched all the time, there are effects devices and the desire to create one's own "unique" sound—which can only be achieved with innovative amplifiers. Our unique ULTRABASS BX4500H gives you pioneering sounds and power galore.

We have expanded our BX Series with this amplifier top to give you all the freedom you need when expanding your set-up. No matter which speakers or cabinets you prefer—with its superb sound, your BX4500H will bring some life into your speaker.

As technology advances, you've got to keep track of the latest technological breakthroughs to avoid falling by the wayside. Which is what we did, by continuously improving this bass amplifier and including many of your valuable suggestions.

Experience a new-generation bass amp with fascinating features:

- ▲ Astounding sound diversity through SHAPE filter and ULTRABASS sub-harmonics processor.
- ▲ Unbelievable punch through innovative Dynamizer preamp technology.
- ▲ More gain, but no distortion through built-in limiter.
- ▲ Optimum level metering through clearly visible VU meter.
- ▲ A 5-band EQ with additional "Deep" and "Bright" functions meets all requirements in terms of tone-shaping.
- ▲ Plenty of power plus a built-in DI output—even on big stages you'll cut a fine figure with your BX4500H.

### 1.1 The design concept

This absolutely low-noise and indestructible bass amp represents the current state of the art.

The rugged enclosure of your ULTRABASS ensures that the unit will withstand rough handling on the road over many years.

### 1.1.1 Patented Dynamizer technology

When it comes to amplifying the signals delivered by electric instruments, you've got to separate the wheat from the chaff. Unlike mixed or mastered signals, electric instruments usually deliver extremely high signal peaks which, when raised in gain, produce nasty distortion. How an amplifier responds to these signal peaks can therefore be seen as one of its most essential quality features.

Many manufacturers use limiters preceding the power stage to limit dynamic signal peaks. However, the problem is the preamp, which is why we've equipped the BX4500H with our unique Dynamizer preamp circuitry that gives you a lively and punchy sound with signal peaks—even if the amp reaches its power limits. Extreme signal peaks are limited effectively while the average level and hence the power of the overall signal is raised. The sound gets more vivid and powerful in character, without any unmusical distortion. With its limiter in the power stage it is virtually impossible to overdrive the ULTRABASS BX4500H.

## 1.2 Before you get started

### 1.2.1 Shipment

Your BX4500H was carefully packed at the factory and the packaging is designed to protect the unit from rough handling. Nevertheless, we recommend that you carefully examine the packaging and its contents for any signs of physical damage that may have occurred during transit.

 **If the unit is damaged, please do not return it to BEHRINGER, but notify your dealer and the shipping company immediately, otherwise claims for damage or replacement may not be granted. Shipping claims must be made by the consignee.**

### 1.2.2 Initial operation

Be sure that there is enough space around the unit for cooling and please do not place the ULTRABASS on high temperature devices such as radiators etc. to avoid overheating.

 **Before you connect your ULTRABASS to the mains, please make sure that your local voltage matches the voltage required by the unit:**

The fuse holder on the female mains connector has 3 triangular markings, with two of these triangles opposing each other. The ULTRABASS is set to the operating voltage printed next to these markers and can be set to another voltage by turning the fuse holder by 180°. **CAUTION: This instruction does not apply to export models exclusively designed e.g. for 120 V operation!**

 **If you set the unit to a different mains voltage, be sure to use a fuse of the correct type and rating. Please refer to the "SPECIFICATIONS" for details.**

 **Blown fuses must be replaced by fuses of the same type and rating! Please refer to the "SPECIFICATIONS" for details.**

The mains connection of the BX4500H is made by using the enclosed mains cable and a standard IEC receptacle. It meets all of the international safety certification requirements.

 **Please make sure that all units have a proper ground connection. For your own safety, never remove or disable the ground conductor from the unit or of the AC power cord.**

# ULTRABASS BX4500H

## 1.2.3 Online registration

Please do remember to register your new BEHRINGER equipment right after your purchase by visiting [www.behringer.com](http://www.behringer.com) (alternatively [www.behringer.de](http://www.behringer.de)) and kindly read the terms and conditions of our warranty carefully.

Should your BEHRINGER product malfunction, our goal is to have it repaired as quickly as possible. To arrange for warranty service, please contact the retailer from whom the equipment was purchased. Should your BEHRINGER dealer not be located in your vicinity, you may directly contact one of our subsidiaries. Corresponding contact information is included in the original equipment packaging (Global Contact Information/European Contact Information). Should your country not be listed, please contact the distributor nearest you. A list of distributors can be found in the support area of our website ([www.behringer.com](http://www.behringer.com)).

Registering your purchase and equipment with us helps us process your repair claims quicker and more efficiently.

Thank you for your cooperation!

## 2. CONTROL ELEMENTS

### 2.1 Front panel

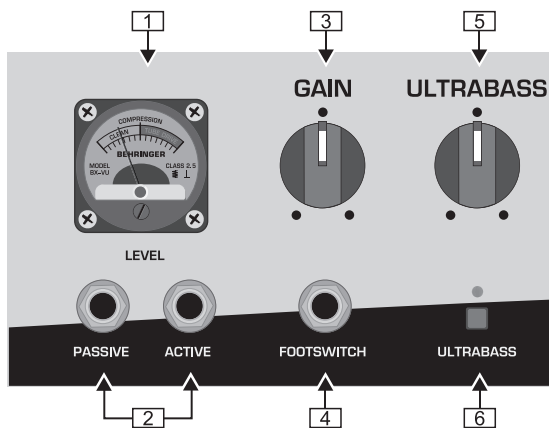

Fig. 2.1: BX4500H front panel (section 1)

- 1 The LEVEL VU meter reads the level that is applied to the preamp circuitry of the BX4500H.
- ☞ If the GAIN control 3 is set fully counterclockwise, the VU meter reads the input level only. Selecting "Active" 2 instead of "Passive" is recommended if the input level appears too high (in the right-hand third of the VU meter). Use the GAIN control to set the amplifier properly (so that the meter is in the mid region). The overall volume can be adjusted with the OUTPUT control 16.
- 2 These are the inputs for your electric bass guitar. The PASSIVE jack is for passive basses, the ACTIVE jack for active instruments with high output levels. The ACTIVE jack features 10 dB less gain.
- 3 Use the GAIN control to determine the input gain on your BX4500H.
- 4 Connect your footswitch to the FOOTSWITCH jack, so as to control the sub-harmonics processor and SHAPE filter.
- 5 With the sub-harmonics processor switched on (see 6) you can add ultra-low bass frequencies to your sound by turning the ULTRABASS control (see chapter 5).
- 6 Press the ULTRABASS switch to enable the sub-harmonics processor: The LED above the switch lights up.

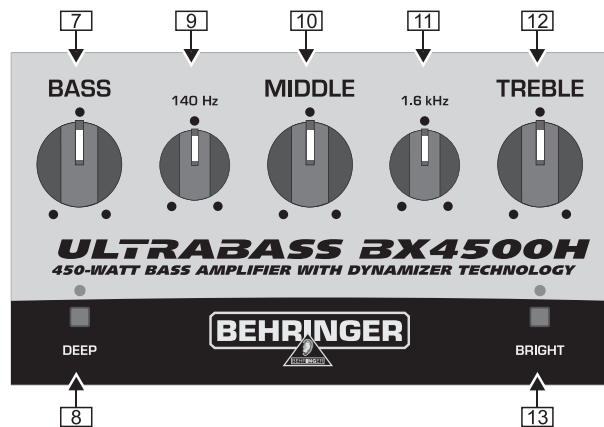

Fig. 2.2: BX4500H front panel (section 2)

- 7 The BASS control in the EQ section allows you to boost or cut the bass frequencies at approx. 50 Hz.
- 8 Press the DEEP switch to add low frequencies (ranging from 30 - 200 Hz) to your bass sound. When the DEEP function is switched on, the LED above the switch lights up.
- 9 This control governs the upper bass-frequency range at approx. 140 Hz.
- 10 The MIDDLE control allows you to boost/cut the low midrange frequencies at approx. 500 Hz.
- 11 This control raises/lowers the high midrange frequencies at approx. 1.6 kHz.
- 12 The TREBLE control governs the high-frequency range on your BX4500H at approx. 7.5 kHz.
- 13 Use this switch to enable/disable the BRIGHT effect, which adds some brilliance to the treble frequencies in the range from 2 - 20 kHz. When the BRIGHT function is on, its respective LED lights up.

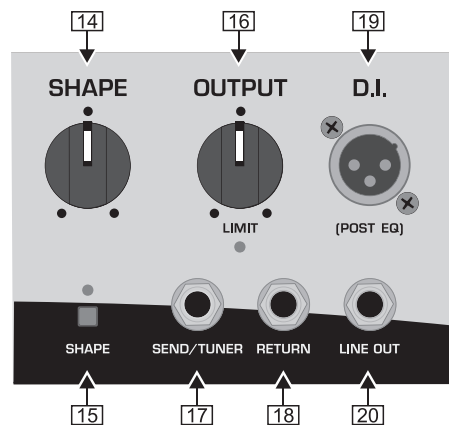

Fig. 2.3: BX4500H front panel (section 3)

- 14 When you enable the SHAPE filter with switch 15, you can use the SHAPE control to modify the filter sound. The filter position is adjustable in the range from 120 Hz - 1.2 kHz.
- 15 The SHAPE switch activates the SHAPE filter. When the filter is on, the LED above the switch lights up.
- 16 Use the OUTPUT control to determine the overall volume of your BX4500H.
- ☞ When the built-in limiter is activated, the LED below the OUTPUT control lights up.

- [17] Connect the *SEND/TUNER* output to the input of your effects device, for example, our proven multi-effects processor BEHRINGER VIRTUALIZER PRO DSP2024P. This output can also be used to connect your tuner.
- [18] Connect the *RETURN* jack to the output of your effects device. Since the BX4500H features a serial effects path, the mix ratio must be set on your effects device.
- [19] Use the balanced *D.I.* XLR output to feed the audio signal from your ULTRABASS to an external mixing console. The D.I. signal is wired post-EQ.
- [20] Use the *LINE OUT* jack to connect your BX4500H to a mixing console that has no balanced inputs and/or to provide a signal that is independent of all settings adjusted on the BX4500H.

The **LINE OUT** output is wired post effects loop [17] & [18] and can also be used to feed the output signal of your BX4500H to an external bass amp.

## 2.2 Rear panel

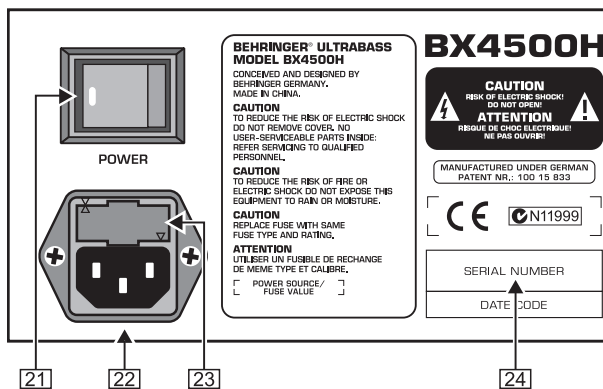

Fig. 2.4: BX4500H rear panel (section 1)

- [21] Use the *POWER* switch to switch the BX4500H on or off. You should always make sure that the *POWER* switch is in the "Off" position when initially connecting the unit to the mains.

To disconnect the unit from the mains, pull out the main cord plug. When installing the product, ensure that the plug is easily accessible. If mounting in a rack, ensure that the mains can be easily disconnected by a plug or by an all-pole disconnect switch on or near the rack.

**Please note: Merely switching the unit off does not mean that it is fully disconnected from the mains. When not using the unit for prolonged periods of time, please unplug the unit's power cord from the power outlet.**

- [22] **MAINS CONNECTION.** Use the power cord supplied with the unit to connect it to the mains.
- [23] **FUSE HOLDER/VOLTAGE SELECTOR.** Before connecting the unit to the mains, make sure that the voltage setting matches your local voltage. A blown fuse should only be replaced by a fuse of the same type and rating. On some units, the fuse holder can be switched to one of two positions, i.e. 230 V and 120 V. When operating the unit outside Europe at 120 V, a higher fuse rating is required.
- [24] **SERIAL NUMBER.**

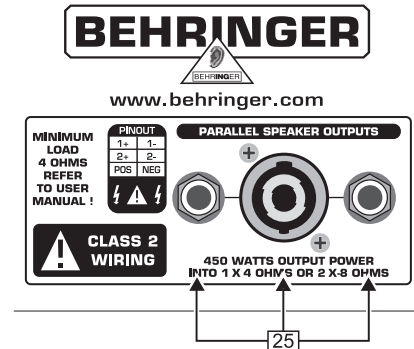

Fig. 2.5: BX4500H rear panel (section 2)

- [25] Use the *SPEAKER* outputs to connect your loudspeakers. The outputs are wired in parallel on two 1/4" jacks and a professional loudspeaker connector (compatible to Neutrik® Speakon®).

Your speaker cabinets should have a sufficient power rating (>450 W) and preferably a total impedance of 4 Ω to avoid speaker damage. Too high a load impedance will decrease the output power rating of the power stage!

For correct speaker connection please also refer to chapters 3.3, 3.3.1 and 6.2.1!

## 3. WIRING EXAMPLES

This chapter is aimed at describing and illustrating basic wiring examples.

### 3.1 Standard setup comprising footswitch and one loudspeaker

The standard setup is intended for rehearsals, sessions and club gigs.

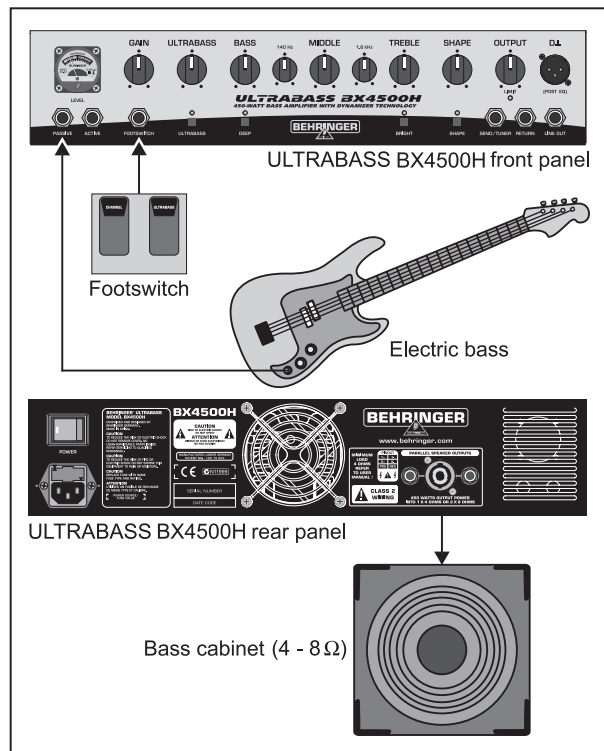

Fig. 3.1: Standard setup

# ULTRABASS BX4500H

## 3.2 Expanded setup with tuner and connection to a mixing console

The wiring scheme shown here builds on the standard setup.

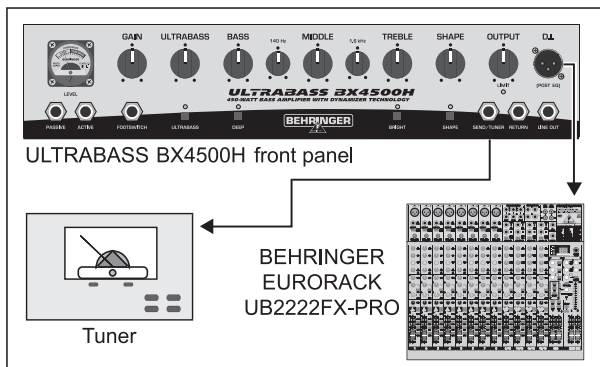

Fig. 3.2: Expanded setup

The output signal of your BX4500H can be taken directly at the XLR D.I. output and fed to a microphone input of your mixing console using a balanced microphone cable. Please ensure that phantom power is switched off on the respective channel of your mixer!

The D.I. output signal of your BX4500H is independent of the OUTPUT control's setting. However, it depends on all remaining settings and the effects loop.

If you own a tuner that is able to loop through and mute the signal, we recommend connecting it to the effects loop [17] and [18]. This allows you to mute the output signal as long as you tune your instrument.

## 3.3 Connecting several loudspeakers

Needless to say, you can connect several loudspeakers (three at the most) to the speaker outputs of your BX4500H, which are wired in parallel. The figure below illustrates an example for such a connection.

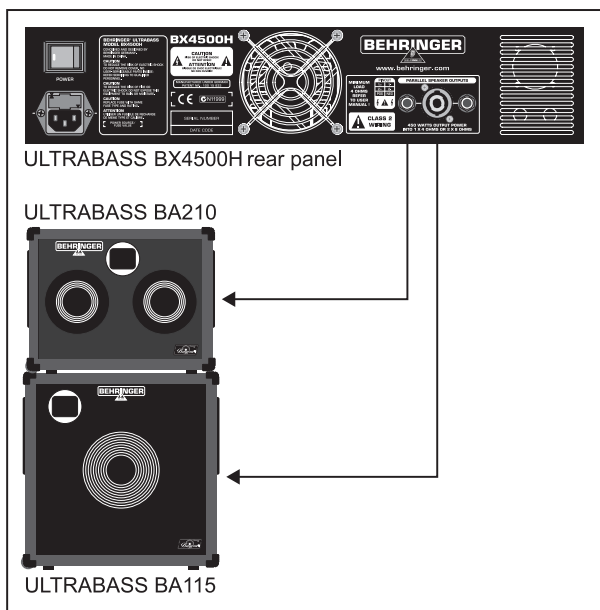

Fig. 3.3: Connection of two speaker cabinets

If several speakers are used in parallel, the total impedance should not drop below 4 Ω!

## 3.3.1 Calculating the total impedance when connecting several loudspeakers

If several speakers are used in parallel, their total impedance can be calculated as follows:

$$Z = \frac{1}{1/Z_1 + 1/Z_2 + \dots}$$

E.g. this would allow two 8 Ω loudspeakers ...

$$\frac{1}{1/8 \Omega + 1/8 \Omega} = 4 \Omega$$

... or 1 x 8 Ω and 2 x 16 Ω:

$$\frac{1}{1/8 \Omega + 1/16 \Omega + 1/16 \Omega} = 4 \Omega$$

Please note that varying loudspeaker impedances result in different output power delivered to the individual speaker cabinets.

## 3.4 Connection of a multi-effects processor

Use the SEND/TUNER jack to connect the bass signal to a multi-effects device or a compressor. The output level is independent on the position of the OUTPUT control.

The RETURN jack should be connected to the output of your effects device. If this jack is used for connection, the direct signal is interrupted automatically. The ratio between direct and effects signal has to be set on your effects device.



Fig. 3.4: Connection of a multi-effects processor

## 3.5 Setup for master/slave operation

### 3.5.1 ULTRABASS BX4500H as master

The LINE OUT jack allows you to connect the BX4500H to an external power amp, using a commercial instrument cable equipped with mono phone plugs. The signal present here is independent on the position of the OUTPUT control.

### 3.5.2 ULTRABASS BX4500H as slave controlled by an external amp/preamp

To use the power amp of your ULTRABASS for an external amp or preamp, you need to connect the line output of the external amplifier to the RETURN jack on your BX4500H. The connected signal can be taken at the D.I. output. Use the OUTPUT control to set the volume level.



## 4. SHAPE FUNCTION

The SHAPE function on your BX4500H provides a revolutionary type of filter that you can use to modify your bass sound in full detail. The filter allows you to shape your sound—which is a must for bass players today. Extreme filter settings will give your bass sound more power, for example:

You want to play a live bass solo but the sound doesn't cut through. The solo should stand out, rather than being drowned. Set up a solid basic sound plus a very distinctive solo sound using the SHAPE filter. Connect your footswitch to control the SHAPE filter.

The SHAPE filter is a bargain when you are using two different bass guitars. Maybe you want to change from a jazz bass to a fretless bass, and vice versa—two instruments with a completely different sound. During gigs you often lack the time to set up your amp for a different instrument, so you'll be happy to have a BX4500H, because you can use the SHAPE filter for your fretless sound, and the basic sound for the jazz bass.

## 5. ULTRABASS FUNCTION

Extremely low bass sounds playing one octave below the lowest available bass guitar frequency are quite trendy in current music productions. Often, you can do this in studios only, because most bass amplifiers have no sub-harmonics function. Not so with your BX4500H: the ULTRABASS processor gives you the ultimate tool to shape up-to-date sounds.

You'll be surprised how deep your bass can sound with the ULTRABASS function of your BX4500H. Extreme settings can be particularly interesting if you want to give your sound some flavor in the treble range. By the way: when you use the SHAPE filter set to a low cut-off frequency (which is a nice setting for growling sounds), but feel that there's not enough power in the bass range, the sub-harmonics processor will be there to help you: even though the sound is still growling, now it has much more depth.

The ULTRABASS function can easily be switched on and off via the supplied footswitch. This allows you to fine-tune certain passages only.

## 6. INSTALLATION

### 6.1 Mains connection

The mains connection is made by using the enclosed mains cable and a standard IEC receptacle. It meets all of the international safety certification requirements.

**Please make sure that all units have a proper ground connection. For your own safety, never remove or disable the ground conductor of the unit or of the AC power cable.**

### 6.2 Audio connections

The BEHRINGER ULTRABASS is equipped with mono phone jacks, except for the D.I. output which is on a balanced XLR connector. The speaker jacks are on 1/4" TS and professional speaker connectors (compatible to Neutrik® Speakon®).

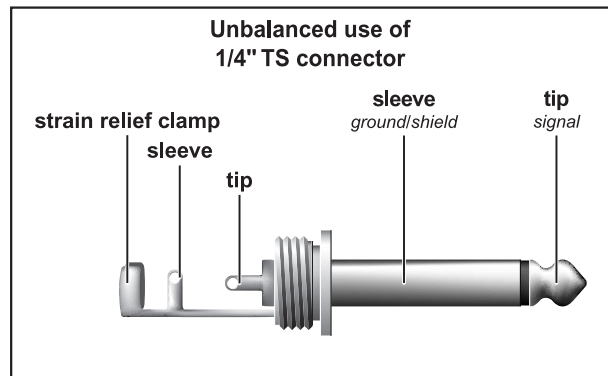

Fig. 6.1: 1/4" TS connector

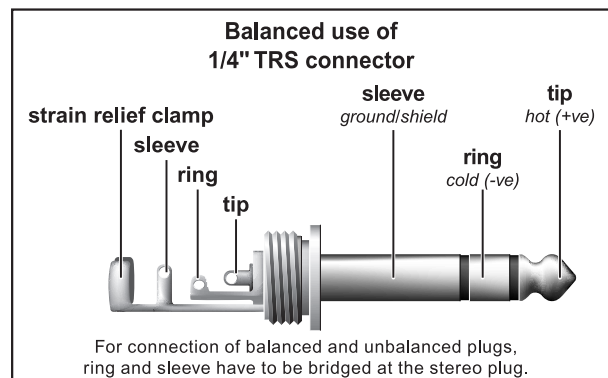

Fig. 6.2: 1/4" TRS connector

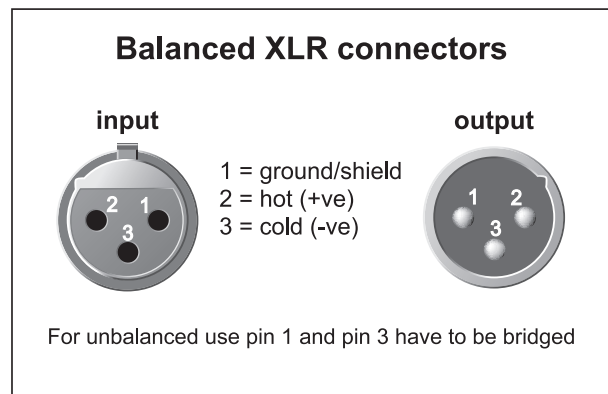



Fig. 6.3: XLR connectors

# ULTRABASS BX4500H

 Please ensure that only qualified personnel install and operate the BX4500H. During installation and operation the user must have sufficient electrical contact to earth. Electrostatic charges might affect the operation of the unit.

## 6.2.1 Loudspeaker connections

In total, your BX4500H features three loudspeaker connectors.

 **When connecting loudspeakers to the 1/4" jack connectors, please switch off the device first. Power up the unit again after all connections have been made.**

Please use a speaker compatible to Neutrik® Speakon® if you want to connect one speaker cabinet only. For optimum output power delivered to the speaker(s), use your BX4500H in combination with one 4 Ω or two 8 Ω cabinets.

Your BX4500H is equipped with high-quality connectors compatible to Neutrik® Speakon®, which ensure safe and trouble-free operation. These connectors were especially developed for high-power loudspeakers. Once it is plugged in, it safely locks into its position and cannot be accidentally disengaged. It prevents the occurrence of electrical shock and ensures the correct polarity.

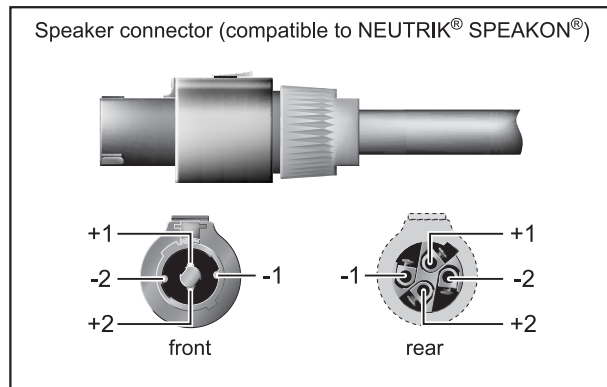

Fig. 6.4: Professional connector compatible to Neutrik® Speakon®

## 7. SPECIFICATIONS

### AUDIO INPUTS

|                          |                            |
|--------------------------|----------------------------|
| Active instrument input  | 1/4" mono jack, unbalanced |
| Input impedance          | approx. 220 kΩ unbalanced  |
| Passive instrument input | 1/4" mono jack, unbalanced |
| Input impedance          | approx. 750 kΩ unbalanced  |
| Return                   | 1/4" mono jack, unbalanced |
| Input impedance          | approx. 10 kΩ unbalanced   |

### AUDIO OUTPUTS

|                        |                                   |
|------------------------|-----------------------------------|
| Send/Tuner             | 1/4" mono jack, unbalanced        |
| Output impedance       | min. 2.2 kΩ unbalanced            |
| Line Out               | 1/4" mono jack, unbalanced        |
| Output impedance       | approx. 100 Ω unbalanced          |
| Output level           | max. +4 dBu                       |
| D.I. output            | XLR connector, servo-balanced     |
| Output impedance       | approx. 100 Ω balanced            |
| Output level           | max. -10 dBu                      |
| Loudspeaker connectors | 1/4" mono jack, unbalanced        |
|                        | professional connector            |
|                        | (compatible to Neutrik® Speakon®) |
| Load impedance         | min. 4 Ω                          |

### SYSTEM SPECIFICATIONS

|                  |                    |
|------------------|--------------------|
| Power amp output | 450 Watts into 4 Ω |
|------------------|--------------------|

### POWER SUPPLY

|                  |                               |
|------------------|-------------------------------|
| Mains voltages   | U.S./Canada                   |
|                  | 120 V~, 60 Hz, 6 A            |
|                  | China/Korea                   |
|                  | 220 V~, 50 Hz, 3 A            |
|                  | Europe/U.K./Australia         |
|                  | 230 V~, 50 Hz, 3 A            |
|                  | Japan                         |
|                  | 100 V~, 50/60 Hz, 6 A         |
|                  | General export model          |
|                  | 120/230 V~, 50 - 60 Hz        |
| Fuse             | 100 - 120 V~: T 10 A H 250 V  |
|                  | 200 - 240 V~: T 6.3 A H 250 V |
| Mains connection | Standard IEC receptacle       |

### PHYSICAL/WEIGHT

|                        |                            |
|------------------------|----------------------------|
| Dimensions (H x W x D) | approx. 5 3/4" (144,6 mm)  |
|                        | x 19 1/8" (486 mm)         |
|                        | x 12" (305 mm)             |
| Weight                 | approx. 14 kg (30 7/8 lbs) |

BEHRINGER constantly strives to maintain the highest quality standards. Modifications may be made, if necessary, without prior notice. The specifications and appearance of the equipment may therefore differ from those listed or illustrated.

## 8. WARRANTY

### § 1 OTHER WARRANTY RIGHTS AND NATIONAL LAW

1. This warranty does not exclude or limit the buyer's statutory rights provided by national law, in particular, any such rights against the seller that arise from a legally effective purchase contract.

2. The warranty regulations mentioned herein are applicable unless they constitute an infringement of national warranty law.

### § 2 ONLINE REGISTRATION

Please do remember to register your new BEHRINGER equipment right after your purchase by visiting [www.behringer.com](http://www.behringer.com) (alternatively [www.behringer.de](http://www.behringer.de)) and kindly read the terms and conditions of our warranty carefully.

Registering your purchase and equipment with us helps us process your repair claims quicker and more efficiently.

Thank you for your cooperation!

### § 3 WARRANTY

1. BEHRINGER (BEHRINGER International GmbH including all BEHRINGER subsidiaries listed on the enclosed page, except BEHRINGER Japan) warrants the mechanical and electronic components of this product to be free of defects in material and workmanship for a period of one (1) year\* from the original date of purchase, in accordance with the warranty regulations described below. If the product shows any defects within the specified warranty period that are not excluded from this warranty as described under § 5, BEHRINGER shall, at its discretion, either replace or repair the product using suitable new or reconditioned parts. In the case that other parts are used which constitute an improvement, BEHRINGER may, at its discretion, charge the customer for the additional cost of these parts.

2. If the warranty claim proves to be justified, the product will be returned to the user freight prepaid.

3. Warranty claims other than those indicated above are expressly excluded.

### § 4 RETURN AUTHORIZATION NUMBER

1. To obtain warranty service, the buyer (or his authorized dealer) must call BEHRINGER (see enclosed list) during normal business hours **BEFORE** returning the product. All inquiries must be accompanied by a description of the problem. BEHRINGER will then issue a return authorization number.

2. Subsequently, the product must be returned in its original shipping carton, together with the return authorization number to the address indicated by BEHRINGER.

3. Shipments without freight prepaid will not be accepted.

### § 5 WARRANTY REGULATIONS

1. Warranty services will be furnished only if the product is accompanied by a copy of the original retail dealer's invoice. Any product deemed eligible for repair or replacement under the terms of this warranty will be repaired or replaced.

2. If the product needs to be modified or adapted in order to comply with applicable technical or safety standards on a national or local level, in any country which is not the country for which the product was originally developed and manufactured, this modification/adaptation shall not be considered a defect in materials or workmanship. The warranty does not cover any such modification/adaptation, irrespective of whether it was carried out properly or not. Under the terms of this warranty, BEHRINGER shall not be held responsible for any cost resulting from such a modification/adaptation.

3. Free inspections and maintenance/repair work are expressly excluded from this warranty, in particular, if caused by improper handling of the product by the user. This also applies to defects caused by normal wear and tear, in particular, of faders, crossfaders, potentiometers, keys/buttons, tubes, guitar strings, illuminants and similar parts.

4. Damages/defects caused by the following conditions are not covered by this warranty:

- ▲ improper handling, neglect or failure to operate the unit in compliance with the instructions given in BEHRINGER user or service manuals.
- ▲ connection or operation of the unit in any way that does not comply with the technical or safety regulations applicable in the country where the product is used.
- ▲ damages/defects caused by force majeure or any other condition that is beyond the control of BEHRINGER.

5. Any repair or opening of the unit carried out by unauthorized personnel (user included) will void the warranty.

6. If an inspection of the product by BEHRINGER shows that the defect in question is not covered by the warranty, the inspection costs are payable by the customer.

7. Products which do not meet the terms of this warranty will be repaired exclusively at the buyer's expense. BEHRINGER will inform the buyer of any such circumstance. If the buyer fails to submit a written repair order within 6 weeks after notification, BEHRINGER will return the unit C.O.D. with a separate invoice for freight and packing. Such costs will also be invoiced separately when the buyer has sent in a written repair order.

### § 6 WARRANTY TRANSFERABILITY

This warranty is extended exclusively to the original buyer (customer of retail dealer) and is not transferable to anyone who may subsequently purchase this product. No other person (retail dealer, etc.) shall be entitled to give any warranty promise on behalf of BEHRINGER.

### § 7 CLAIM FOR DAMAGES

Failure of BEHRINGER to provide proper warranty service shall not entitle the buyer to claim (consequential) damages. In no event shall the liability of BEHRINGER exceed the invoiced value of the product.

\* Customers in the European Union please contact BEHRINGER Germany Support for further details.

Technical specifications and appearance subject to change without notice. The information contained herein is correct at the time of printing. The names of companies, institutions or publications pictured or mentioned and their respective logos are registered trademarks of their respective owners. Their use neither constitutes a claim of the trademarks by BEHRINGER nor affiliation of the trademark owners with BEHRINGER. BEHRINGER accepts no liability for any loss which may be suffered by any person who relies either wholly or in part upon any description, photograph or statement contained herein. Colours and specification may vary slightly from product. Products are sold through our authorised dealers only. Distributors and dealers are not agents of BEHRINGER and have absolutely no authority to bind BEHRINGER by any express or implied undertaking or representation. No part of this manual may be reproduced or transmitted in any form or by any means, electronic or mechanical, including photocopying and recording of any kind, for any purpose, without the express written permission of BEHRINGER International GmbH. BEHRINGER® is a registered trademark.

ALL RIGHTS RESERVED. © 2006 BEHRINGER International GmbH,  
Hanns-Martin-Schleyer-Str. 36-38, 47877 Willich-Münchheide II, Germany.  
Tel. +49 2154 9206 0, Fax +49 2154 9206 4903