

## Install

# IMPACT TCI52-TR

2 Way 5" Full Range Loudspeaker with  
Line Transformer for Installation Applications  
(Weather Resistant)

- Compact 2 way full range surface-mount loudspeaker for installation applications
- 60 Watts continuous, 240 Watts peak power
- High excursion 5" low frequency driver with high temperature voice coil
- 1" ferrofluid cooled neodymium high frequency driver
- Multiple transformer taps for 70 V and 100 V line systems or 16 Ohm direct input
- Weather resistant plated perforated grille with powder coating for outdoor use
- Proprietary elliptical waveguide provides wide 100° H x 70° V dispersion
- Wall-mount bracket with integral loudspeaker connections included
- Architecturally styled glass filled impact resistant enclosure
- Semi matt black finish fits unobtrusively in any environment
- 2 x M6 rigging points compatible with TURBOSOUND and OmniMount\* brackets
- 3/8" mic stand fitting for spot monitor applications
- 10-Year Warranty Program\*
- Designed and engineered in the U.K.

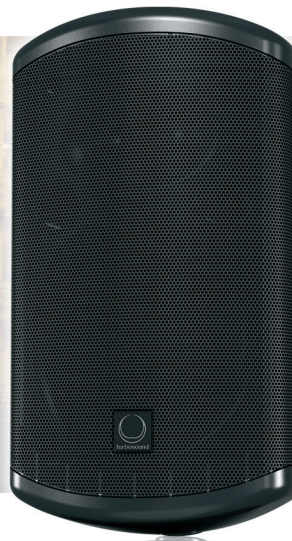

The ultra-compact IMPACT TCI52-TR is an indoor/outdoor passive two way surface-mount loudspeaker that is ideally suited for a wide range of installed speech and music applications. With a power handling capacity of 240 Watts, the weather-resistant system consists of a high excursion 5" low frequency driver with a high temperature voice coil, and a 1" neodymium ferro-fluid cooled high frequency driver mated to a proprietary elliptical waveguide – for a wide 100° horizontal by 70° vertical dispersion pattern.



## Custom-Engineered Drivers

TURBOSOUND is recognised the world over for designing and building some of the most iconic loudspeakers and subwoofers in the industry. We take meticulous care and pride in maintaining that reputation by utilising only drivers designed specifically for each application – it's what sets us apart from the competition. The custom designed high excursion 5" low frequency and 1" neodymium high frequency drivers ensure truly world-class performance that will deftly stand the test of time.

## Install

# IMPACT TCI52-TR

2 Way 5" Full Range Loudspeaker with  
Line Transformer for Installation Applications  
(Weather Resistant)

### Internal Transformer

The TCI52-TR includes an internal line transformer with multiple taps for use in 70 and 100 Volt line distributed sound applications, as well as a direct 16 Ohm input for use with low-impedance amplifiers. Taps are provided at 60, 30, and 15 Watts on the 100 V line; 60, 30, 15, and 7.5 Watts on the 70 V line.

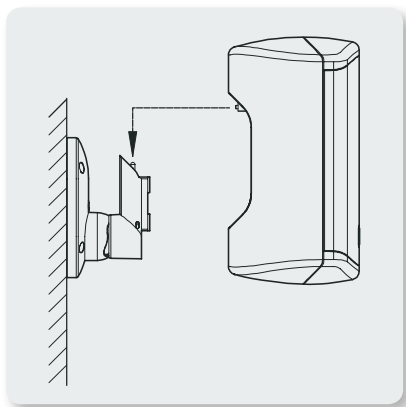

### Installation and Connectivity

The TCI52-TR is supplied with an adjustable wall mounting bracket that also provides the loudspeaker connections, allowing the brackets alone to be sited, installed, and wired in the early stages of building construction or remodeling – making final installation a greatly simplified and cost effective process. Threaded internal M6 rigging points are also provided for installation with [TURBOSOUND](#) wall and ceiling hardware, as well as industry standard brackets. A convenient  $\frac{3}{8}$ " mic stand fitting, hidden under the EPDM rubber cover on the bottom of the cabinet, allows affixing the TCI52-TR to a standard microphone stand for use as a 'spot monitor'.

### Designed to Weather the Elements

When permanently installed, the architecturally styled, glass filled and impact resistant TCI52-TR enclosure sports a classic semi matt black finish, which allows it to fit unobtrusively and elegantly into any environment. The included integral wall mounting bracket provides hidden cable management, completing the seamless visual presentation. The weatherised paint, zinc plated grill with outdoor powdercoat, and weather resistant coated drivers deliver an IP34 rated package that not only provides class-leading performance, but maintains its attractive appearance for many years.



Install

# IMPACT TCI52-TR

2 Way 5" Full Range Loudspeaker with  
Line Transformer for Installation Applications  
(Weather Resistant)



## You Are Covered

We always strive to provide the best possible Customer Experience. Our products are made in our own [MUSIC Tribe](#) factory using state-of-the-art automation, enhanced production workflows and quality assurance labs with the most sophisticated test equipment available in the world. As a result, we have one of the lowest product failure rates in the industry, and we confidently back it up with a generous [Warranty program](#).

Install

# IMPACT TCI52-TR

2 Way 5" Full Range Loudspeaker with  
Line Transformer for Installation Applications  
(Weather Resistant)

## Frequency Response Sensitivity 1 W / 1 m

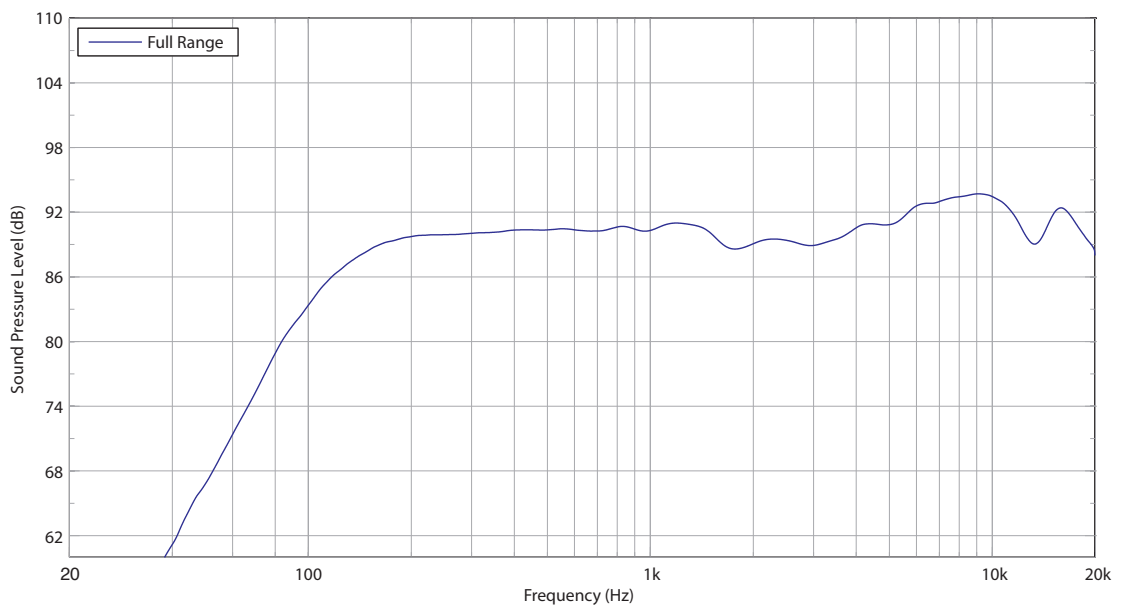

## Impedance

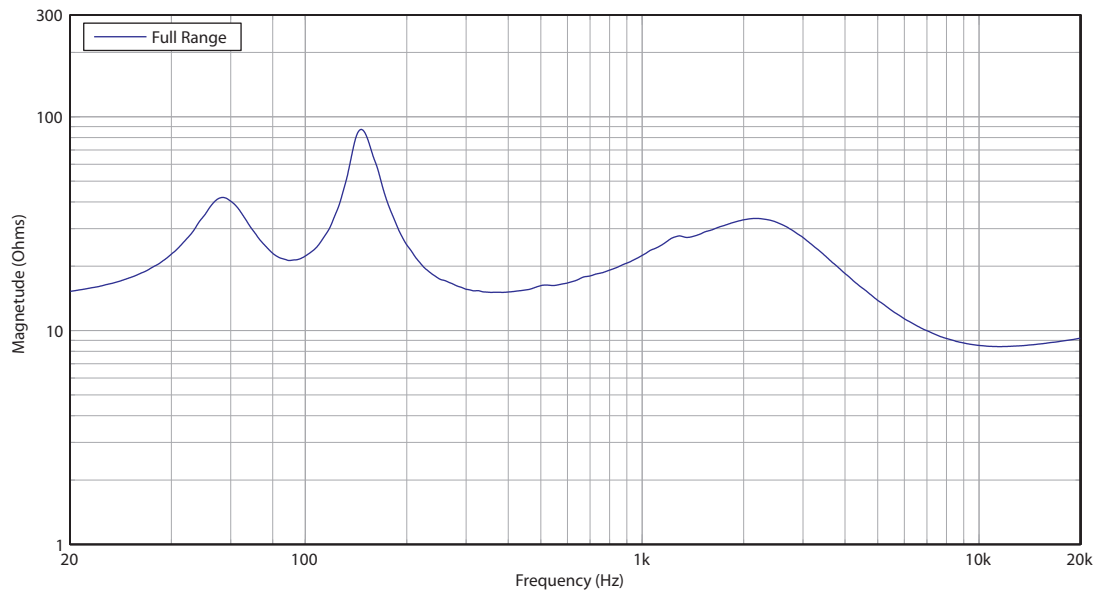

Install

# IMPACT TCI52-TR

2 Way 5" Full Range Loudspeaker with  
Line Transformer for Installation Applications  
(Weather Resistant)

## Horizontal Beamwidth

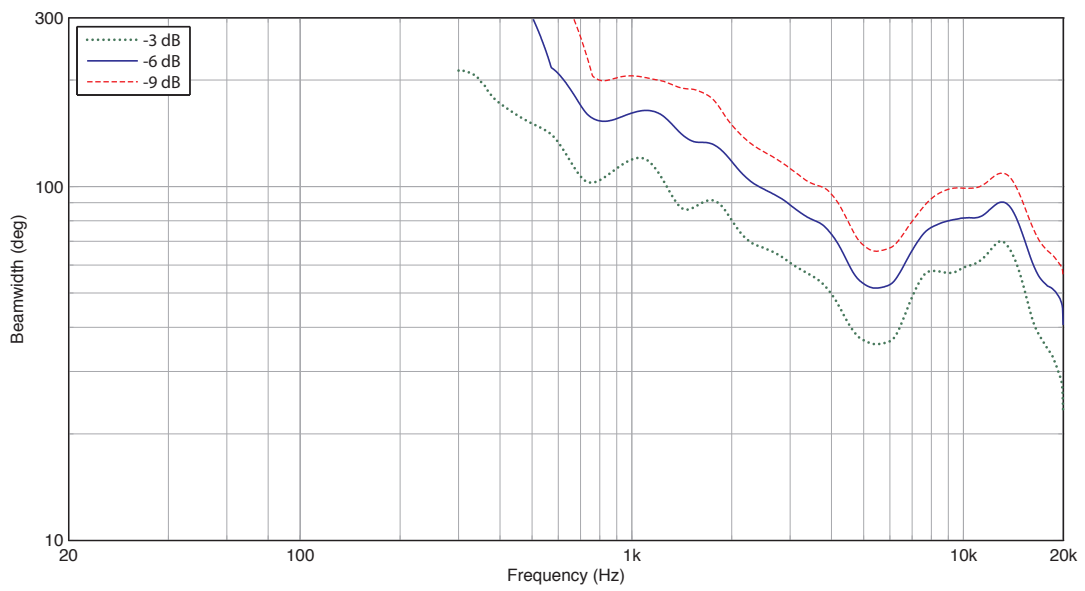

## Vertical Beamwidth

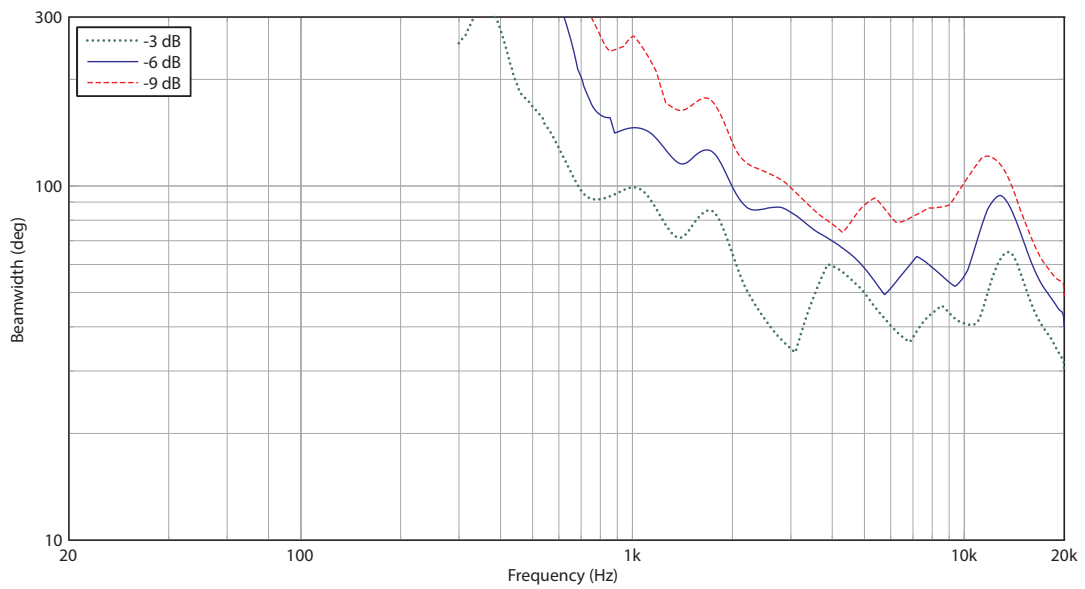

Install

# IMPACT TCI52-TR

2 Way 5" Full Range Loudspeaker with  
Line Transformer for Installation Applications  
(Weather Resistant)

## Horizontal Polar Plots

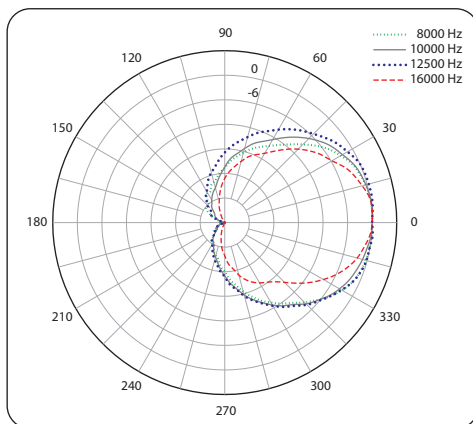
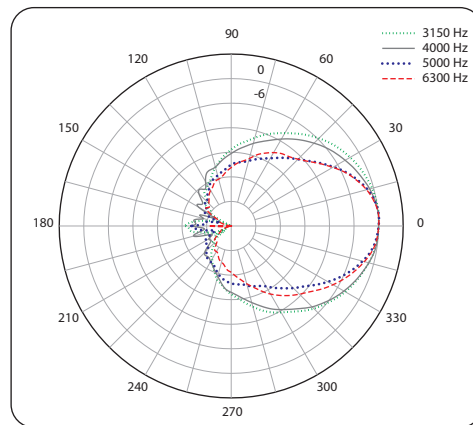
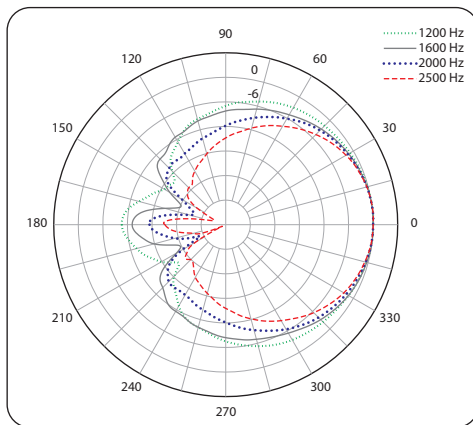
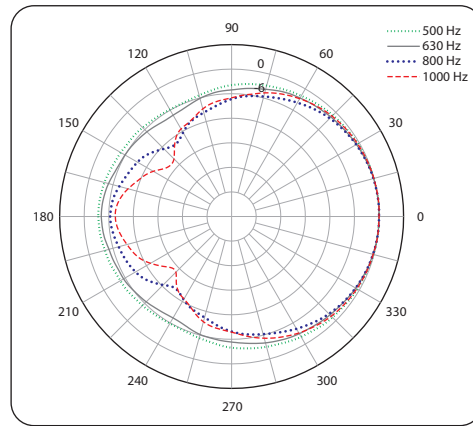
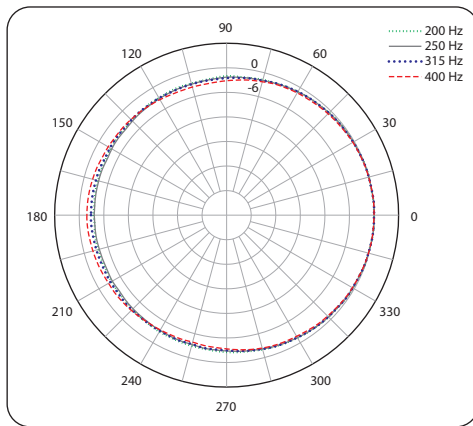

Install

# IMPACT TCI52-TR

2 Way 5" Full Range Loudspeaker with  
Line Transformer for Installation Applications  
(Weather Resistant)

## Vertical Polar Plots

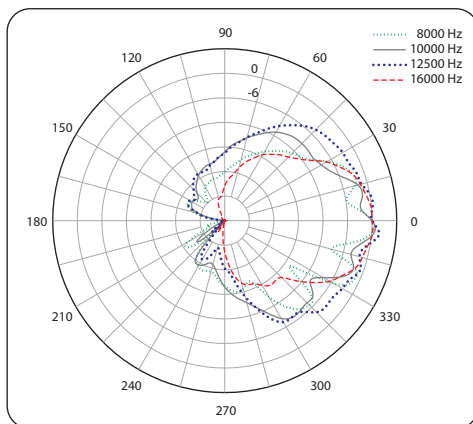
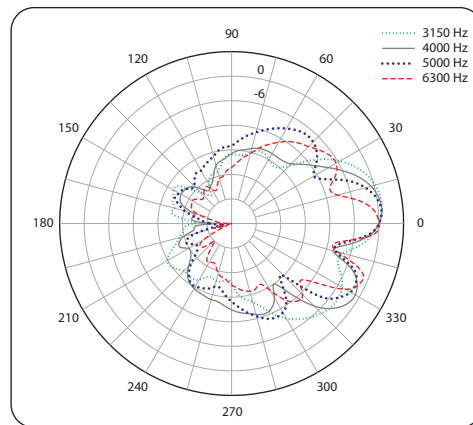
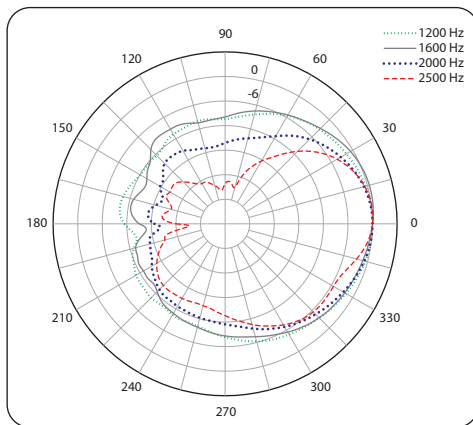
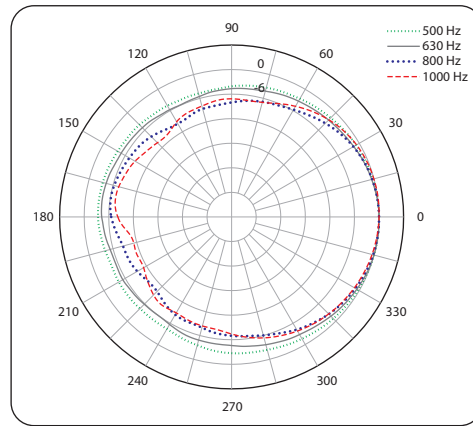
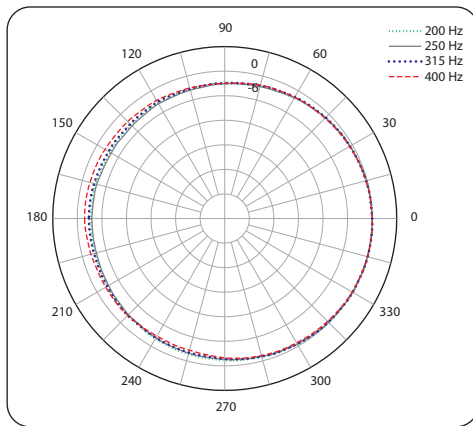

Install

# IMPACT TCI52-TR

2 Way 5" Full Range Loudspeaker with  
Line Transformer for Installation Applications  
(Weather Resistant)

## Dimensions

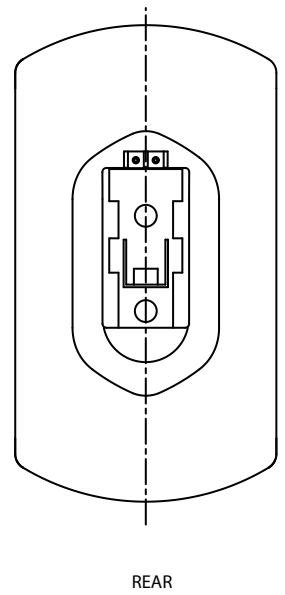
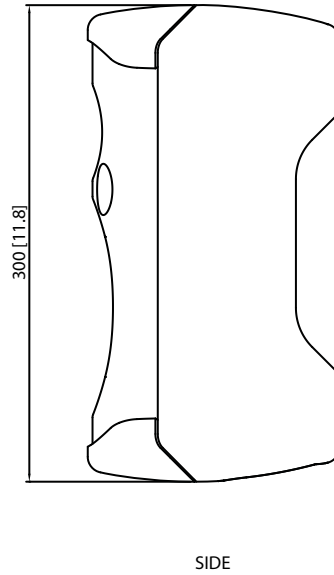
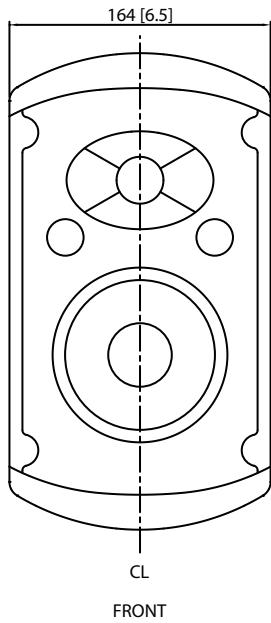
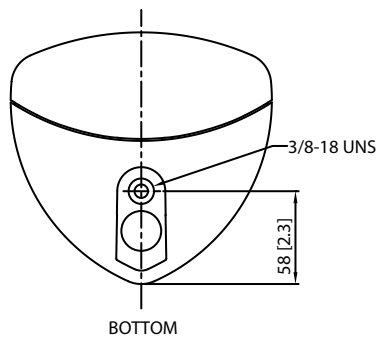
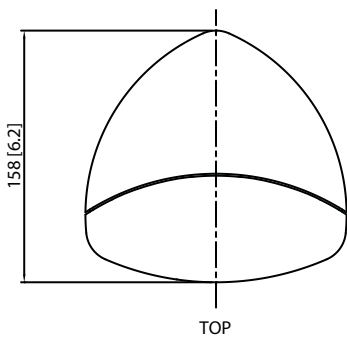



**Install**

# IMPACT

## TCI52-TR

2 Way 5" Full Range Loudspeaker with  
Line Transformer for Installation Applications  
(Weather Resistant)

### Technical Specifications

**System**

<b>Frequency response</b>	74 Hz - 20 kHz $\pm$ 3 dB 43 Hz - 20 kHz -10 dB
<b>Nominal dispersion</b>	100° H x 70° V @ -6 dB points
<b>Power handling (IEC)</b>	
Passive	60 W continuous, 240 W peak
100 V line	60, 30, 15 W continuous
70 V line	60, 30, 15, 7.5, 3.75 W continuous
<b>Sensitivity</b>	90 dB (1 W @ 1 m)
<b>Maximum SPL</b>	
Passive	108 dB continuous, 114 dB peak
100 V line	114, 111, 108 dB peak
70 V line	114, 111, 108, 105 dB peak
<b>Impedance</b>	16 $\Omega$
<b>Components</b>	1 x 5" (127 mm) LF driver 1 x 1" (25 mm) HF soft dome driver

**Enclosure**

<b>Connectors</b>	Screw terminal block
<b>Wiring</b>	Input +VE, -VE
<b>Dimensions HWD</b>	300 x 164 x 158 mm (11.8 x 6.5 x 6.2")
<b>Net weight</b>	3.5 kg (7.7 lbs)
<b>Construction</b>	Gas injected, glass-filled moulded ABS enclosure
<b>Finish</b>	Black (white optional)
<b>Grille</b>	Powder coated perforated Zinc plated steel
<b>Flying hardware</b>	M6 x 2 points

**Accessories**

Wall bracket - included

## Install

# IMPACT TCI52-TR

2 Way 5" Full Range Loudspeaker with  
Line Transformer for Installation Applications  
(Weather Resistant)

## Architecture & Engineering Specifications

The system shall be of the passive two-way type consisting of one 5" (127 mm) low frequency driver and one 1" (25 mm) ferro-fluid cooled neodymium high frequency tweeter with integral line transformer and shall be supplied with an adjustable wall bracket providing integral electrical connections. The loudspeaker shall be weather resistant for outdoor use, to rating standard IP34. Performance specifications of a typical production unit shall meet or exceed the following: Frequency response, measured with swept sine wave input, shall be flat within  $\pm 3$  dB from 74 Hz to 20 kHz, and within -10 dB from 43 Hz to 20 kHz. Nominal dispersion, at -6 dB points, shall average  $100^\circ$  H x  $70^\circ$  V. Nominal impedance shall be 16 ohms. Power handling shall be 60 watts continuous, 240 Watts peak. Sensitivity, measured with 1 Watt input at 1 metre distance on axis, mean averaged over stated bandwidth shall be 90 dB. Maximum SPL (peak) measured with music program input at stated amplifier power shall be 114 dB. Dimensions: 300 mm high x 164 mm wide x 158 mm deep (11.8" x 6.5" x 6.2"). Net weight: 3.5 kg (7.7 lbs). The loudspeaker system shall be the [TURBOSOUND IMPACT TCI52-TR](#). No other loudspeaker shall be acceptable unless submitted data from an independent test laboratory verifies that the above combined performance / size specifications are equalled or exceeded.

Install

# IMPACT TCI52-TR

2 Way 5" Full Range Loudspeaker with  
Line Transformer for Installation Applications  
(Weather Resistant)



Install

# IMPACT TCI52-TR

2 Way 5" Full Range Loudspeaker with  
Line Transformer for Installation Applications  
(Weather Resistant)



Install

# IMPACT TCI52-TR

2 Way 5" Full Range Loudspeaker with  
Line Transformer for Installation Applications  
(Weather Resistant)



For service, support or more information contact the TURBOSOUND location nearest you:

**Europe**  
**MUSIC Tribe Brands UK Ltd.**  
Tel: +44156 273 2290  
Email: CARECrea@music-group.com  
CAREEnte@music-group.com  
CARELife@music-group.com

**USA/Canada**  
**MUSIC Tribe Commercial NV Inc.**  
Tel: +1 702.800 8290  
Email: CARECrea@music-group.com  
CAREEnte@music-group.com  
CARELife@music-group.com

**Japan**  
**MUSIC Tribe Services JP K.K.**  
Tel: +81 3 6231 0453  
Email: CARECrea@music-group.com  
CAREEnte@music-group.com  
CARELife@music-group.com

MUSIC Tribe accepts no liability for any loss which may be suffered by any person who relies either wholly or in part upon any description, photograph, or statement contained herein. Technical specifications, appearances and other information are subject to change without notice. All trademarks are the property of their respective owners. MIDAS, KLARK TEKNIK, LAB GRUPPEN, LAKE, TANNÖY, TURBOSOUND, TC ELECTRONIC, TC HELICON, BEHRINGER, BUGERA and COOLAUDIO are trademarks or registered trademarks of MUSIC Group IP Ltd.  
© MUSIC Group IP Ltd. 2018 All rights reserved.